



CARDIOID PRESETS
AVAILABLE with external
Amate Audio amplifier & DSP



MULTIPLE PRESETS
AVAILABLE with external
Amate Audio amplifier & DSP



**HIGH RESISTANCE
POLYUREA PAINT®**



**ACCESSORIES FOR
EASY INSTALLATIONS**

A new expression of the compact and powerful 18" subwoofer! The cabinet design with laminar ports gets the most of the latest technology 18" transducer, making this subwoofer an ideal companion to any of the NITID series cabinet.

KEY FEATURES

TRANSDUCERS TECHNOLOGY

Passive subwoofer composed by one direct radiating 4-inch voice coil, 18" loudspeaker front loaded in a bass-reflex tuned enclosure with laminar ports.

POWER & CONTROL

2400 W continuous power in musical program.

Connectors are placed on an inclined plane to effectively protect them against rain or moisture.

Double Speakon NL4MPR® (input & link).

Recommended presets available for DSP206, DSP608 and TPD.

Cardioid presets available for DSP206 and DSP608.

DESIGN & ACCESSORIES

Ergonomic handles for an easy handling.

2 mm speaker grille with black mesh, exclusively designed with an optimum perforation gradient and attractive appearance.

Multilayer birch plywood cabinet with Polyurea® coating, offering maximum reliability and strength for touring as well as for high demanding applications.

M6 rigging points for easy flying.

M20 plate socket provided at the top side for full-range enclosure coupling.

TECHNICAL FEATURES

Power (musical program)	2400 W
Power (r.m.s)	1200 W
Nominal Impedance	8 Ω
SPL(1W/1m)	98 dB
Maximum SPL (continuous/1m)	132 dB
Maximum SPL (peak/1m)	135 dB
Crossover frequency (recommended)	80 Hz / 90 Hz / 100 Hz / 110 Hz / 120 Hz
Frequency Response (-10dB)	35 Hz – 150 Hz (with external DSP)
Components	LF
	1x 18" woofer (4" voice coil)
Directivity (H x V)	Omnidirectional
Directivity factor (Q)	1
Directivity Index (DI)	0 dB
Weight	49 kg
Finish	Multilayer birch plywood with high resistant black Polyurea® coating
Dimensions (H x W x D)	540 x 664 x 700 mm
Grille	2 mm steel with black acoustic mesh
Rigging	M6 points (for KR-18T flying hardware)
Connectors	1x Speakon NL4MPR input / 1x Speakon NL4MPR link

DISCOVER NÍTiD

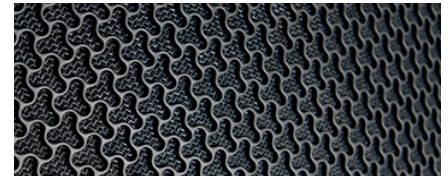

UNIQUE DESIGN

Distinguishing details include the speaker grille, exclusively designed for an attractive appearance, maximum protection, and with **the best performance coefficient in the market, for improved sound quality**. The Polyurea® finish offers durable protection for the birch-ply cabinet. A wide range of accessories is provided for whatever your application is.



THE PERFECT BALANCE

NÍTiD series is the culmination of an intensive program of research, development and optimization, to achieve the greatest possible power and performance from the most compact sized cabinet. Every aspect of its form factor has resulted from examination and consideration of optimum acoustic response, ergonomics, construction and appearance.



SIDE VIEW



FRONT VIEW WITHOUT GRILLES



REAR VIEW



BOTTOM VIEW



TOP VIEW

RECOMMENDED PRESETS with external Amate Audio DSP

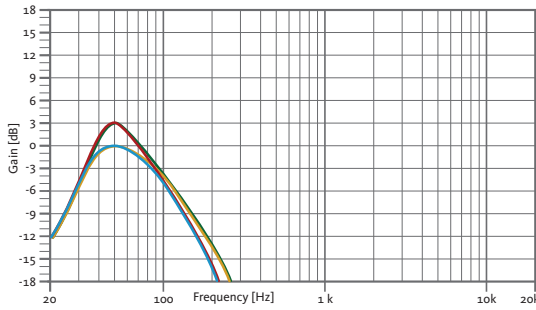

- LPF80**
LPF 80 Hz
- LPF80+3**
LPF 80 Hz + 3dB boost @ 50Hz
- LPF90**
LPF 90 Hz
- LPF90+3**
LPF 90 Hz + 3dB boost @ 50Hz
- LPF100**
LPF 100 Hz
- LPF100+3**
LPF 100 Hz + 3dB boost @ 50Hz

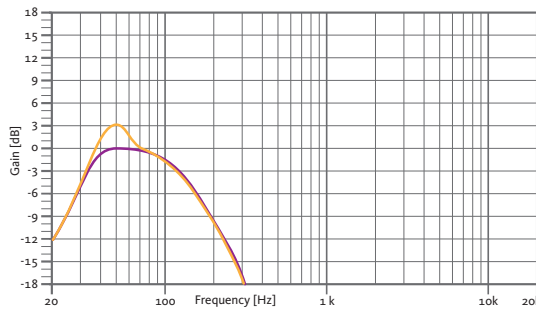
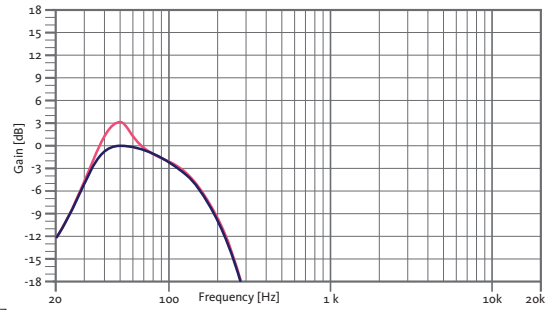

- LPF110**
LPF 110 Hz
- LPF110+3**
LPF 110 Hz + 3dB boost @ 50Hz
- LPF120**
LPF 120 Hz
- LPF120+3**
LPF 120 Hz + 3dB boost @ 50Hz

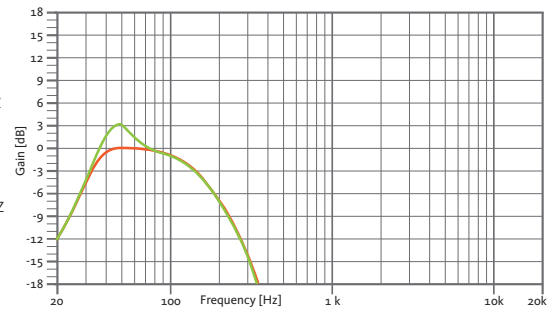

FREQUENCY RESPONSE 1w/1m (LPF90+3 PRESET)
with external Amate Audio DSP & HD4000 amplifier

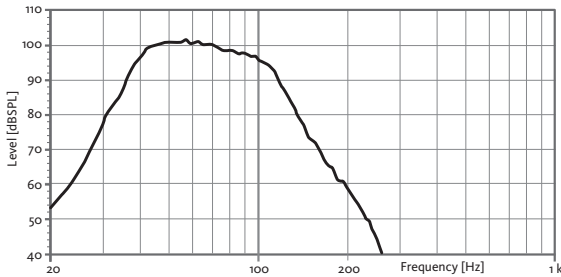

CAD DRAWING SCHEME

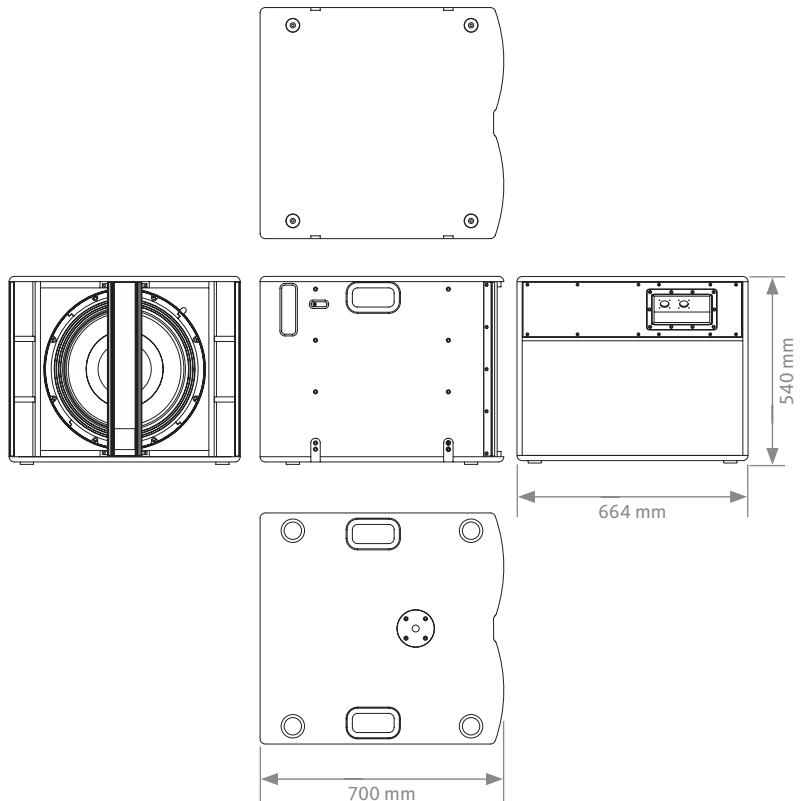

EASY CARDIOID CONFIGURATION
THROUGH AVAILABLE PRESETS

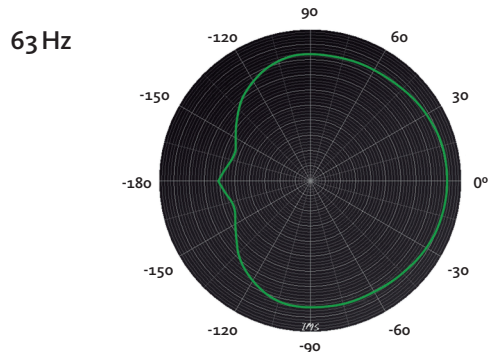

N18WP

2400 W
1x 18" PASSIVE
SUBWOOFER

NiTiD



ACCESSORIES

FLIGHT CASE FC-N18W/1
for one unit of N18WP



TOURING BUMPER TA-X208R
For flying N18WP



STACKING N18WP WITH N208
FR-X18 + FR-X208

FLYING N18WP WITH N208
TA-X208R + KR-18T

DISTANCE ROD M20 SP-CRTL
ø: 35 mm
Length: 55 cm ~ 90 cm
Thread: M20



STACKING FRAME FR-X18
For N18WP underneath N208



PROTECTIVE COVER NC-N18W
For one unit of N18WP



FLYING HARDWARE KR-18T
For flying N18WP

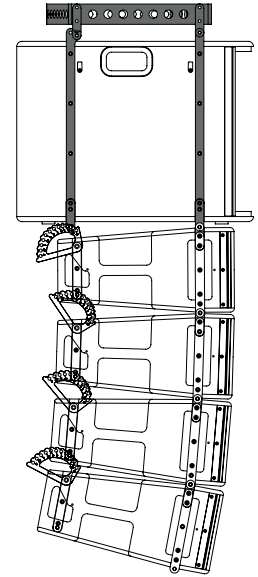
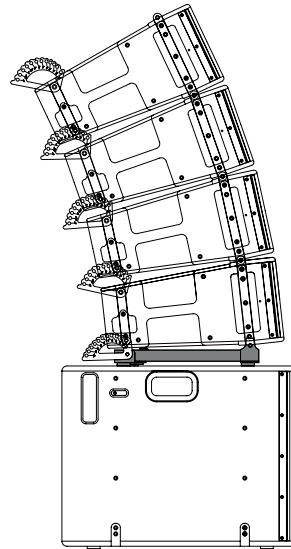

RECOMMENDED CONFIGURATION

Use one amplifier for the low reinforcement units and consequently, connect the Full Range cabinets to a second amplifier.



DSP206 or DSP608

HD3200 Stereo mode



HD4000 bridge mode



N12P/N15P



N12P/N15P

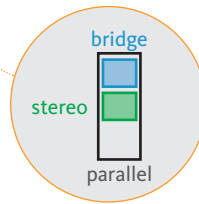

N18WP



N18WP

THE BEST COMBINATION

The best experience of NITID passive systems is reached with Amate Audio's HD Series amplifiers ,TPD amplifier and DSP206/608 digital signal processors. Factory presets are available to setup the system in a short time.



TPD Series



HD Series



DSP Series