

**8x8 Video Matrix Switch + Audio**  
**VM0808**  
**User Manual**



## FCC Information

This is an FCC Class A product. In a domestic environment this product may cause radio interference in which case the user may be required to take adequate measures.

This equipment has been tested and found to comply with the limits for a Class A digital device, pursuant to Part 15 of the FCC Rules. These limits are designed to provide reasonable protection against harmful interference when the equipment is operated in a commercial environment. This equipment generates, uses and can radiate radio frequency energy and, if not installed and used in accordance with the instruction manual, may cause harmful interference to radio communications. Operation of this equipment in a residential area is likely to cause harmful interference in which case the user will be required to correct the interference at his own expense.

## RoHS

This product is RoHS compliant.

## Safety

This product has been classified as Information Technology Equipment.

## SJ/T 11364-2006

The following contains information that relates to China.

部件名称	有毒有害物质或元素					
	铅	汞	镉	六价铬	多溴联苯	多溴二苯醚
电器部件	●	○	○	○	○	○
机构部件	○	○	○	○	○	○

- : 表示该有毒有害物质在该部件所有均质材料中的含量均在SJ/T 11363-2006规定的限量要求之下。
- : 表示符合欧盟的豁免条款, 但该有毒有害物质至少在该部件的某一均质材料中的含量超出SJ/T 11363-2006的限量要求。
- ×: 表示该有毒有害物质至少在该部件的某一均质材料中的含量超出SJ/T 11363-2006的限量要求。



## User Information

---

### Online Registration

Be sure to register your product at our online support center:

International	<a href="http://support.aten.com">http://support.aten.com</a>
North America	<a href="http://www.aten-usa.com/product_registration">http://www.aten-usa.com/product_registration</a>

### Telephone Support

For telephone support, call this number:

International	886-2-8692-6959
China	86-10-5255-0110
Japan	81-3-5615-5811
Korea	82-2-467-6789
North America	1-888-999-ATEN ext 4988
United Kingdom	44-8-4481-58923

### User Notice

All information, documentation, and specifications contained in this manual are subject to change without prior notification by the manufacturer. The manufacturer makes no representations or warranties, either expressed or implied, with respect to the contents hereof and specifically disclaims any warranties as to merchantability or fitness for any particular purpose. Any of the manufacturer's software described in this manual is sold or licensed *as is*. Should the programs prove defective following their purchase, the buyer (and not the manufacturer, its distributor, or its dealer), assumes the entire cost of all necessary servicing, repair and any incidental or consequential damages resulting from any defect in the software.

The manufacturer of this system is not responsible for any radio and/or TV interference caused by unauthorized modifications to this device. It is the responsibility of the user to correct such interference.

The manufacturer is not responsible for any damage incurred in the operation of this system if the correct operational voltage setting was not selected prior to operation. **PLEASE VERIFY THAT THE VOLTAGE SETTING IS CORRECT BEFORE USE.**

## Package Contents

---

The VM0808 package consists of:

- ◆ 1 VM0808 8x8 Video Matrix Switch
- ◆ 1 Power Cord
- ◆ 1 IR Remote Control
- ◆ 1 IR Receiver
- ◆ 1 Mounting Kit
- ◆ 1 User Instructions\*

Check to make sure that all the components are present and that nothing got damaged in shipping. If you encounter a problem, contact your dealer.

Read this manual thoroughly and follow the installation and operation procedures carefully to prevent any damage to the unit, and/or any of the devices connected to it.

---

\* Features may have been added to the VM0808 since this manual was published. Please visit our website to download the most up-to-date version.

---

© Copyright 2012 ATEN® International Co., Ltd.  
Manual Date: 2012-11-14

ATEN and the ATEN logo are registered trademarks of ATEN International Co., Ltd. All rights reserved.  
All other brand names and trademarks are the registered property of their respective owners.

# Contents

---

FCC Information . . . . .	ii
RoHS . . . . .	ii
Safety . . . . .	ii
SJ/T 11364-2006 . . . . .	ii
User Information . . . . .	iii
Online Registration . . . . .	iii
Telephone Support . . . . .	iii
User Notice . . . . .	iii
Package Contents . . . . .	iv
Contents . . . . .	v
About this Manual . . . . .	vii
Conventions . . . . .	viii
Product Information . . . . .	viii
<b>1. Introduction</b>	
Overview . . . . .	1
Features . . . . .	2
Requirements . . . . .	3
Source Devices . . . . .	3
Display Devices . . . . .	3
Cables . . . . .	3
Source Device Operating Systems . . . . .	4
Components . . . . .	5
Front View . . . . .	5
Rear View . . . . .	6
IR Remote Control . . . . .	7
<b>2. Hardware Setup</b>	
Rack Mounting . . . . .	8
Cable Connections . . . . .	10
<b>3. Operation</b>	
Overview . . . . .	11
Front Panel Operation . . . . .	11
Basic Navigation . . . . .	11
Menu Organization . . . . .	12
Enter Password . . . . .	13
Main Screen . . . . .	14
Video In Selection . . . . .	14
Independent Audio In Selection . . . . .	15
Set Serial Port . . . . .	16
Default Serial Settings . . . . .	16
Baud Rate . . . . .	16

Exit .....	17
Operation Mode .....	18
Power on Detection .....	18
EDID .....	19
Security Mode .....	20
Password Settings .....	20
Save / Load Profile .....	22
Profile Selection .....	23
Remote Control Operation .....	26
Change the Input source of an Output port .....	26
Power on/off individual Output displays .....	26
Power on/off all Output displays .....	27

#### **4. RS-232 Commands**

Serial Control Protocol Commands .....	28
Configuring the Serial Port .....	28
Switch Port Commands: .....	28
EDID Commands: .....	30
Mute Commands: .....	31
Save / Load Profile Commands: .....	32

#### **Appendix**

Safety Instructions .....	34
General .....	34
Rack Mounting .....	36
Technical Support .....	37
International .....	37
North America .....	37
Specifications .....	38
Limited Warranty .....	39

## About this Manual

---

This User Manual is provided to help you get the most from your VM0808 system. It covers all aspects of installation, configuration and operation. An overview of the information found in the manual is provided below.

**Chapter 1, Introduction,** introduces you to the VM0808 system. Its purpose, features and benefits are presented, and its front/back panel, and remote control components are described.

**Chapter 2, Hardware Setup,** describes how to set up your VM0808 installation and all the necessary steps.

**Chapter 3, Operation,** explains the fundamental concepts involved in operating the VM0808 via the front panel LCD display, and with the IR remote control.

**Chapter 4, RS-232 Protocol Commands,** provides a complete list of the serial control protocol commands used when utilizing the RS-232 Serial Port so that an extra source device can function further as transmitter and receiver.

**An Appendix,** provides specifications and other technical information regarding the VM0808.

## Conventions

---

This manual uses the following conventions:

- `Monospaced` Indicates text that you should key in.
- [ ] Indicates keys you should press. For example, [Enter] means to press the **Enter** key. If keys need to be chorded, they appear together in the same bracket with a plus sign between them: [Ctrl+Alt].
1. Numbered lists represent procedures with sequential steps.
- ◆ Bullet lists provide information, but do not involve sequential steps.
- Indicates selecting the option (on a menu or dialog box, for example), that comes next. For example, Start → Run means to open the *Start* menu, and then select *Run*.
-  Indicates critical information.

## Product Information

---

For information about all ATEN products and how they can help you connect without limits, visit ATEN on the Web or contact an ATEN Authorized Reseller. Visit ATEN on the Web for a list of locations and telephone numbers:

International	<a href="http://www.aten.com">http://www.aten.com</a>
North America	<a href="http://www.aten-usa.com">http://www.aten-usa.com</a>



# Chapter 1

## Introduction

### Overview

---

The ATEN VanCryst VM0808 8x8 Video Matrix Switch + Audio allows you to connect eight VGA source devices to eight VGA monitors, displays, or projectors- at the same time. It's vastly unique features include: fast source/display switching, IR remote control switching, unlimited matrix connections, Power On Detection for automatic display-loss prevention, RS-232 for high-end controllers, and independent audio matrix capabilities.

The VM0808 is a smart audio/video solution that offers an easy and affordable way to route any of 8 audio/video sources to any of 8 audio/displays, in any matrix combination.

As a Matrix Switch, each input can be independently connected to any or all outputs, and the audio inputs from each source device can also be switched independently, giving you the ultimate in flexibility and control in any multi-display audio/video installation.

Furthermore, for more complete systems integrations, the VM0808's includes a built-in RS-232 port that allows the switch to be controlled through a high-end controller or PC.

## Features

---

- ◆ Connects any of 8 VGA Video + Audio inputs to any of 8 VGA Video + Audio outputs
- ◆ Long signal range – supports up to 30 meters
- ◆ Easily switch between multiple sources and multiple displays
- ◆ Operation:
  - ◆ Front panel LCD display and pushbuttons
  - ◆ Tuner Dials with pushbutton
  - ◆ RS-232 Serial controller
  - ◆ IR Remote Control
- ◆ Superior video quality – up to 1920 x 1440; VGA, SVGA, SXGA, UXGA, and WUXGA (1920 x 1200)
- ◆ Features EDID expert technology to set up different video configurations via different EDID modes
- ◆ Supports up to 500 MHz bandwidth
- ◆ Supports stereo audio
- ◆ Independent switching of audio and video sources – each input can be independently connected to any or all outputs for flexibility
- ◆ Power On Detection - If one of the video sources is powered off the VM0808 automatically switches to the next powered-on source
- ◆ Cascade Additional VM0808 Units up to three levels
- ◆ Rack Mountable
- ◆ All metal casing

---

**Note:** The VM0808 RS-232 AP and GUI instructions can be downloaded from the ATEN website: [www.aten.com](http://www.aten.com).

---

## **Requirements**

---

The following equipment is required for a complete VM0808 installation

### **Source Devices**

- ♦ Computer or A/V source device with VGA and stereo output

### **Display Devices**

- ♦ A VGA, SVGA, XGA, SXGA, UXGA, WUXGA, or multisync display device with an HDB-15 connector
- ♦ Stereo speakers

### **Cables**

- ♦ Use VGA/Audio/RS-232 cables to connect the computer (or other audio/video source device) to the VM0808

---

**Note:** Cables are not provided in the VM0808 package.

---

## **Source Device Operating Systems**

Supported operating systems are shown in the table, below:

<b>OS</b>		<b>Version</b>
Windows		2000 and higher
Linux	RedHat	6.0 and higher
	SuSE	8.2 and higher
	Mandriva (Mandrake)	9.0 and higher
UNIX	AIX	4.3 and higher
	FreeBSD	3.51 and higher
	Sun	Solaris 8 and higher
Novell	Netware	5.0 and higher
Mac		OS 9 and higher
DOS		6.2 and higher

# Components

## Front View

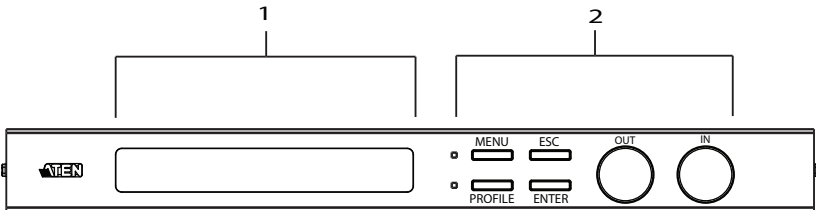

No.	Component	Description
1	LCD Display	The LCD display shows the various options for configuring and operating the VM0808. For full details, see <i>Front Panel Operation</i> , page 11.
2	Front Panel Pushbuttons and Tuner Dials	<p>Use the pushbuttons to navigate the LCD display to configure and operate the VM0808.</p> <ul style="list-style-type: none"> <li>◆ MENU – Press to invoke the Menu page/Main Screen</li> <li>◆ PROFILE – Press to switch between the video source Profile Selection list</li> <li>◆ ESC – Press to cancel the current selection or exit without saving changes</li> <li>◆ ENTER – Press to confirm the current selection</li> <li>◆ Tuner Dials - IN &amp; OUT to navigate up, down, left, and right or scroll selected options within the LCD display.</li> </ul> <p>For full details, see <i>Front Panel Operation</i>, page 11.</p> <p><b>Note:</b> The MENU and PROFILE front panel pushbuttons have built-in LEDs that light to indicate they have been selected.</p>

## Rear View

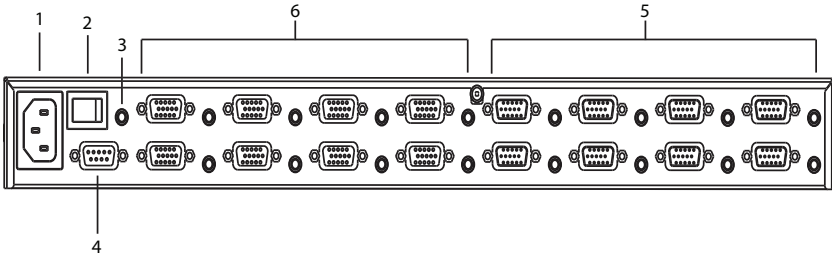

No.	Component	Description
1	Power Socket	This is a standard 3-pin AC power socket. The power cord from an AC source plugs in here.
2	Power Switch	This is a standard rocker switch that powers the unit on and off.
3	External IR Receiver Port	3.5 mm Mini Stereo Jack which connects the IR Receiver unit included with your product.
4	RS-232 Serial Port	This serial remote port is for input source selection and high-end system control.
5	Audio/Video Input Ports	The VGA ports are for connecting your input source. The Mini Stereo Jack ports are for the audio source.
6	Audio/Video Output Ports	The VGA ports are for connecting your output displays. The Mini Stereo Jack ports are for the audio speakers.

## IR Remote Control

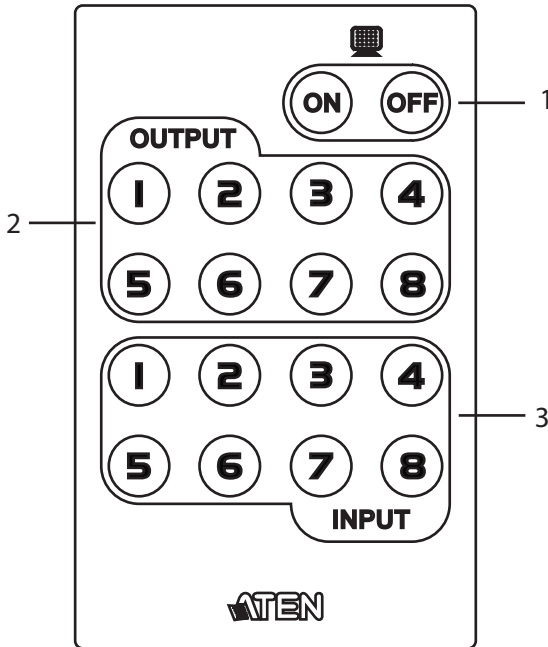

No.	Component	Description
1	Power ON/OFF	Use the ON and OFF pushbuttons to turn the Output displays on or off- by individual port, or all ports. (see <i>Remote Control Operation</i> , page 26)
2	Output Pushbuttons 1–8	Output display Pushbutton 1–8 to change Input source for Output displays. (see <i>Remote Control Operation</i> , page 26)
3	Input Pushbuttons 1–8	Input source Pushbutton 1–8 to change Input source of an Output display. (see <i>Remote Control Operation</i> , page 26)

# Chapter 2

## Hardware Setup



1. Important safety information regarding the placement of this device is provided on page 34. Please review it before proceeding.
2. Make sure that the power to all devices connected to the installation are turned off. You must unplug the power cords of any computers that have the Keyboard Power On function.

### Rack Mounting

---

The VM0808 can be mounted in a 19" (1U) system rack. For the most convenient front panel configuration and operation, mount the unit at the front of the rack, as follows:

1. Use the M3 x 8 Phillips head hex screws supplied with the Rack Mount Kit to screw the rack mounting brackets onto the front of the unit.

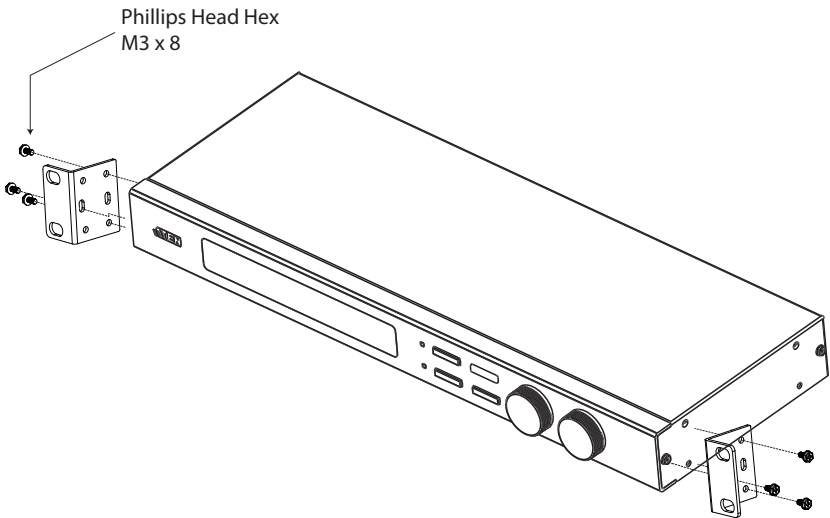

*(Continues on next page.)*



2. Position the unit in the front of the rack and align the holes in the mounting brackets with the holes in the rack.
3. Screw the mounting brackets to the rack.

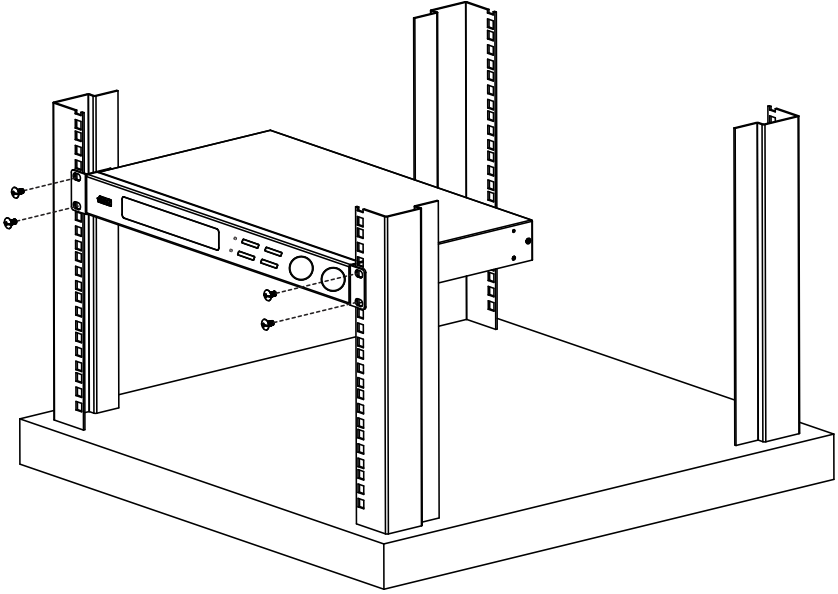

## Cable Connections

Installation of the VM0808 is simply a matter of connecting the appropriate cables. Refer to the installation diagram below (the numbers in the diagrams correspond to the steps, below), and do the following:

1. If you are using the serial control function, use an appropriate RS-232 serial cable to connect the computer or serial controller to the VM0808's female RS-232 port.
2. Connect up to 8 video/audio sources to the VGA/Audio Input ports
3. Connect up to 8 display/audio devices to the VGA/Audio Output ports
4. Connect the IR Receiver into the External IR Receiver Input Port
5. Plug the power cord supplied with the package into the VM0808's 3-prong AC socket, and then into an AC power source.
6. Power on the VM0808 and all devices in the installation.

### Installation Diagram

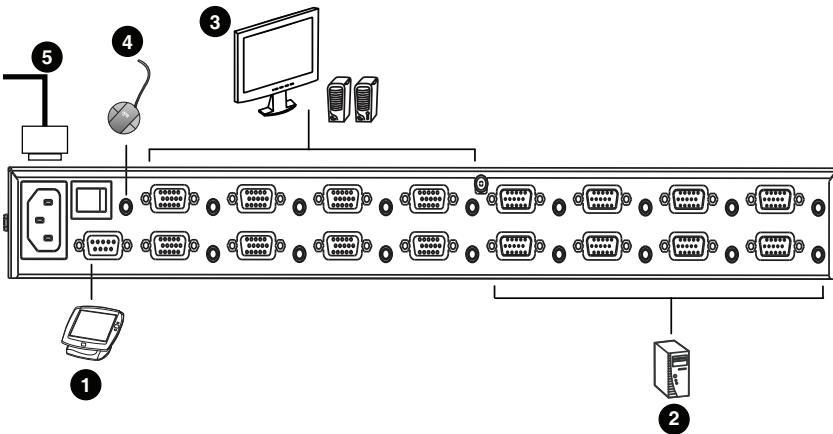

# Chapter 3

## Operation

### Overview

---

The VM0808 can be configured and operated via the front panel pushbuttons and tuner dials, IR Remote Control or by connecting an RS-232 Serial controller.

### Front Panel Operation

---

The VM0808 features front panel pushbuttons, tuner dials and an LCD display panel for convenient configuration and operation. This allows you to perform operations such as selecting which source displays on which display, selecting independent audio, configuring the serial port, adjusting the Power On Detection and EDID modes, setting security information, loading/saving profiles, and setting up the Profile Selection list.

### Basic Navigation

The VM0808's front panel display operation is easy and convenient. Please note the following front panel button and dial operations:

- ◆ Use the MENU pushbutton to access the Menu page options: Switch Audio only, Set Serial Port, Operation Mode, Security Mode, Save/Load Profile, and Profile Selection.
- ◆ Use the PROFILE pushbutton on the Main screen to switch between connection Profiles, set in Profile Selection.
- ◆ Use the ESC pushbutton to go back a level, return to the Main page, or exit.
- ◆ Use the ENTER or Tuner Dial pushbuttons to select options and confirm operations.
- ◆ Use the Tuner IN/OUT dials to cycle forwards or backwards through the menus or options.

## Menu Organization

Use the MENU pushbutton to switch between the Main Screen and Menu page. From the Main screen press the MENU pushbutton to access the Menu page and cycle through the menu options using the tuner dials, starting from Switch Audio Only, in the order show in the table, below:

Menu Page	Sub-Menu Page(s)	
Password		
Main Page	Select Video IN	1-8, or N/A
	Profile	Pressing PROFILE cycles through the Profiles added to the Profile Selection list
Switch Audio Only	Select Audio IN	1-8, or N/A
Set Serial Port	Default Serial Setting	Yes / No
	Baud Rate	9600 / 19200 / 38400 / 115200
Operation Mode	Power On Detection	Off / On
	EDID	Auto/ Default / Port1 / Remix
Security Mode	Password Required	Yes / No
	Change Password	Old Password   New Password
Save / Load Profile	Save to a Profile No	0-31
	Call a Saved Profile No	
Profile Selection	Show Profile Selection	List of Profiles in Profile Selection
	Add a Profile in Selection	Add a Profile No 0-31
	Delete a Profile from Selection	Delete a Profile No

## Enter Password

If the VM0808 has been configured to require a password for operation (see *Security Mode*, page 20), the password screen appears when the unit is accessed for operations, and the first digit flashes. Enter a 4-digit password to continue to the Main Screen.

---

**Note:** If you are accessing the VM0808 for the first time, the default password is 1234.

---

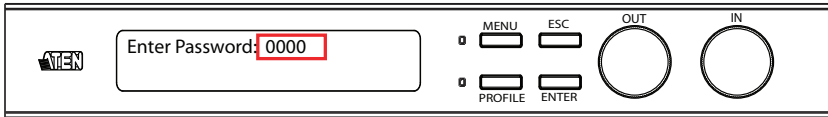

To enter a password, do the following:

1. Turn the front panel OUT dial left or right to move the cursor position.
2. Turn the front panel IN dial left or right to cycle through the numbers.
3. Press and Release the OUT, IN, or ENTER pushbutton to confirm the password and continue to the Main Screen.

---

**Note:** 1. If you enter an incorrect password, re-enter the correct password over the incorrect string.

2. If Password Required (see *Password Settings*, page 20) is enabled, the time-out is 5 minutes.

---

## Main Screen

The Main screen displays Output Ports 1–8 in sequential order across the top. The Input source displaying on each Output port is shown directly beneath it. From the Main screen, you can set the Input to Output connections that route the signals from a selected Input port to the selected Output port. To do so you simply change the Input source associated for each Output display.

From the Main screen; pressing the PROFILE pushbutton cycles through the connection Profiles setup in Profile Selection, pressing the MENU pushbutton accesses the Menu page options. Pressing the ESC or MENU pushbutton at anytime returns you to the Main screen.

## Video In Selection

To select which input source displays on each output port, from the main screen do the following:

1. Turn the OUT dial to select an output port's corresponding input port.

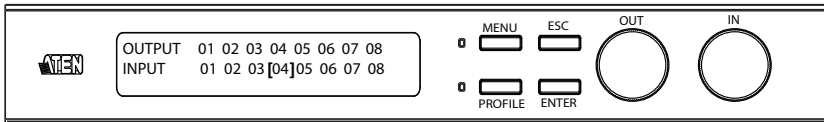

2. When the cursor [ ] highlights your selected input port, use the IN dial to cycle through the available input sources.  
Options are: Ports 1–8, NA (none)
3. Press the OUT, IN, or ENTER pushbutton to confirm your selection. The VGA signal from the selected input port is now tied to the output port above it.
4. Repeat steps 1–3 for all required ports.

---

**Note:** This operation ties two signals (audio, video) from a selected input to a selected output port. For independent switching of the audio signal, see the following section, *Independent Audio In Selection*, page 15.

---

## Independent Audio In Selection

The audio signal can be switched independently of the video signal, to use with any other audio ports connection, using the Switch Audio Only menu. To create an independent audio connection, from the Main Screen do the following:

1. Press the Menu pushbutton to access the Menu page, and select [ENTER] Switch Audio Only.

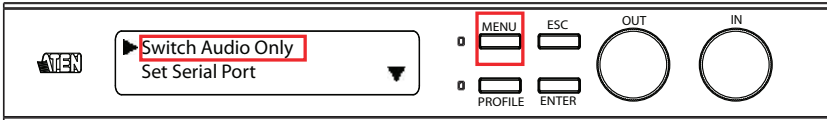

2. Use the OUT turner dial to select the desired Input port, corresponding to the Output port's audio you would like to change.

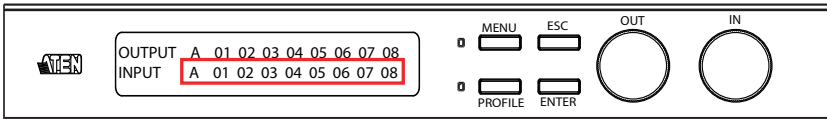

3. When the cursor [ ] highlights your selected input port, use the IN dial to cycle through the available audio Input sources, to associated it to the Output port above it.

Options are Ports 1–8, NA (none).

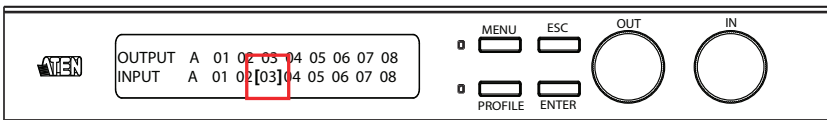

4. Press OUT, IN, or ENTER pushbuttons to confirm your selection to switch audio to the selected port.
5. Press ESC to return to the Menu page.

## Set Serial Port

To configure the VM0808's serial settings, from the Main screen press the Menu pushbutton to access the Menu page, and select [ENTER] Set Serial Port:

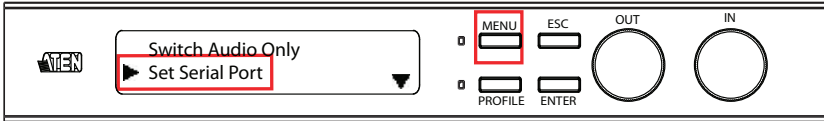

The sub-menu provides two options: Default Serial Setting, and Baud Rate, as follows:

### Default Serial Settings

To load the Default Serial Settings, do the following:

1. With the arrow on Default Serial Setting, press and release the OUT, IN, or ENTER pushbutton to access the options. The Default Serial Setting option flashes.

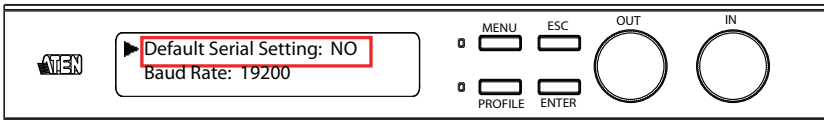

2. Turn the front panel IN/OUT dial left or right to select Yes or No.
3. Press and Release the OUT, IN, or ENTER pushbutton to confirm the change.

---

**Note:** The default serial setting is No.

---

### Baud Rate

To set the VM0808's baud rate, do the following:

1. Select [ENTER] Baud Rate from the Set Serial Port submenu. The Baud Rate options flash:



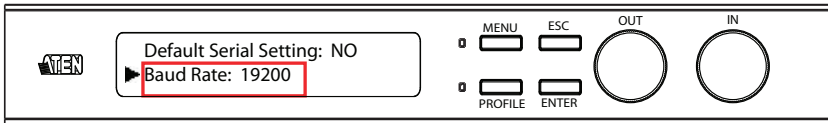

2. Turn the front panel IN/OUT dial to cycle through the options.  
Options are 9600, 19200, 38400, and 115200
3. Press and release the OUT, IN, or ENTER pushbutton to confirm the Baud Rate.

---

**Note:** The default baud rate is 19200.

---

## Exit

After each operation, you can either:

- ◆ *Press ESC or MENU to return to the Menu page;*
- ◆ *Press ESC or MENU until your returned to the Main screen*

## Operation Mode

The Power On Detection and EDID features are adjusted from the Operation Mode menu. The Power on Detection mode automatically switches an Output port to the next powered-on source if its video source is powered off. EDID (extended display identification data) is used to automatically or manually setup different video configurations via EDID modes to utilize the best resolution across different monitors.

To adjust the Power On Detection mode, or EDID, from the Main screen do the following:

### Power on Detection

1. Use the MENU button to access the Menu page, turn the OUT/IN dial to scroll down and select [ENTER] Operation Mode:

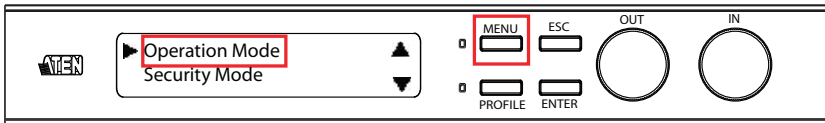

2. With the arrow on Power On Detection, press and release the OUT, IN, or ENTER pushbutton to access the Power On Detection options.

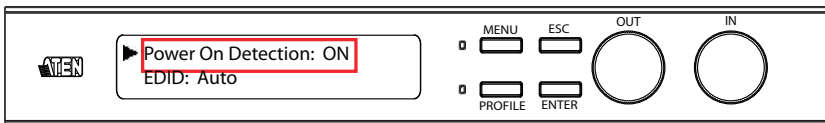

3. Turn the front panel OUT/IN dial to cycle through On or Off.
4. Press and Release the OUT, IN, or ENTER pushbutton to confirm the change.

---

**Note:** The default Power On Detection setting is OFF.

---

## EDID

1. Use the MENU button to access the Menu page, turn the OUT/IN dial to scroll down and select [ENTER] Operation Mode:

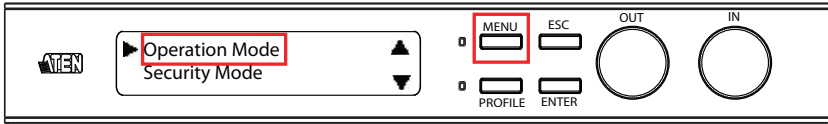

2. Turn the IN/OUT dial to move the arrow to the EDID position, and press the OUT, IN, or ENTER pushbutton to select EDID.

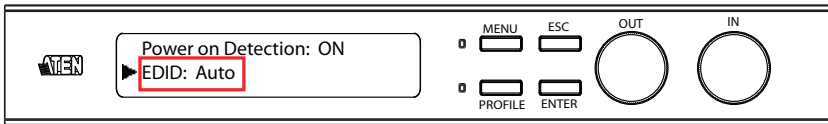

3. Turn the front panel OUT/IN dial to cycle through the options; Auto, Default, Port1, or Remix.
4. Press and Release the OUT, IN, or ENTER pushbutton to confirm the change.

EDID Option	Description
Auto	All connected display's EDID are detected and the best resolution for it is used as its connected.
Default	The default EDID will be passed to all video displays.
Port1	The EDID from port1 will be passed to all video displays.
Remix	Uses the EDID of each connected display according to its connection when the VM0808 was first powered on.

**Note:** The default EDID setting is Default.

## Security Mode

The Security Mode page allows you to configure the VM0808's password related settings; Password Required and Change Password. The Password Required option sets the VM0808 to require a password for operation after the unit times out (default: 5 minutes) or is powered off/on. The Change Password option allows you to set a new password for the VM0808.

## Password Settings

To configure the VM0808's password settings, from the Main screen do the following:

1. Use the MENU button to access the Menu page, turn the OUT/IN dial to scroll down and select [ENTER] Security Mode.

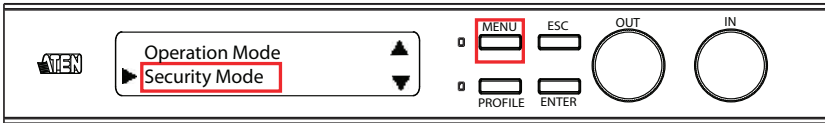

2. To set the VM0808 to require a password for operation, select [ENTER] Password Required, and turn the IN/OUT dial to select Yes or No and press the OUT, IN, or ENTER pushbutton to confirm.

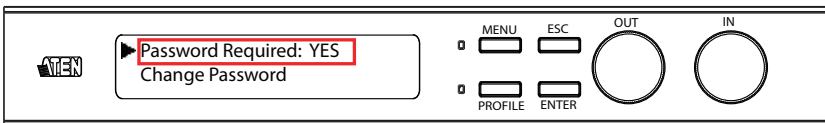

3. To change the password, use the IN/OUT dial to move the arrow to Change Password and press the OUT, IN, or ENTER pushbutton to select.

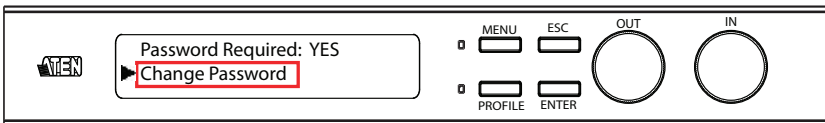

4. Enter the old password (see *Enter Password*, page 13). Then, press the OUT, IN, or ENTER pushbutton to create a New Password, and enter the new password in the same way.

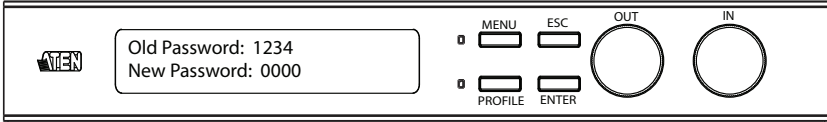

5. Press and Release the OUT, IN, or ENTER pushbutton to confirm the password and continue to the Main Screen.

---

**Note:** If you enter an incorrect password, re-enter the correct password over the incorrect string.

---

## Save / Load Profile

The VM0808 allows you to store up to 32 (numbered 0–31) different connection profiles that can be saved and recalled later. When profiles are saved, they are saved according to the current connection configuration on the Main screen. When you load a profile the change is immediate and the profile number is shown in the lower right corner of the display on the Main screen. To save/load profiles, from the Main screen do the following:

1. Use the MENU button to access the Menu page, turn the OUT/IN dial to scroll down and select [ENTER] Save/Load Profile.

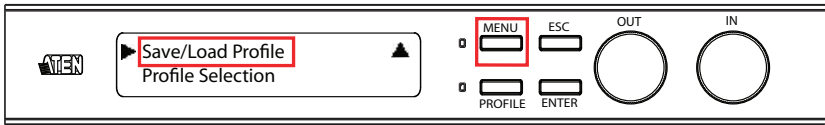

2. To save the current connection configuration as a profile, select [ENTER] Save to a Profile No, turn the IN/OUT dial to cycle through the numbers (0–31), and press the OUT, IN, or ENTER pushbutton to save the profile as the number you select.

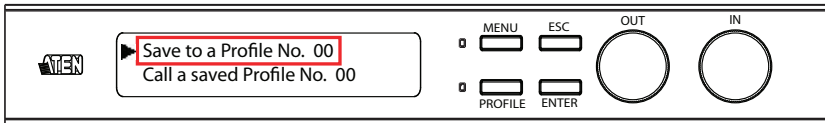

3. To load a Saved Profile, select [ENTER] Call a Saved Profile No, turn the IN/OUT dial to cycle through the profiles (0–31) and press the OUT, IN, or ENTER pushbutton to select the profile to load.

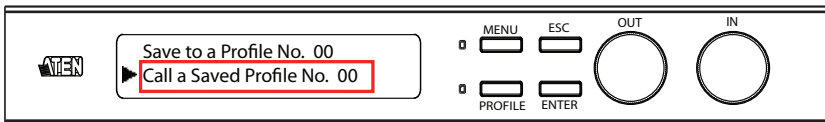

## Profile Selection

Profile selection allows you to set a series of profiles to cycle through using the PROFILE pushbutton from the Main screen. Once you have added profiles to the Profile Selection list- from the Main screen you can press the PROFILE pushbutton to switch between the profiles in the Profile Selection list.

To add, delete, or show the Profile Selection list, from the Main screen do the following:

### To Add a Profile in Selection:

1. Use the MENU button to access the Menu page, turn the OUT/IN dial to scroll down and select [ENTER] Profile Selection.

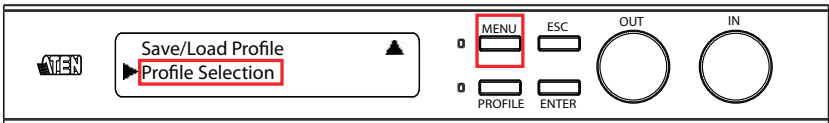

2. Use the OUT/IN dial to select [ENTER] Add a Profile in Selection:

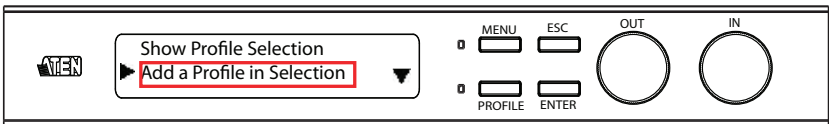

3. Use the OUT/IN dial to scroll through the profile numbers, and press [ENTER] to add a profile number to the Profile Selection list.

Options are Profiles 00–31

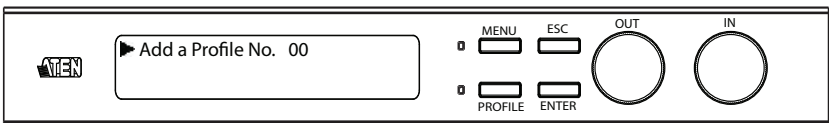

Profiles can be added in any order, and cycle in the order they are added.

**To Delete a Profile from Selection:**

1. Use the MENU button to access the Menu page, turn the OUT/IN dial to scroll down and select [ENTER] Profile Selection.

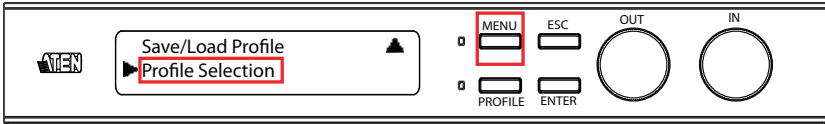

2. Use the OUT/IN dial to scroll down and select [ENTER] Delete a Profile from Selection:

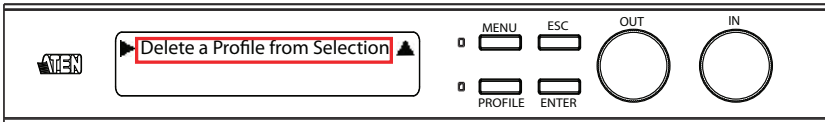

3. Use the OUT/IN dial to scroll through the profile numbers, and press [ENTER] to delete a profile from the Profile Selection list.

Options are Profiles 00–31

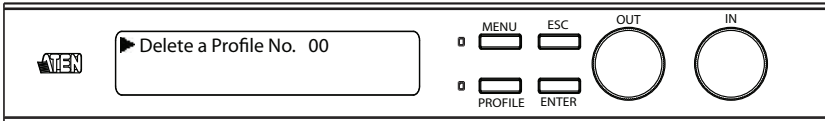



**To Show Profile Selection:**

Use the MENU button to access the Menu page, turn the OUT/IN dial to scroll down and select [ENTER] Profile Selection.

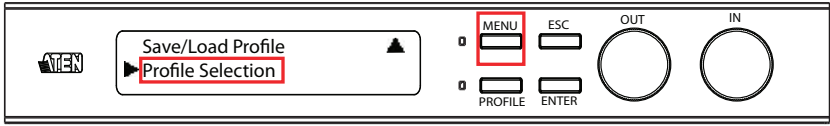

4. Use the OUT/IN dial to select [ENTER] Show Profile Selection:

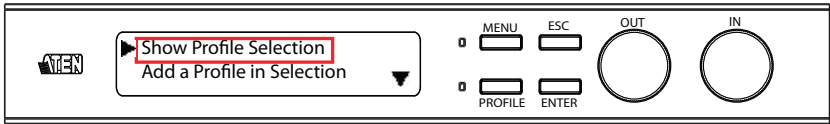

5. The Profiles added to the Profile Selection list will show in the order which they were added.

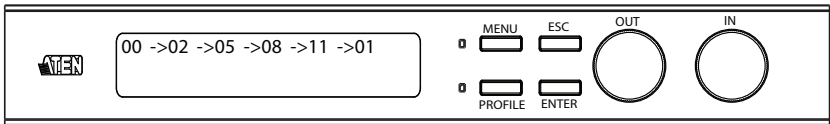

## **Remote Control Operation**

---

The remote control allows you to change the Output port status for each display using the IR remote control device included with your VM0808.

You can use the remote control to: change the Input source of any Output display port, power on/off any individual Output display, or power on/off all Output displays simultaneously.

Before using the remote control feature you must first plug the IR External Receiver into the rear of the VM0808 (see *External IR Receiver Port*, page 6), and place the receiver where the IR signal can be reached.

### **Change the Input source of an Output port**

To change the Input source for an Output display, use the remote control to do the following:

1. Press the OUTPUT port number (1–8) you want to change.
2. Press the INPUT port number (1–8) you want the OUTPUT port to display within 2 seconds.\*
3. Repeat steps 1-2 to change additional ports.

\*For the change to occur the INPUT number must be pressed within 2 seconds of pressing the OUTPUT number.

### **Power on/off individual Output displays**

To power on/off individual Output displays, use the remote control to do the following:

1. Press the OUTPUT port number (1–8) you want to power on/off.
2. Press the ON or OFF pushbutton within 2 seconds.\*
3. Repeat steps 1-2 to change the power status back on/off.

\*For individual power on/off to occur properly the ON or OFF pushbutton must be pressed within 2 seconds of pressing the OUTPUT number. Failing to do so will result in all displays being powered on or off respectively.

**Power on/off all Output displays**

To power on/off all Output displays simultaneously\*, use the remote control to do the following:

1. Press the ON or OFF pushbutton.
2. Repeat step 1 to simultaneously change the power status of all Output ports back on/off.

\*Using the ON or OFF pushbutton brings all Output ports to the same power status, regardless of current individual (on/off) power statuses.

# Chapter 4

## RS-232 Commands

### Serial Control Protocol Commands

---

This chapter provides a complete list of the serial control protocol commands used when utilizing the RS-232 Serial Port so that an extra source device can function further as transmitter and receiver.

### Configuring the Serial Port

The controller's serial port should be configured as follows:

RS-232 Serial Control Protocol Settings	
Baud Rate	19200 (Default)
Data Bit	8 bits
Parity	None
Stop Bit	1 Bit
Flow Control	None

### Switch Port Commands:

The formulas for Switch Port commands are as follows:

1. Switch Command + Input Command + Port number + Output Command + Port Number + Control + [Enter]

For example, to switch input port 02 (audio and video) to output port 05 on device 01, type the following:

**sw i02 o05 [Enter]**

2. Switch Command + Output Command + Port Number + Control + [Enter]

For example, to turn off video output on port 03, type the following:

**sw o03 video off [Enter]**

*(Continues on next page.)*

## 3. Switch Command + Output Command + Port Number + Control + [Enter]

For example, to switch the next output to the local port, type the following:

**sw l1 + [Enter]**

### Possible Values

The following table shows the possible values for switch commands:

Command	Description	
sw	Switch command	
Input Command	Description	
i	Input command	
Input Port Number	Description	
xx	01-08 port (default is 01)	
l1	Local input port	
Output Command	Description	
o	Output Command	
Output Port Number	Description	
yy	01-08 port (default is 01)	
l1	Local output port	
*	All output ports	
Control	Description	
on	Turn on	
off	Turn off	
+	Next port	
-	Previous port	
video	Switch video only	skip = video+audio
audio	Switch audio only	
Enter	Description	
[Enter]	Enter and send out the command	

**Switch Port Command Table:**

Cmd	In	N1	Out	N2	C1	C2	Enter	Description
sw	i	xx	o	yy *	video audio		Enter Key	Switch Input Port xx to Output Port yy (xx:01~08; yy:01~08, *)
sw			o	yy *	video audio	on off	Enter Key	Turn on Output Port yy Turn off Output Port yy (yy:01~08, *)
sw			o	yy *	video audio	+ -	Enter Key	Switch Next Input to Output Port yy Switch Previous Input to Output Port yy (yy:01~08, *)

**Acknowledge:**

Ack	Description
Command OK	Command is correct and function executed
Command Incorrect	Unavailable command or parameters

After commands are sent acknowledge messages are returned.

**Note:** 1. Each command string can be separated with a space.

2. The **Port Number** command string can be skipped, and the default value will be used.
3. The **Audio or Video** command string can be skipped, and both values will be used.

**EDID Commands:**

The formulas for EDID commands are as follows:

1. EDID Command + Control + [Enter]

For example, to change EDID to use the port1 setting, type the following:

**edid port1 [Enter]**

## Possible Values

The following table shows the possible values for switch commands:EDID

Command	Description
edid	EDID mode selection

Control	Description
port1	Implement all display's EDID according to port1
remix	Use the EDID of the connected displays -according to the connection when first powered on.
auto	Use the EDID detected for each connection and set the best resolution for all.
default	Implement default EDID for all

Enter	Description
[Enter Key]	Send out command

## EDID Command Table

Command	Control	Enter	Description
edid	port1	[Enter Key]	The EDID from port1 will be passed to all video sources.
edid	remix	[Enter Key]	Uses the EDID of the connected display according to each connection when the VM0808 is powered on.
edid	auto	[Enter Key]	All connected displays EDID will be detected and the best resolution for all will be selected as they are connected.
edid	default	[Enter Key]	The default EDID will be passed to all video sources.

## Mute Commands:

The formulas for Mute commands are as follows:

1. Mute Command + Output Command + Port Number + Control + [Enter]

For example, to mute output port 05 on device 01, type the following:

**mute o05 on [Enter]**

2. Mute Command + Output Command + Port Number + Control + [Enter]

For example, turn on audio at output port 05 on device 01, type the following:

**mute o05 off [Enter]**

## Possible Values

The following table shows the possible values for mute commands: Commands

Command	Description
mute	Mute selected output port

Control	Description
on	Mute on; audio from selected output port is disabled
off	Mute off; audio output enabled (default)

## Mute Command Table

Command	Output	Num2	Control	Enter	Description
mute	o	yy	on	[Enter Key]	Mute Output Port yy (yy:01~08, *) (Default: *)
mute	o	yy	off	[Enter Key]	Turn on Audio at Output Port yy (yy:01~08, *) (Default: *)

---

**Note:** Each command string can be separated with a space.

---

## Save / Load Profile Commands:

The formulas for Save/Load Profile commands are as follows:

1. Command + Profile + Number + Control + [Enter]

For example, to save the current connection configuration to profile 12, type the following:

**profile f 12 save [Enter]**

2. Command + Profile + Number + Control + [Enter]

For example, to load profile 12, type the following:

**profile f 12 load [Enter]**



## Possible Values

The following table shows the possible values for Save/load Profile commands:

Command	Description
profile	Save / Load profile

Profile	Description
f	Profile

Profile Number	Description
yy	00-31 (default is 00)

Control	Description
save	Save the current connection configuration
load	Load a saved profile

## Profile Command Table:

Command	Profile	Num1	Control	Enter	Description
profile	f	yy	save	[Enter Key]	Save current connection configuration to profile yy (yy:00~31) (Default: 00)
profile	f	yy	load	[Enter Key]	Load saved profile yy (yy:00~31) Default: 00)

## Acknowledge:

Ack	Description
Command OK	Command is correct and function executed
Command Incorrect	Unavailable command or parameters

After commands are sent acknowledge messages are returned.

## Safety Instructions

---

### General

- ◆ Read all of these instructions. Save them for future reference.
- ◆ Follow all warnings and instructions marked on the device.
- ◆ Do not place the device on any unstable surface (cart, stand, table, etc.). If the device falls, serious damage will result.
- ◆ Do not use the device near water.
- ◆ Do not place the device near, or over, radiators or heat registers.
- ◆ The device cabinet is provided with slots and openings to allow for adequate ventilation. To ensure reliable operation, and to protect against overheating, these openings must never be blocked or covered.
- ◆ The device should never be placed on a soft surface (bed, sofa, rug, etc.) as this will block its ventilation openings. Likewise, the device should not be placed in a built in enclosure unless adequate ventilation has been provided.
- ◆ Never spill liquid of any kind on the device.
- ◆ Unplug the device from the wall outlet before cleaning. Do not use liquid or aerosol cleaners. Use a damp cloth for cleaning.
- ◆ The device should be operated from the type of power source indicated on the marking label. If you are not sure of the type of power available, consult your dealer or local power company.
- ◆ The device is designed for IT power distribution systems with 230V phase-to-phase voltage.
- ◆ To prevent damage to your installation it is important that all devices are properly grounded.
- ◆ The device is equipped with a 3-wire grounding type plug. This is a safety feature. If you are unable to insert the plug into the outlet, contact your electrician to replace your obsolete outlet. Do not attempt to defeat the purpose of the grounding-type plug. Always follow your local/national wiring codes.
- ◆ Do not allow anything to rest on the power cord or cables. Route the power cord and cables so that they cannot be stepped on or tripped over.

- ◆ If an extension cord is used with this device make sure that the total of the ampere ratings of all products used on this cord does not exceed the extension cord ampere rating. Make sure that the total of all products plugged into the wall outlet does not exceed 15 amperes.
- ◆ To help protect your system from sudden, transient increases and decreases in electrical power, use a surge suppressor, line conditioner, or un-interruptible power supply (UPS).
- ◆ Position system cables and power cables carefully; Be sure that nothing rests on any cables.
- ◆ Never push objects of any kind into or through cabinet slots. They may touch dangerous voltage points or short out parts resulting in a risk of fire or electrical shock.
- ◆ Do not attempt to service the device yourself. Refer all servicing to qualified service personnel.
- ◆ If the following conditions occur, unplug the device from the wall outlet and bring it to qualified service personnel for repair.
  - ◆ The power cord or plug has become damaged or frayed.
  - ◆ Liquid has been spilled into the device.
  - ◆ The device has been exposed to rain or water.
  - ◆ The device has been dropped, or the cabinet has been damaged.
  - ◆ The device exhibits a distinct change in performance, indicating a need for service.
  - ◆ The device does not operate normally when the operating instructions are followed.
- ◆ Only adjust those controls that are covered in the operating instructions. Improper adjustment of other controls may result in damage that will require extensive work by a qualified technician to repair.

## **Rack Mounting**

- ◆ Before working on the rack, make sure that the stabilizers are secured to the rack, extended to the floor, and that the full weight of the rack rests on the floor. Install front and side stabilizers on a single rack or front stabilizers for joined multiple racks before working on the rack.
- ◆ Always load the rack from the bottom up, and load the heaviest item in the rack first.
- ◆ Make sure that the rack is level and stable before extending a device from the rack.
- ◆ Do not overload the AC supply branch circuit that provides power to the rack. The total rack load should not exceed 80 percent of the branch circuit rating.
- ◆ Make sure that all equipment used on the rack – including power strips and other electrical connectors – is properly grounded.
- ◆ Ensure that proper airflow is provided to devices in the rack.
- ◆ Ensure that the operating ambient temperature of the rack environment does not exceed the maximum ambient temperature specified for the equipment by the manufacturer.
- ◆ Do not step on or stand on any device when servicing other devices in a rack.

## Technical Support

---

### International

- ◆ For online technical support – including troubleshooting, documentation, and software updates: **<http://support.aten.com>**
- ◆ For telephone support, see *Telephone Support*, page iii:

### North America

Email Support		<a href="mailto:support@aten-usa.com">support@aten-usa.com</a>
Online Technical Support	Troubleshooting Documentation Software Updates	<a href="http://www.aten-usa.com/support">http://www.aten-usa.com/support</a>
Telephone Support		1-888-999-ATEN ext 4988

When you contact us, please have the following information ready beforehand:

- ◆ Product model number, serial number, and date of purchase.
- ◆ Your computer configuration, including operating system, revision level, expansion cards, and software.
- ◆ Any error messages displayed at the time the error occurred.
- ◆ The sequence of operations that led up to the error.
- ◆ Any other information you feel may be of help.

## Specifications

Function		VM0808
Connectors	Video In	8 x HDB-15 Male (Blue)
	Video Out	8 x HDB-15 Female (Blue)
	Audio In	8 x Mini Stereo Jack Female (Green)
	Audio Out	8 x Mini Stereo Jack Female (Green)
	RS-232	1 x DB9 Female (Black)
	IR Input Port	1 x Mini Stereo Jack Female (Black)
	Power	1 x 3-prong AC Socket
Switches	In	1 x Tuner Button
	Out	1 x Tuner Button
	Esc	1 x Pushbutton
	Menu	1 x Pushbutton
	Profile	1 x Pushbutton
	Enter	1 x Pushbutton
	Power	1 x Rocker
LEDs	Menu	1 (Green)
	Profile	1 (Green)
Video	Bandwidth	500 MHz
	Resolution	1920 x 1440 @ 60Hz
Power Consumption		120V, 7W; 230V, 8W
Environment	Operating Temp.	0–50°C
	Storage Temp.	-20–60°C
	Humidity	0–80% RH, Non-condensing
Physical Properties	Housing	Metal
	Weight	2.48 kg
	Dimensions (L x W x H)	43.72 x 16.85 x 4.40 cm

## **Limited Warranty**

---

IN NO EVENT SHALL THE DIRECT VENDOR'S LIABILITY EXCEED THE PRICE PAID FOR THE PRODUCT FROM DIRECT, INDIRECT, SPECIAL, INCIDENTAL, OR CONSEQUENTIAL DAMAGES RESULTING FROM THE USE OF THE PRODUCT, DISK, OR ITS DOCUMENTATION.

The direct vendor makes no warranty or representation, expressed, implied, or statutory with respect to the contents or use of this documentation, and especially disclaims its quality, performance, merchantability, or fitness for any particular purpose.

The direct vendor also reserves the right to revise or update the device or documentation without obligation to notify any individual or entity of such revisions, or update. For further inquiries, please contact your direct vendor.