



Simply Better Connections

ATEN VanCryst™

**VM3200 / VM3250**

32 x 32 Modular Matrix Switch  
User Manual

## Compliance Statements

### FEDERAL COMMUNICATIONS COMMISSION INTERFERENCE STATEMENT

This equipment has been tested and found to comply with the limits for a Class A digital device, pursuant to Part 15 of the FCC Rules. These limits are designed to provide reasonable protection against harmful interference when the equipment is operated in a commercial environment. This equipment generates, uses, and can radiate radio frequency energy and, if not installed and used in accordance with the instruction manual, may cause harmful interference to radio communications. Operation of this equipment in a residential area is likely to cause harmful interference in which case the user will be required to correct the interference at his own expense.

The device complies with Part 15 of the FCC Rules. Operation is subject to the following two conditions: (1) this device may not cause harmful interference, and (2) this device must accept any interference received, including interference that may cause undesired operation.

#### FCC Caution

Any changes or modifications not expressly approved by the party responsible for compliance could void the user's authority to operate this equipment.

#### Warning

Operation of this equipment in a residential environment could cause radio interference.

#### Achtung

Der Gebrauch dieses Geräts in Wohnumgebung kann Funkstörungen verursachen.



### KCC Statement

유선 제품용 / A 급 기기 (업무용 방송 통신 기기)  
 이 기기는 업무용 (A 급) 전자파적합기기로서 판매자 또는 사용자는 이  
 점을 주의하시기 바라며, 가정 외의 지역에서 사용하는 것을 목적으로  
 합니다.

### **HDMI Trademark Statement**

The terms HDMI, HDMI High-Definition Multimedia Interface, and the HDMI Logo are trademarks or registered trademarks of HDMI Licensing Administrator, Inc.



### **RoHS**

This product is RoHS compliant.

## About this Manual

---

This user manual is provided to help you get the most from your VM3200 / VM3250, I/O boards, and compatible receivers, which includes the following the following product models:

Device Type	Model	Product Name
Modular Matrix Switch	VM3200	32 x 32 Modular Matrix Switch
	VM3250	32 x 32 Modular Matrix Switch Gen. 2
Input / Output Board	VM7584 / VM8584	4-Port 10G Optic Input / Output Board
	VM7514 / VM8514	4-Port HDBaseT Input / Output Board
	VM7904	4-Port 4K DisplayPort Input Board
	VM7824 / VM8824	4-Port True 4K HDMI Input Board / Output Board
	VM7814 / VM8814	4-Port 4K HDMI Input / Output Board
	VM7804 / VM8804	4-Port HDMI Input / Output Board
	VM7604 / VM8604	4-Port DVI Input / Output Board
	VM7104	4-Port VGA Input Board
	VM7404	4-Port 3G-SDI Input Board
Video Receiver	VE805R	HDMI HDBaseT Lite Receiver with Scaler
	VE816R	4K HDMI HDBaseT Receiver with Scaler

This manual covers all aspects of installation, configuration and operation of the VM3200 / VM3250 Modular Matrix system. An overview of the information found in the manual is provided below.

**Chapter 1 Introduction** introduces you to the VM3200 / VM3250 and its components. Its purpose, features and benefits are presented, and its front and back panel components are described.

**Chapter 2 Hardware Setup** describes how to set up the hardware for your Modular Matrix Solution installation.

**Chapter 3 Front Panel Operation** explains the fundamental concepts involved in operating the VM3200 / VM3250 at the local site via the front panel LCD display using pushbuttons.

**Chapter 4 Browser Operation** provides a complete description of the Modular Matrix Solution's web Graphical User Interface (GUI), and how to use it to remotely configure and operate the Modular Matrix Solution.

**Chapter 5 CLI Commands** provides a complete list of the serial control protocol commands used when utilizing the RS-232 Serial Port so that an extra source device can be utilized in the installation.

**Appendix** provides specifications and other technical information regarding the VM3200 / VM3250.

---

**Note:**

- ◆ Read this manual thoroughly and follow the installation and operation procedures carefully to prevent any damage to the device or to any other connected devices.
  - ◆ The VM3200 / VM3250 product firmware may have been updated with new features after the release of this manual. For an up-to-date VM3200 / VM3250 user manual, visit <http://www.aten.com/global/en/>
- 

## **Conventions**

This manual uses the following conventions:

- |   |  |
|---|--|
| Monospaced  | Indicates text that you should key in.   |
| [ ]   | Indicates keys you should press. For example, [Enter] means to press the <b>Enter</b> key. If keys need to be chorded, they appear together in the same bracket with a plus sign between them: [Ctrl+Alt]. |
| 1.  | Numbered lists represent procedures with sequential steps.   |
| ◆   | Bullet lists provide information, but do not involve sequential steps.   |
| >   | Indicates selecting the option (on a menu or dialog box, for example), that comes next. For example, Start > Run means to open the <i>Start</i> menu, and then select <i>Run</i> .                         |
|  | Indicates critical information.  |

## **Package Contents**

---

Check to make sure that all of the components are present and in good order. If anything is missing or was damaged in shipping, contact your dealer.

### **VM3200**

The VM3200 package consists of:

- ◆ 1 VM3200 Modular Matrix Switch
- ◆ 1 power module
- ◆ 1 power cord
- ◆ 1 terminal block
- ◆ 1 user instructions

### **VM3250**

The VM3250 package consists of:

- ◆ 1 VM3250 32 x 32 Modular Matrix Switch Gen. 2
- ◆ 1 power module
- ◆ 1 power cord
- ◆ 1 terminal block
- ◆ 1 user instructions

### **VM7584 / VM8584**

The **K1** package (300 m) consists of:

- ◆ 1 VM7584 4-Port 10G Optical Input Board or  
VM8584 4-Port 10G Optical Output Board
- ◆ 4 SFP+ modules
- ◆ 4 3-pole terminal blocks
- ◆ 1 IR receiver
- ◆ 1 IR emitter
- ◆ 1 user instructions

The **K2** package (10 km) consists of:

- ◆ 1 VM7584 4-Port 10G Optical Input Board or VM8584 4-Port 10G Optical Output Board
- ◆ 4 SFP+ modules
- ◆ 4 3-pole terminal blocks
- ◆ 1 IR receiver
- ◆ 1 IR emitter
- ◆ 1 user instructions

### **VM7514 / VM8514**

The 4-Port HDBaseT Input / Output Board package consists of:

- ◆ 1 VM7514 4-Port HDBaseT Input Board / 1 VM8514 4-Port HDBaseT Output Board
- ◆ 4 terminal blocks
- ◆ 1 IR transmitter
- ◆ 1 IR receiver
- ◆ 1 user instructions

### **VM7904**

The 4-Port 4K DisplayPort Input Board package consists of:

- ◆ 1 VM7904 4-Port 4K DisplayPort Input Board
- ◆ 4 terminal blocks
- ◆ 1 user instructions

### **VM7824 / VM8824**

The 4-Port True 4K HDMI Input / Output Board package consists of:

- ◆ 1 VM7824 4-Port True 4K HDMI Input Board / 1 VM8824 4-Port True 4K HDMI Output Board
- ◆ 4 terminal blocks
- ◆ 1 user instructions

### **VM7814 / VM8814**

The 4-Port 4K HDMI Input / Output Board package consists of:

- ◆ 1 VM7814 4-Port 4K HDMI Input Board / 1 VM8814 4-Port 4K HDMI Output Board
- ◆ 4 terminal blocks
- ◆ 4 HDMI LockPro
- ◆ 1 user instructions

### **VM7804 / VM8804**

The 4-Port HDMI Input / Output Board package consists of:

- ◆ 1 VM7804 4-Port HDMI Input Board / 1 VM8804 4-Port HDMI Output Board
- ◆ 4 terminal blocks
- ◆ 1 user instructions

### **VM7604 / VM8604**

The 4-Port DVI Input / Output Board package consists of:

- ◆ 1 VM7604 4-Port DVI Input Board / 1 VM8604 4-Port DVI Output Board
- ◆ 4 terminal blocks
- ◆ 1 user instructions

### **VM7104**

The 4-Port VGA Input Board package consists of:

- ◆ 1 VM7104 4-Port VGA Input Board
- ◆ 4 terminal blocks
- ◆ 1 user instructions



**VM7404**

The 4-Port 3G-SDI Input Board package consists of:

- ◆ 1 VM7404 4-Port 3G-SDI Input Board
- ◆ 4 terminal blocks
- ◆ 1 user instructions

**VE805R**

The HDMI HDBaseT Lite Receiver with Scaler package consists of:

- ◆ 1 VE805R HDMI HDBaseT Lite Receiver with Scaler
- ◆ 1 power adapter
- ◆ 1 terminal block
- ◆ 1 IR transmitter
- ◆ 1 IR receiver
- ◆ 1 user instructions

**VE816R**

The 4K HDMI HDBaseT Receiver with Scaler package consists of:

- ◆ 1 VE816R 4K HDMI HDBaseT Receiver with Scaler
- ◆ 1 IR transmitter
- ◆ 1 IR receiver
- ◆ 1 terminal block
- ◆ 1 power adapter
- ◆ 1 user instructions

## **Product Information**

---

For information about all ATEN products and how they can help you connect without limits, visit ATEN on the Web or contact an ATEN Authorized Reseller. Visit ATEN on the Web for a list of locations and telephone numbers:

---

International	<a href="http://www.aten.com">http://www.aten.com</a>
---------------	---

---

## **User Information**

---

### **Online Registration**

Be sure to register your product at our online support center:

---

International	<a href="http://eservice.aten.com">http://eservice.aten.com</a>
---------------	---

---

### **Telephone Support**

For telephone support, call this number:

---

International	886-2-8692-6959
China	86-400-810-0-810
Japan	81-3-5615-5811
Korea	82-2-467-6789
North America	1-888-999-ATEN ext 4988 1-949-428-1111

---

## **User Notice**

All information, documentation, and specifications contained in this manual are subject to change without prior notification by the manufacturer. The manufacturer makes no representations or warranties, either expressed or implied, with respect to the contents hereof and specifically disclaims any warranties as to merchantability or fitness for any particular purpose. Any of the manufacturer's software described in this manual is sold or licensed *as is*. Should the programs prove defective following their purchase, the buyer (and not the manufacturer, its distributor, or its dealer), assumes the entire cost of all necessary servicing, repair and any incidental or consequential damages resulting from any defect in the software.

The manufacturer of this system is not responsible for any radio and/or TV interference caused by unauthorized modifications to this device. It is the responsibility of the user to correct such interference.

The manufacturer is not responsible for any damage incurred in the operation of this system if the correct operational voltage setting was not selected prior to operation. PLEASE VERIFY THAT THE VOLTAGE SETTING IS CORRECT BEFORE USE.

**Caution:** There is a risk of explosion if the battery is replaced by an incorrect type. Always dispose of used batteries according to the relevant instructions.

# Contents

---

Compliance Statements . . . . .	ii
About this Manual . . . . .	iv
Conventions . . . . .	v
Package Contents . . . . .	vi
VM3200 . . . . .	vi
VM3250 . . . . .	vi
VM7584 / VM8584 . . . . .	vi
VM7514 / VM8514 . . . . .	vii
VM7904 . . . . .	vii
VM7824 / VM8824 . . . . .	vii
VM7814 / VM8814 . . . . .	viii
VM7804 / VM8804 . . . . .	viii
VM7604 / VM8604 . . . . .	viii
VM7104 . . . . .	viii
VM7404 . . . . .	ix
VE805R . . . . .	ix
VE816R . . . . .	ix
Product Information . . . . .	x
User Information . . . . .	x
Online Registration . . . . .	x
Telephone Support . . . . .	x
User Notice . . . . .	xi
Contents . . . . .	xii

## 1. Introduction

Overview . . . . .	1
Features . . . . .	5
VM3200 / VM3250 . . . . .	5
VM7584 / VM8584 . . . . .	7
VM7514 / VM8514 . . . . .	8
VM7904 . . . . .	9
VM7824 / VM8824 . . . . .	10
VM7814 / VM8814 . . . . .	11
VM7804 / VM8804 . . . . .	12
VM7604 / VM8604 . . . . .	13
VM7104 . . . . .	14
VM7404 . . . . .	14
VE805R . . . . .	15
VE816R . . . . .	16
Requirements . . . . .	17
Input / Output Board . . . . .	17
Source Devices . . . . .	17
Display Devices . . . . .	18
Cables . . . . .	18

Compatible Browsers .....	19
.....	19
Optional Equipment .....	19
Components .....	20
VM3200 / VM3250 Front View .....	20
VM3200 / VM3250 Rear View .....	22
Power Module .....	23
VM7584 Front View .....	24
VM8584 Front View .....	25
VM7514 Front View .....	26
VM8514 Front View .....	26
VM7904 Front View .....	27
VM7824 Front View .....	27
VM8824 Front View .....	28
VM7814/VM7804 Front View .....	28
VM8814/VM8804 Front View .....	29
VM7604 Front View .....	29
VM8604 Front View .....	30
VM7104 Front View .....	30
VM7404 Front View .....	31
VE805R / VE816R Front View .....	32
<b>2. Hardware Setup</b>	
Transporting and Storing the Unit .....	33
Rack Mounting .....	34
Mounting with Brackets .....	35
Installation .....	37
Installing the Input / Output Boards .....	39
<b>3. Front Panel Operation</b>	
Overview .....	43
Front Panel Pushbuttons .....	43
Basic Navigation .....	43
Front Panel LCD .....	44
LCD Password .....	44
Port Switching .....	46
Video / Audio Pushbutton .....	46
Port Selection .....	47
Input Port Selection .....	47
Output Port Selection .....	49
Profile Pushbutton .....	51
LCD Menu .....	52
LCD Main Screen .....	53
IP Setting .....	54
Serial Port Setting .....	55
Baud Rate .....	55

Operation Mode .....	56
EDID .....	56
CEC .....	57
OSD .....	58
Output Status .....	59
Security Mode .....	61
Mode .....	61
Change Password .....	62
Playing/Stopping the Profile Schedule .....	64
Enabling/Disabling the Standby Mode .....	64
Breaking Output Groups .....	65

## 4. Browser Operation

Overview .....	67
Logging In .....	67
Main Page .....	68
Menu Bar .....	69
Setting the Standby Mode .....	69
Profiles .....	70
Understanding Profiles and Profile List .....	70
Understanding Display Zones .....	71
Example .....	71
Creating a Profile .....	72
Configuring Video Settings of a Profile .....	75
Configuring Video Settings in Normal View .....	77
Profile Layout Settings .....	77
Display Preferences .....	78
Video Wall Settings .....	79
Configuring Video Settings in Grid View .....	83
Configuring Audio Output Settings .....	85
Playing a Profile .....	87
Apply Multiple Profiles by Batch .....	87
Apply A Single Profile .....	88
Change Input .....	90
Live Streaming View .....	91
Exporting a Profile .....	92
Importing a Profile .....	92
Streaming Out Videos Live .....	93
Preparation .....	93
Configuration .....	93
Profile Scheduling .....	96
Enabling/Disabling Profile Schedule .....	96
Adding Profile Playlists .....	98
Adding a Recurring Playlist .....	98
Adding a One-off Playlist .....	101
Editing, Removing, or Copying Profile Playlists .....	103

System Settings	104
Overview	104
General	107
Basics	107
System Time	107
Fan Status	107
Power Status	108
Serial Settings	108
Streaming Out	108
Port Settings	109
OSD/CEC	109
HDCP	111
Scaler	112
Customized Resolution	113
Port Name	116
EDID Settings	118
EDID Mode	119
EDID & CEA Description	120
Customized Mode	121
Customized EDID Parameters	122
CEA Settings	125
Video Data	126
Audio Data	127
HDMI Forum Vendor Specific Block	128
YCBCR 4:2:0 Video Data Block	129
YCBCR 4:2:0 Compatibility Map Data Block	130
Status	131
Connections	131
System Information	132
RS-232 Channel	133
Maintenance	135
System Setup	135
User Account	137
Add Account	138
Permission Level	139
Network	140

## 5. CLI Commands

Overview	141
Connecting to the Matrix Switch via Telnet	141
Connecting to the Matrix Switch via RS-232	142
Verification	143
Commands	143
Switch Port Command	143
Audio Commands	146
Mute Command	149

Volume Command .....	151
Load Profile Commands .....	153
EDID Mode Command .....	155
CEC Command .....	157
Read Command .....	158
Reset Command .....	160
Baud Rate Command .....	161
OSD Command .....	162
Echo Command .....	163
Scaling Command .....	164
Fan Speed Command .....	169
Alert Command .....	170
FrameSync Command .....	171
Long Reach Mode Command .....	172
Standby Mode Command .....	173
Schedule Command .....	174

## Appendix

Safety Instructions .....	177
General .....	177
Rack Mounting .....	179
Technical Support .....	180
International .....	180
Specifications .....	181
VM3250 .....	181
VM3200 .....	183
VM7584 / VM8584 .....	185
VM7514 / VM8514 .....	187
VM7904 .....	188
VM7824 / VM8824 .....	189
VM7814 / VM8814 .....	190
VM7804 / VM8804 .....	191
VM7604 / VM8604 .....	192
VM7104 .....	193
VM7404 .....	194
VE805R .....	195
VE816R .....	196
VM-PWR800 .....	197
VM-FAN556 .....	197
Telnet Operation .....	198
Configuration Menu .....	198
1. H – Call up the command list for help .....	198
2. IP – Set IP address .....	198
3. LO – Load connections from profile .....	198
4. PW – Change password .....	199
5. RI – Read what input is connected to nn output .....	199



6. RO – Read what output is connected to nn input . . . . .	199
7. SB – Set serial port baud rate . . . . .	199
8. SS – Switch input to specified output . . . . .	199
9. SV – Save the current connections into a profile . . . . .	199
10. TI – Set timeout . . . . .	199
11. VR – Software version information . . . . .	199
Limited Warranty . . . . .	200

This Page Intentionally Left Blank

# Chapter 1

## Introduction

### Overview

---

The ATEN Modular Matrix Switch (VM3200) / Modular Matrix Switch Gen. 2 (VM3250) offers advanced access and real-time control of multiple local and remote AV input devices and displays from a single chassis. The VM3200 / VM3250 allows users to independently switch and route video and/or audio content to various monitors, displays, and projectors. The built-in Scaler encodes the video format in order to provide seamless, real-time switching. High-quality video outputs are ensured with EDID Expert™, which selects the optimum resolutions.

The VM7584 and VM8584 (4-Port 10G Optical Input / Output Board) offer an easy way for the VM3200 / VM3250 to route 4 HDMI sources over long distances via optical extenders, the VE883 to 4 HDMI-enabled displays. These I/O boards are able to route uncompressed 4K signal to the VM3200 / VM3250 from up to 300 m (VM7584K1 and VM8584K1) or 10 km (VM7584K2 and VM8584K2) away over duplex fiber optic cables. On top of audio and video signal, the optical fiber also guarantees an interference-free long-haul transmission of IR and RS-232 control signals.

The VM7514 / VM8514 4-Port HDBaseT Input/Output Boards offers an easy way to route any of 4 HDBaseT audio/video sources to any of 4 HDBaseT display devices, in combination with the ATEN Modular Matrix Switch. When the VM8514 HDBaseT Output Board is used in conjunction with the VE805R HDBaseT Receiver or VE816R 4K HDMI HDBaseT Receiver with Scaler, it features Seamless Switch technology and video wall functionality.

The VM7904 is a 4-Port 4K DisplayPort Input Board that works with an ATEN Modular Matrix Switch to offer an easy way that routes 4 DisplayPort video and audio sources to up to 16 or 32 displays. In addition to the DisplayPort interface that carries digital AV signal, the VM7904 also provides 4 stereo audio input ports that allow stereo audio to be routed independently or embedded for HDMI output. Ideal for high-resolution video wall applications, the VM7904 effectively routes DisplayPort sources with 4K resolution up to

4096x2160@30Hz (4:4:4) and EDID Expert™ technology for the optimum resolutions across different displays.

The VM7814 / VM8814 is a 4-Port 4K HDMI input/output board that works with VM3200 / VM3250 to route 4 HDMI sources to 4 displays. The VM7814 / VM8814 is equipped with 4 input/output ports to allow for stereo audio embedding and audio extraction. The VM8814 supports Seamless Switch™ to ensure real-time video switching, a built-in 4K scaler to handle videos of different resolutions, and EDID Expert™ to ensure high video quality.

The VM7824/VM8824 is a True 4K HDMI input/output board that works with VM3250 to offer an easy way to route 4 HDMI audio/video sources to 4 displays with True 4K high-definition images. In addition to the HDMI interface that carries digital AV signal, the VM7824/VM8824 also provides 4 stereo audio input/output ports that enable stereo audio embedding or HDMI audio extraction.

---

**Note:** If the VM7824 and VM8824 are installed on the VM3200, the modular matrix will only support resolutions up to 4K 4:4:4@30Hz or 4:2:0@60Hz.

---

The VM7804 / VM8804 4-Port HDMI Input / Output Board is a hot-swappable I/O board that offers an easy way to route any of 4 audio/video sources to any of 4 displays and installs in the Modular Matrix Switch. The VM8804 supports Seamless Switch technology that provides video switching in real-time, a built in scaler that handles different video resolutions, and EDID Expert™ technology for fast smooth switching between displays. The VM7804 / VM8804 also supports separate stereo audio signals that can be routed independently and extracted from embedded HDMI audio signals.

The VM7604 / VM8604 4-Port DVI Input / Output Board is a hot-swappable I/O board that offers an easy way to route any of 4 audio/video sources to any of 4 displays and installs in the Modular Matrix Switch. The VM8604 supports Seamless Switch technology that provides video switching in real-time, a built in scaler that handles different video resolutions and EDID Expert™ technology for fast smooth switching between displays.

The VM7104 4-Port VGA Input Board offers an easy way to route 4 VGA video and audio sources to 4 displays and speakers. In addition, the VM7104 can be mixed with any modular output boards on the VM3200 / VM3250 for optimum flexibility.

The VM7404 is a 4-Port 3G-SDI input board provides the capability to connect to SDI sources, such as 3G-SDI, HD-SDI and SD-SDI, and supports high quality video resolutions up to 1080p @ 60Hz. The VM7404 also supports separate analog stereo audio signals for independent routing.

The VE805R HDMI HDBaseT Lite Receiver with Scaler / VE816R 4K HDMI HDBaseT Receiver with Scaler can be combined with an ATEN HDMI HDBaseT transmitter or splitter to extend your HDMI display up to 100 m from the source using a single Cat 6a cable or ATEN 2L-2910 Cat 6 cable. With a built-in scaler, the VE805R / VE816R supports the scaling of different video resolutions. When combined with ATEN HDBaseT output boards, it supports video wall functionality. In addition, the VE805R / VE816R is equipped with RS-232 and IR signaling pass-through which allows RS-232 and IR channel control from the remote to local unit, to control the HDMI source, or from the local to remote unit, to control the display device. The VE805R / VE816R is HDCP compliant.

Combining these devices, this solution can be conveniently customized, allowing users to independently switch and route video and/or audio signals to various monitors, displays, projectors, and/or speakers simply by pressing front panel pushbuttons. The VM3200 / VM3250's built-in Scaler encodes video formats in order to provide seamless, real-time switching while ensuring stable signal transmission. In addition, the front panel LCD shows a quick view of active port connections, and includes an option to select an EDID Mode that yields the best resolution across different monitors.

The VM3200 / VM3250 is easily expandable and accommodates ATEN's hot-swappable I/O boards. Equipped with automatic signal conversion, it allows a combination of digital video formats, thus making it ideal for large-scale AV applications.

Setup is fast and easy; install the modular I/O boards by sliding them into the VM3200 / VM3250's rear panel slots, then plug the device cables into the appropriate ports on the I/O boards and you're ready.

This solution can be connected to the network through the VM3200 / VM3250's LAN port, allowing the installation to take advantage of internal Cat 5 Ethernet wiring built into most modern commercial buildings. Once initial network setup has been accomplished at the local level, the VM3200 / VM3250 can be conveniently managed remotely using any web browser and a

free app, the ATEN Video Matrix Control App. For more information, see *Video Matrix Control App User Manual*.

Furthermore, for complete systems integration, the VM3200 / VM3250's built-in RS-232 and RS-485/RS-422 ports allows the switch to be configured through a high-end controller or PC.

The ATEN Modular Matrix Solution Series is a powerful integrated AV setup targeted towards broadcasting stations, traffic and transportation-related control rooms, emergency service centers and any application that requires customizable high speed AV signal routing.

## Features

---

### **VM3200 / VM3250**

- ◆ AV matrix switching – routes any of the 32 input devices to any of the 32 output devices via 8 x 8 I/O slots
- ◆ Multiple control methods – including front-panel pushbuttons, RS-232/422/485 control, and Ethernet connections for web GUI or Telnet
- ◆ 4K resolutions – the VM3200 supports up to UHD (3840 x 2160) and DCI (4096 x 2160) with refresh rates of 30 Hz (4:4:4) and 60 Hz (4:2:0)\*
- ◆ True 4K resolutions – the VM3250 supports uncompressed video resolutions up to 4096 x 2160 / 3840 x 2160@60Hz (4:4:4)\*
- ◆ Seamless Switch™ – features close-to-zero second switching for continuous video streams, real-time switching, and stable signal transmissions\*
- ◆ Scaler – features a video scaling function to convert input resolutions to the optimum display resolutions\*
- ◆ Video wall – allows you to create custom video wall layouts via intuitive web GUI\*
- ◆ Live stream of connected video channels and image preview of video wall layouts via web GUI
- ◆ Livestreaming of a source video to a streaming media (VM3250 only)
- ◆ Profile scheduling – plays connection profiles based on user-defined schedules
- ◆ Livestreaming of a connected video source via the Web GUI
- ◆ Supports free mobile control using the Video Matrix Control App
- ◆ EDID Expert™ – selects optimum EDID settings for smooth power-up, high-quality display and use of the best resolution across different screens
- ◆ Audio-enabled – HDMI audio can be extracted and stereo audio can be embedded\*
- ◆ Bi-directional RS-232 channel – allows you to control connected serial devices through the web GUI
- ◆ Supports redundant power module for higher reliability
- ◆ Hot-pluggable design for easy integration of I/O boards, fan module, and power supplies
- ◆ HDCP 2.2 Compatible\*
- ◆ HDMI: 3D, Deep Color, 4K\*
- ◆ Consumer Electronics Control (CEC) supported\*

- ◆ Rack mountable (9U design)
  - ◆ ESD protection for HDMI
- 

**Note:**

- ◆ Features marked with an asterisk (\*) are supported only with specific I/O boards. For more information, see the feature descriptions for I/O boards in this manual.
  - ◆ The maximal output resolution, and the Scaler, Seamless Switch™ and video wall features are only supported with certain I/O boards. For more details, refer to the specifications of the particular I/O boards.
  - ◆ When Seamless Switch™ or Video Wall is enabled, videos may not display within range, in which case make sure to adjust the display settings on your device.
  - ◆ Video outputs will not display 3D, Deep Color, or interlace (i.e., 1080i) resolutions correctly if Seamless Switch™ is enabled. To use these features, make sure to first disable Seamless Switch™.
  - ◆ For more information on the Video Matrix Control app, see *Video Matrix Control App User Manual*.
-



**VM7584 / VM8584**

- ◆ Compatible with the VM3200 / VM3250; mix and match with modular output boards of any type for optimum flexibility
- ◆ Extends audio, video, IR, and RS-232 control signals over long distances via duplex fiber optic cables
- ◆ Superior video quality (up to 4096 x 2160@60Hz 4:2:0) over long distances:
  - ◆ 300 m with VM7584K1 / VM8584K1 over multimode cables
  - ◆ 10km with VM7584K2 / VM8584K2 over single-mode cables
- ◆ Scaler – features a 4K video scaling function to convert input resolutions to the optimum display resolutions (VM8584 only)
- ◆ Seamless Switch™ – features close-to-zero-second switching to provide continuous video streams, real-time switching, and stable signal transmissions (VM8584 only)
- ◆ Video wall – allows you to create custom video wall layouts via intuitive web GUI (VM8584 only)
- ◆ HDMI (3D, Deep Color, 4K); HDCP 2.2 compatible
- ◆ Consumer Electronics Control (CEC) support
- ◆ Bi-directional RS-232 channel – allows you to connect to serial terminals or serial devices, such as touch screens and barcode scanners
- ◆ Bi-directional IR channel – IR transmission is processed one direction at a time, ranging from 30 kHz to 60 kHz
- ◆ EDID Expert™ – selects optimum EDID settings for smooth power-up, high-quality display, and best resolutions across different screens
- ◆ FrameSync – prevents image tearing by synchronizing the scaler output frame rate to the input signal frame rate (VM8584 only)
- ◆ Hot-swappable fiber optic module and input board for easy integration and maintenance.

---

**Note:** The VM7584 / VM8584 is designed to work with the VE883 video extender.

---

## **VM7514 / VM8514**

- ◆ Compatible with the VM3200 / VM3250; mix and match with modular I/O boards of any type for optimum flexibility
- ◆ Superior video quality up to 4K when used with VE816R
- ◆ Long-distance transmission up to 100 m
- ◆ Bi-directional RS-232 channel transmits signals over Cat 6/6a cable to control a display or other devices
- ◆ HDBaseT Connectivity – extends 4 HDBaseT connections over a long distance via a single Cat 6/6a cable or ATEN 2L-2910 Cat 6 cable
- ◆ HDBaseT Anti-jamming – resists signal interference during high-quality video transmissions using HDBaseT technology
- ◆ Seamless Switch™ – features close-to-zero second switching that provides continuous video streams, real-time switching, and stable signal transmissions (VM8514 only)\*
- ◆ Video wall – allows you to create custom video wall layouts via intuitive web GUI (VM8514 only)\*
- ◆ Bi-directional IR channel – full range IR transmission (30 ~ 56 kHz) is processed one direction at a time

---

### **Note:**

- ◆ The Seamless Switch™ and video wall functions are only available when used with the VE805R and VE816R.
  - ◆ When Seamless Switch™ or Video Wall is enabled, videos may not display within range, in which case make sure to adjust the display settings on your device.
  - ◆ Video outputs will not display 3D, Deep Color, or interlace (i.e., 1080i) resolutions correctly if Seamless Switch™ is enabled. To use these features, make sure to first disable Seamless Switch™.
-

## **VM7904**

- ◆ Compatible with the VM3200 / VM3250; mix and match with modular I/O boards of any type for optimum flexibility
- ◆ Connects up to 4 DisplayPort inputs to up to 32 displays
- ◆ Superior video quality – up to 4096 x 2160 / 3840 x 2160 @ 30 Hz (4:4:4)
- ◆ Audio-enabled - stereo audio can be routed independently or embedded for HDMI output
- ◆ EDID Expert™ – selects optimum EDID settings for smooth power-up and highest quality display
- ◆ Support DP1.1 with data rate up to 10.8 Gbps (2.7 Gbps per lane)
- ◆ HDCP 2.2 Compliant
- ◆ Hot-swappable design for easy integration and maintenance

---

**Note:** When the VM7904 is used with the VM8514+VE805R/VE816R, VM8804, VM8814, or VM8604, the Seamless Switch™, scaler, and video wall functions can be activated.

---

**VM7824 / VM8824**

- ◆ Compatible with the VM3200 / VM3250; mix and match with modular I/O boards of any type for optimum flexibility
- ◆ Superior video quality:
  - ◆ For VM3200: HDTV resolutions of 480p, 720p, 1080i, and 1080p (1920 x 1080); 4K2K @ 60Hz (4:2:0)
  - ◆ For VM3250: HDTV resolutions of 480p, 720p, 1080i, and 1080p (1920 x 1080); 4K2K @ 60Hz (4:4:4)
- ◆ Audio-enabled, HDMI audio can be extracted and stereo audio can be embedded
- ◆ Scaler – features a 4K video scaling function to convert input resolutions to the optimum display resolutions\* (VM8824 only)
- ◆ Seamless Switch™ – features close-to-zero-second switching to provide continuous video streams, real-time switching, and stable signal transmissions\* (VM8824 only)
- ◆ Video Wall – allows you to create custom video wall layouts via intuitive web GUI (VM8824 only)
- ◆ HDMI (3D, Deep Color)\*; HDCP 2.2 Compatible
- ◆ Cable Quality Tester – examines the HDMI cable quality
- ◆ Consumer Electronics Control (CEC) support
- ◆ EDID Expert™ – selects optimum EDID settings for smooth power-up and highest quality display
- ◆ FrameSync – prevents image tearing by synchronizing the scaler output frame rate to the input signal frame rate (VM8824 only)

---

**Note:**

- ◆ The VM7824 / VM8824 will support resolutions up to 4K when installed on the VM3200.
  - ◆ When Seamless Switch™ or Video Wall is enabled, videos may not display within range, in which case make sure to adjust the display settings on your device.
  - ◆ When Seamless Switch™ is enabled, video outputs will not display 3D, Deep Color, or interlace (i.e., 1080i) resolutions correctly.
-

**VM7814 / VM8814**

- ◆ Compatible with the VM3200 / VM3250; mix and match with modular I/O boards of any type for optimum flexibility
- ◆ Superior video quality – HDTV resolutions of 480p, 720p, 1080i, and 1080p (1920 x 1080); 4K2K @ 60Hz (4:2:0)
- ◆ Audio-enabled, HDMI audio can be extracted and stereo audio can be embedded
- ◆ Scaler – features a 4K video scaling function to convert input resolutions to the optimum display resolutions\* (VM8814 only)
- ◆ Seamless Switch™ – features close-to-zero-second switching to provide continuous video streams, real-time switching, and stable signal transmissions\* (VM8814 only)
- ◆ Video Wall – allows you to create custom video wall layouts via intuitive web GUI (VM8814 only)
- ◆ HDMI (3D, Deep Color)\*; HDCP 2.2 Compatible
- ◆ Cable Quality Tester – examines the HDMI cable quality
- ◆ Consumer Electronics Control (CEC) support
- ◆ EDID Expert™ – selects optimum EDID settings for smooth power-up and highest quality display
- ◆ FrameSync – prevents image tearing by synchronizing the scaler output frame rate to the input signal frame rate (VM8814 only)

---

**Note:**

- ◆ When Seamless Switch™ or Video Wall is enabled, videos may not display within range, in which case make sure to adjust the display settings on your device.
  - ◆ When Seamless Switch™ is enabled, video outputs will not display 3D, Deep Color, or interlace (i.e., 1080i) resolutions correctly.
-

## **VM7804 / VM8804**

- ◆ Compatible with the VM3200 / VM3250; mix and match with modular I/O boards of any type for optimum flexibility
- ◆ Superior video quality – HDTV resolutions of 480p, 720p, 1080i (1920 x 1080), and 1080p (1920 x 1080)
- ◆ Audio-enabled, HDMI audio can be extracted and stereo audio can be embedded
- ◆ Scaler – features a video scaling function to convert input resolutions to the optimum display resolutions\* (VM8804 only)
- ◆ Seamless Switch™ – features close-to-zero-second switching to provide continuous video streams, real-time switching, and stable signal transmissions\* (VM8804 only)
- ◆ Video Wall – allows you to create custom video wall layouts via intuitive web GUI (VM8804 only)
- ◆ HDMI (3D, Deep Color); HDCP 1.4 Compatible
- ◆ Consumer Electronics Control (CEC) support
- ◆ EDID Expert™ – selects optimum EDID settings for smooth power-up and highest quality display

---

### **Note:**

- ◆ When Seamless Switch™ or Video Wall is enabled, videos may not display within range, in which case make sure to adjust the display settings on your device.
  - ◆ When Seamless Switch™ is enabled, video outputs will not display 3D, Deep Color, or interlace (i.e., 1080i) resolutions correctly. To use these features, make sure to first disable Seamless Switch™.
-

**VM7604 / VM8604**

- ◆ Compatible with the VM3200 / VM3250; mix and match with modular I/O boards of any type for optimum flexibility
- ◆ 4 DVI-D input ports (VM7604); 4 DVI-D output ports (VM8604)
- ◆ Scaler – features a video scaling function to convert input resolutions to the optimum display resolutions\* (VM8604 only)
- ◆ Seamless Switch™ – features close-to-zero-second switching to provide continuous video streams, real-time switching, and stable signal transmissions\* (VM8604 only)
- ◆ Video Wall – allows you to create custom video wall layouts via intuitive web GUI (VM8604 only)
- ◆ HDCP 1.4 Compatible
- ◆ EDID Expert™ – selects optimum EDID settings for smooth power-up and highest quality display
- ◆ Built-in EDID wizard – provides an easy way to customized EDID settings
- ◆ Audio-enabled, HDMI audio (VM7804 / VM7814 / VM7824) can be extracted to VM8604; VM7604's stereo audio can be embedded to HDMI audio (VM8804 / VM8814 / VM8824)

---

**Note:**

- ◆ When Seamless Switch™ or Video Wall is enabled, videos may not display within range, in which case make sure to adjust the display settings on your device.
  - ◆ When Seamless Switch™ is enabled, video outputs will not display 3D, Deep Color, or interlace (i.e., 1080i) resolutions correctly. To use these features, make sure to first disable Seamless Switch™.
-

## **VM7104**

- ◆ Compatible with the VM3200 / VM3250; mix and match with modular I/O boards of any type for optimum flexibility
- ◆ Connects up to 4 VGA or Component inputs
- ◆ Supports RGBHV / RGBS / YPbPr / YCbCr input signals
- ◆ Audio-enabled, stereo audio can be embedded into HDMI audio (VM8804 / VM8814 / VM8824)

---

**Note:** When the VM7104 is used with the VM8514+VE805R/VE816R, VM8804, VM8814, VM8824 or VM8604, the Seamless Switch™, scaler, and video wall functions can be activated.

---

## **VM7404**

- ◆ Connects up to 4 SDI inputs
- ◆ Compatible with the VM3200 / VM3250; mix and match with modular I/O boards of any type for optimum flexibility
- ◆ Support SD-SDI, HD-SDI, and 3G-SDI formats
- ◆ Audio-enabled, stereo audio can be embedded into HDMI audio (VM8804 / VM8814 / VM8824)

---

**Note:** When the VM7404 is used with the VM8514+VE805R/VE816R, VM8804, VM8814, VM8824 or VM8604, the Seamless Switch™, scaler, and video wall functions can be activated.

---



**VE805R**

- ◆ Extends HDMI, RS-232, and IR signals up to 70 m over a single Cat 5e/6/6a cable
- ◆ HDMI (3D, Deep Color); HDCP 1.4 compliant
- ◆ Superior video quality – 1080p@60m (Cat 5e/6); 70m (Cat 6a)
- ◆ Scaler – scales videos of different resolutions to their optimal output for display and to avoid black screen\*
- ◆ Video Wall – features video wall profiles that allows for custom screen layouts via an intuitive web GUI\*
- ◆ Seamless Switch™ – close-to-zero second switching that provides continuous video streams, real-time switching, and stable signal transmissions\*
- ◆ HDBaseT Anti-jamming – resists signal interference during high-quality video transmissions using HDBaseT technology
- ◆ Bi-directional RS-232 channel – allows for control using serial terminals or serial devices, such as touch screens and barcode scanners
- ◆ Bi-directional IR channel – IR transmission is processed one direction at a time\*
- ◆ Firmware upgradeable
- ◆ Built-in 8KV / 15 KV ESD protection
- ◆ Plug-and-play
- ◆ Rack-mountable

---

**Note:**

- ◆ The Seamless Switch™ and the video wall functions are only available when the VE805R is used with the ATEN HDBaseT I/O boards.
  - ◆ When Seamless Switch™ or Video Wall is enabled, videos may not display within range, in which case make sure to adjust the display settings on your device.
  - ◆ When Seamless Switch™ is enabled, video outputs will not display 3D, Deep Color, or interlace (i.e., 1080i) resolutions correctly. To use these features, make sure to first disable Seamless Switch™.
  - ◆ The VE805R supports full-frequency IR signals from 30 kHz to 56 kHz.
-

## **VE816R**

- ◆ Extends HDMI, RS-232, and IR signals up to 100 m over a single Cat 5e/6/6a or ATEN 2L-2910 Cat 6 cable
- ◆ HDCP 2.2 compatible
- ◆ Superior video quality (4K up to 100m; 1080p up to 150m)
- ◆ HDBaseT Long Reach Mode – activated by RS-232 commands, Long Reach Mode extends signals up to 150 m, 1080p, via a single Cat 5e/6 cable
- ◆ Scaler – scales videos of different resolutions to their optimal output for display and to avoid black screen
- ◆ Video Wall – features video wall profiles that allows for custom screen layouts via an intuitive web GUI\*
- ◆ Seamless Switch™ – close-to-zero second switching that provides continuous video streams, real-time switching, and stable signal transmissions\*
- ◆ HDBaseT Anti-jamming – resists signal interference during high-quality video transmissions using HDBaseT technology
- ◆ Bi-directional RS-232 channel – allows for control using serial terminals or serial devices, such as touch screens and barcode scanners
- ◆ Bi-directional IR channel – IR transmission is processed one direction at a time\*
- ◆ Cable Quality Tester – examines the category cable quality through signal level detection from HDBaseT Matrix Switches to the VE816R.
- ◆ FrameSync – prevents image tearing by synchronizing the scaler output frame rate to the input signal frame rate
- ◆ Remote Firmware upgrade
- ◆ Built- in 8KV / 15 KV ESD protection
- ◆ Plug-and-play
- ◆ Rack-mountable

---

### **Note:**

- ◆ The Seamless Switch™ and the video wall functions are only available when the VE816R is used with ATEN HDBaseT I/O boards.
  - ◆ When Seamless Switch™ or Video Wall is enabled, videos may not display within range, in which case make sure to adjust the display settings on your device.
  - ◆ When Seamless Switch™ is enabled, video outputs will not display 3D, Deep Color, or interlace (i.e., 1080i) resolutions correctly. To use these features, make sure to first disable Seamless Switch™.
  - ◆ The VE816R supports full-frequency IR signals from 30 kHz to 56 kHz.
-

## Requirements

---

The following are required for a complete VM3200 / VM3250 Modular Matrix Solution Series installation:

### **Input / Output Board**

- ◆ VM7584 (4-Port 10G Optic Input Board) and VM8584 (4-Port 10G Optic Output Board)
- ◆ VM7514 (HDBaseT input board) and VM8514 (HDBaseT output board)
- ◆ VM7904 (4-Port 4K DisplayPort Input Board)
- ◆ VM7824 (True 4K HDMI input board) and VM8824 (True 4K HDMI output board)

---

**Note:** The VM7824 and VM8824 can only support true 4K videos when installed on VM3250.

---

- ◆ VM7814 (4K HDMI input board) and VM8814 (4K HDMI output board)

---

**Note:** The VM7814 and VM8814 are only supported on the VM3200 using firmware version 1.1.107 or later.

---

- ◆ VM7804 (HDMI input board) and VM8804 (HDMI output board)
- ◆ VM7604 (DVI input board) and VM8604 (DVI output board)
- ◆ VM7104 (VGA input board)
- ◆ VM7404 (3G-SDI input board)

### **Source Devices**

- ◆ For VM7584 4-Port 10G Optic Input Board + VE883T HDMI Optical Transmitter: Digital AV source devices with HDMI output connector(s)
- ◆ For VM7514 4-port HDBaseT input board + VE802T HDBaseT Transmitter: Digital AV source device with HDMI output connector(s)
- ◆ For VM7904 4-Port 4K DisplayPort Input Board: Digital AV source device with DisplayPort output connector(s)
- ◆ For VM7824 4-port True 4K HDMI input board: Digital AV source device with HDMI output connector(s)
- ◆ For VM7814 4-port 4K HDMI input board: Digital AV source device with HDMI output connector(s)
- ◆ For VM7804 4-port HDMI input board: Digital AV source device with HDMI output connector(s)
- ◆ For VM7604 4-Port DVI input board: Digital AV source device with DVI output connector(s)

- ◆ For VM7104 4-Port VGA input board: AV source device with VGA output connector(s)
- ◆ For VM7404 4-Port 3G-SDI Input Board: SDI sources, including 3G-SDI, HD-SDI and SD-SDI

## **Display Devices**

- ◆ For VM8584 4-Port 10G Optic Input Board + VE883R HDMI Optical Receiver: Digital AV display devices with HDMI output connector(s)
- ◆ For VM8514 4-port HDBaseT output board + VE805R HDBaseT Receiver / VE816R 4K HDMI HDBaseT Receiver: Digital Display device(s) with HDMI input connector(s)

---

**Note:** The VE816R is only supported by the VM8514 using firmware version 2.1.206 or later.

---

- ◆ For VM8824 4-port True 4K HDMI output board: Digital Display device(s) with HDMI input connector(s)
- ◆ For VM8814 4-port 4K HDMI output board: Digital Display device(s) with HDMI input connector(s)
- ◆ For VM8804 4-port HDMI output board: Digital Display device(s) with HDMI input connector(s)
- ◆ For VM8604 4-Port DVI output board: Digital Display device(s) with DVI input connector(s)

## **Cables**

- ◆ 1 duplex fiber optic cable for each transmitter (VM7584)
- ◆ 1 duplex fiber optic cable for each receiver (VM8584)
- ◆ 1 SDI cable for each source device (VM7404)
- ◆ 1 Cat 5e cable for each transmitter (VM7514)
- ◆ 1 Cat 5e cable for each receiver (VM8514)
- ◆ 1 DisplayPort cable for each source device (VM7904)
- ◆ 1 HDMI cable for each source device (VM7824 / VM7814 / VM7804)
- ◆ 1 HDMI cable for each display device (VM8824 / VM8814 / VM8804)
- ◆ 1 DVI cable for each source device (VM7604)
- ◆ 1 DVI cable for each display device (VM8604)
- ◆ 1 VGA cable for each source device (VM7104)
- ◆ 1 HDMI cable for each display device (VE805R / VE816R)

- ◆ 1 audio cable for each audio source device (VM7824 / VM7814 / VM7804 / VM7604)
- ◆ 1 audio cable for each audio device / speaker (VM8824 / VM8814 / VM8804 / VM8604)
- ◆ 1 Ethernet cable (VM3200 / VM3250)
- ◆ 1 RS-232 serial cable (VM3200 / VM3250 / VM7514 / VM8514 / VE805R / VE816R)
- ◆ 1 RS-485/RS-422 serial cable (VM3200 / VM3250)
- ◆ 1 IR cable for each IR transmitter device (VM7514 or VM8514)
- ◆ 1 IR cable for each IR receiver device (VM7514 or VM8514)

---

**Note:** No cables are included in this package. We strongly recommend that you purchase high-quality cables of appropriate length since this will affect the quality of the audio and video display. Contact your dealer to purchase the correct cable sets.

---

## **Compatible Browsers**

In order to achieve the best performance, the browsers listed in the table below are recommended to be used with the VM3200 / VM3250's GUI.

OS	Java Version	Browser	Version
Windows 10 (64 bit)	V1.8.0_181 (64 bit)	Chrome	69.0.3497.71 x64
		Edge	40.15063.674.0
		Firefox	62.0x64
Windows 8.1	V1.8.0_181	IE	11
Windows 2016 x64	V1.8.0_181 (64 bit)	IE	11 x64
Windows 2012 R2 x64	V1.8.0_181 (64 bit)	IE	11 x64
Windows 10 x64	V1.8.0_181 (64 bit)	QQ	10.2.1
MAC 10.10	V1.8.0_25	Safari	8

## **Optional Equipment**

Purchase optional equipment such as a secondary power module, fan, or rack mount kit to get the most out of your ATEN Modular Matrix. For more information, go to <https://www.aten.com/global/en/>

# Components

## VM3200 / VM3250 Front View

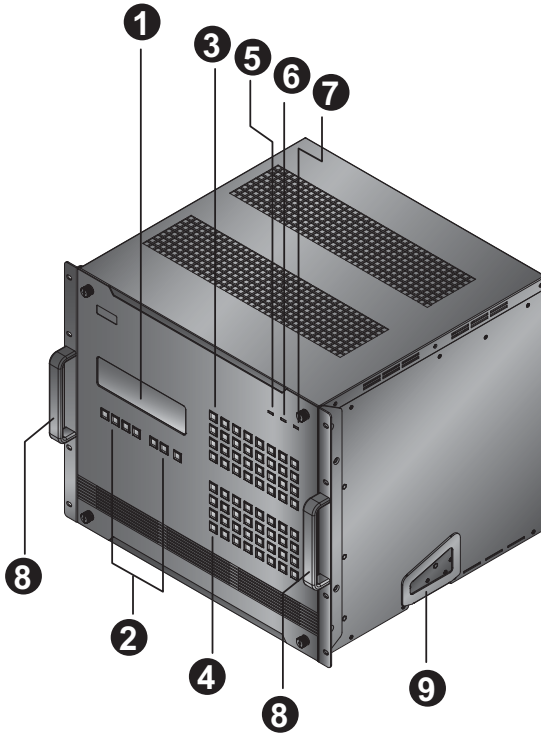

No.	Component	Description
1	LCD display	The LCD display shows the options for configuring and operating the VM3200 / VM3250. See <i>Front Panel Pushbuttons</i> , page 43, for details.
2	function pushbuttons	Use the UP, DOWN and CANCEL buttons to navigate the LCD display to configure the installation. Press the Video, Audio, Menu and Profile buttons to use each function. See <i>Front Panel Pushbuttons</i> , page 43, for details. <b>Note:</b> The pushbuttons have LEDs that light to indicate they have been selected.
3	input pushbuttons (1-32)	These pushbuttons refer to the input ports on the VM3200 / VM3250 rear panel. Press to select the input port. These pushbuttons may also correspond to menu options, profiles and other selections.

---

No.	Component	Description
4	output pushbuttons (1-32)	These pushbuttons refer to the output ports on the VM3200 / VM3250 rear panel. Press to select the output port.
5	alarm LED	The alarm LED lights red to indicate the power or fan module has failed.
6	redundant power LED	This LED lights green to indicate the redundant power module is plugged in and working.
7	primary power LED	This LED lights green to indicate the primary power module is plugged in and working.
8	handles	The two front handles are used to install the unit into a rack.
9	recessed handles	The two side handles are used to transport the unit. Push in to lock and unlock the handles so that they can be used to carry the unit and be tucked away when not in use.

---

## VM3200 / VM3250 Rear View

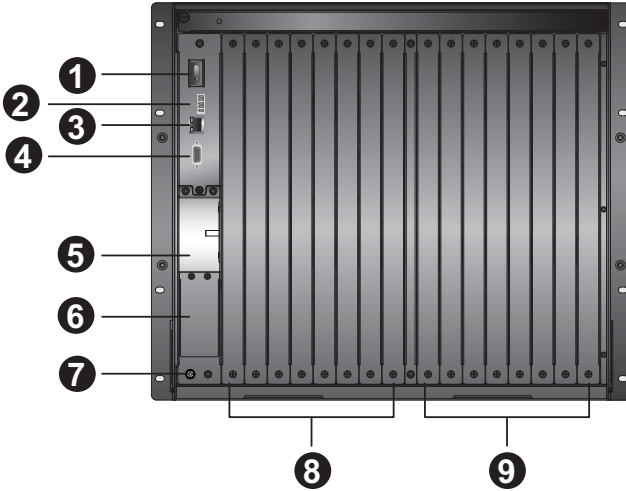

No.	Component	Description
1	power switch	This is a standard rocker switch that powers the unit on and off.
2	RS-485 / RS-422 serial port	Connect a computer or high-end system controller via this serial port.
3	Ethernet port	In order to access the VM3200 / VM3250's web Graphical User Interface (GUI), the VM3200 / VM3250 must be connected to the network. The cable that connects the VM3200 / VM3250 to your LAN plugs in here. For further details, see <i>Installation</i> page 37.
4	RS-232 serial port	Connect a computer or high-end system controller via this serial port.
5	primary power slot	This is a standard 3-pin power socket. The power cord from a source plugs in here.
6	redundant power slot	This slot with protective cover is used to install an additional power supply for redundant power protection. For more information about the power module, visit the product web page..



No.	Component	Description
7	grounding terminal	The grounding wire attaches here. See <i>Installation</i> page 37, for further details.
8	output board slots	Unscrew the cover to insert the output boards into these 8 vertical slots. The display devices connect to the inserted output boards.
9	input board slots	Unscrew the cover to insert the Input boards into these 8 vertical slots. The source devices connect to the inserted input boards.

## Power Module

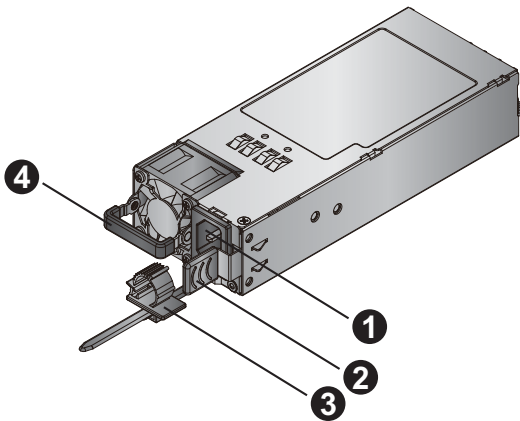

No.	Component	Description
1	3-prong socket	Receives a power cord which connects to a power source at the other end.
2	power module release lever	Press this lever to unlock the power module and remove it from the VM3200 / VM3250 device.
3	cable strap	Optionally use this strap to hold the power cable in place.
4	power module handle	Use the handle with the release lever to remove the power module from the VM3200 / VM3250 device.

## VM7584 Front View

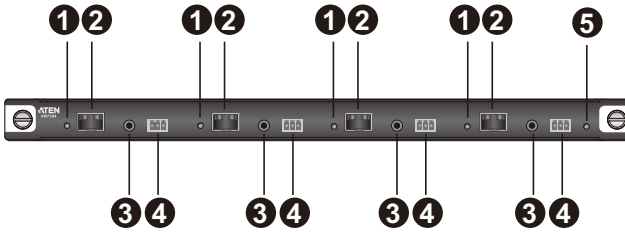

No.	Component	Description
1	link LEDs	Light up to indicate stable connection with the connected source devices.
2	SFP+ ports	Connect up to four VE883T units via SFP+ modules to receive data from input devices.
3	IR ports	Connect to the supplied IR receiver or IR emitter to bypass IR signals via the VM7584. To operate from the VM7584's side, plug in the IR receiver to the VM7584, and the IR emitter to the output board that you wish to bypass the IR signals.
4	RS-232 channel ports	Connect to a serial controller to bypass RS-232 serial signals.
5	status LED	Indicates the working status of the unit.

## VM8584 Front View

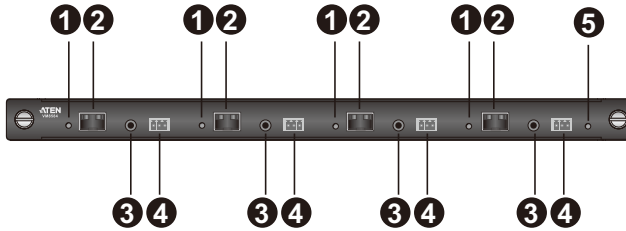

No.	Component	Description
1	link LEDs	Light up to indicate stable connection with the connected source devices.
2	SFP+ ports	Connect up to four VE883R units via SFP+ modules to transmit data to output devices.
3	IR ports	Connect to the supplied IR receiver or IR emitter to bypass IR signals via the VM8584. To operate from the VM8584's side, plug in the IR receiver to the VM8584, and the IR emitter to the input board that you wish to bypass the IR signals.
4	RS-232 channel ports	Connect to a serial controller to bypass RS-232 serial signals.
5	status LED	Indicates the working status of the unit.

## **VM7514 Front View**

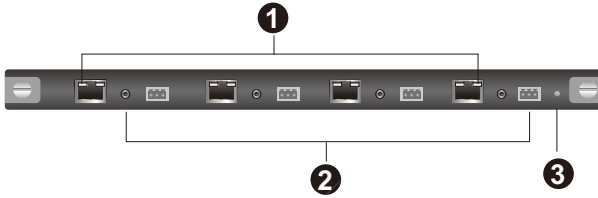

No.	Component	Description
1	HDBaseT input ports	Connect the Cat 5e cables from your HDBaseT transmitter to these ports.
2	IR / RS-232 input ports	Connect the cables from your IR transmitter to the mini stereo jack ports, and connect the cables from your RS-232 device to the RS-232 ports.
3	status LED	Indicates the working status of the unit.

## **VM8514 Front View**

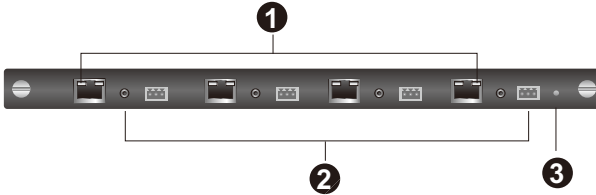

No.	Component	Description
1	HDBaseT output ports	Connect the Cat 5e cables from your HDBaseT receiver to these ports.
2	IR / RS-232 output ports	Connect the cables from your IR receiver to the mini stereo jack ports, and connect the cables from your RS-232 device to the RS-232 ports.
3	status LED	Indicates the working status of the unit.

## VM7904 Front View

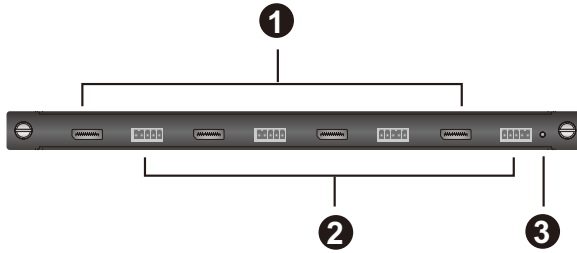

No.	Component	Description
1	DisplayPort input ports	Connect the cables from your DisplayPort video source devices to these ports.
2	audio input ports	Connect the cables from your audio source devices to these ports.
3	status LED	Indicates the working status of the unit.

## VM7824 Front View

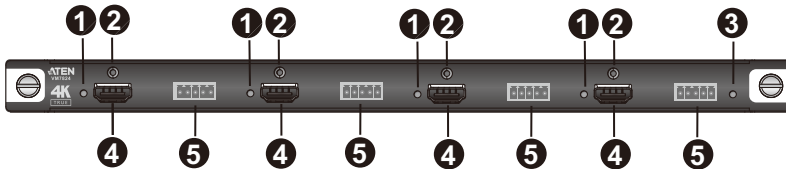

No.	Component	Description
1	link LEDs	Lights up to indicate stable connection with the connected source devices.
2	ATEN LockPro™ screws	Optionally secure an ATEN LockPro™ to hold the HDMI cable in place and prevent it from falling off.
3	status LED	Indicates the working status of the unit.
4	HDMI input ports	Connect to HDMI source devices via HDMI cables.
5	Audio input ports	Connect to audio source devices that you wish to embed via audio cables.

## VM8824 Front View

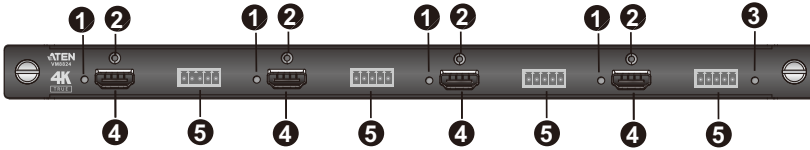

No.	Component	Description
1	link LEDs	Lights up to indicate stable connection with the connected display devices.
2	ATEN LockPro™ screws	Optionally secure an ATEN LockPro™ to hold a the HDMI cable in place and prevent it from falling off.
3	status LED	Indicates the working status of the unit.
4	HDMI output ports	Connect to HDMI-enabled displays via HDMI cables.
5	audio output ports	Connect to speakers or audio output devices that you via audio cables.

## VM7814/VM7804 Front View

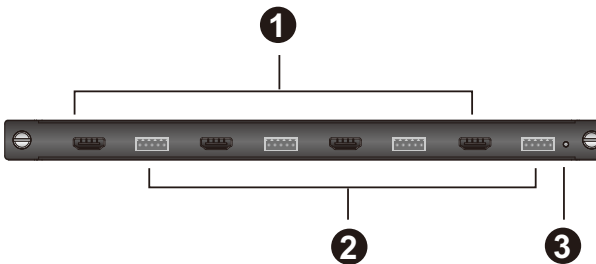

No.	Component	Description
1	HDMI input ports	Connect the cables from your HDMI video source devices to these ports.
2	audio input ports	Connect the cables from your audio source devices to these ports.
3	status LED	Indicates the working status of the unit.

## VM8814/VM8804 Front View

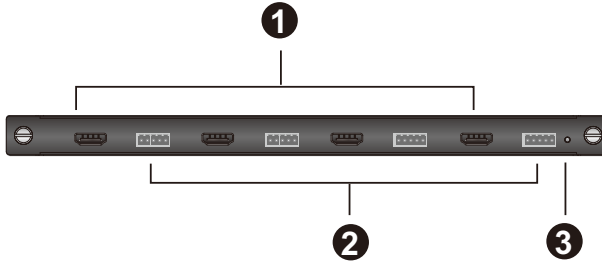

No.	Component	Description
1	HDMI output ports	Connect the cables from your HDMI display devices (monitors, projectors, TVs) to these ports.
2	audio output ports	Connect the cables from your output audio devices or speakers to these ports.
3	status LED	Indicates the working status of the unit.

## VM7604 Front View

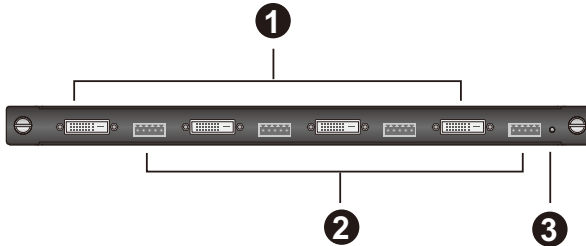

No.	Component	Description
1	DVI input ports	Connect the cables from your video source devices to these ports.
2	audio input ports	Connect the cables from your audio source devices to these ports.
3	status LED	Indicates the working status of the unit.

## VM8604 Front View

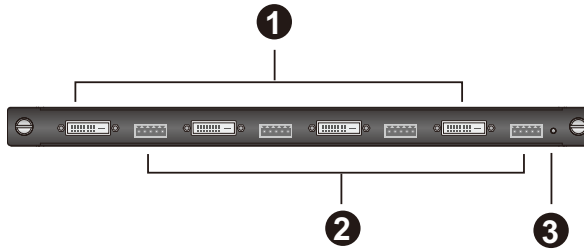

No.	Component	Description
1	DVI output ports	Connect the cables from display devices (monitors, projectors, TVs) to these ports.
2	audio output ports	Connect the cables from your output audio devices or speakers to these ports.
3	status LED	Indicates the working status of the unit.

## VM7104 Front View

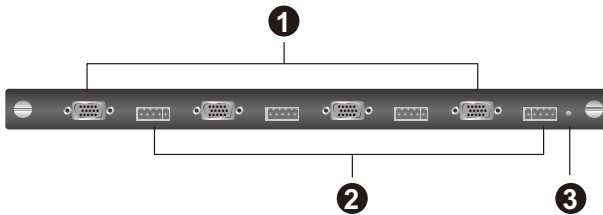

No.	Component	Description
1	VGA input ports	Connect the cables from your VGA video source devices to these ports.
2	audio input ports	Connect the cables from your audio source devices to these ports.
3	status LED	Indicates the working status of the unit.



## VM7404 Front View

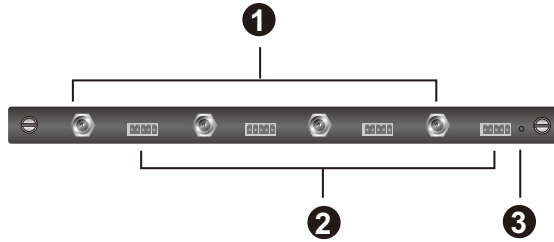

No.	Component	Description
1	SDI input ports	Connect the cables from your video source devices to these ports.
2	analog stereo audio input ports	Connect the cables from your audio source devices to these ports.
3	status LED	The VM7404 has an LED to indicate the working status.

## VE805R / VE816R Front View

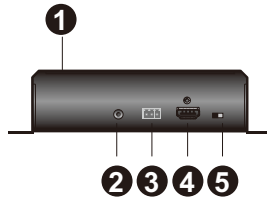

## VE805R / VE816R Rear View

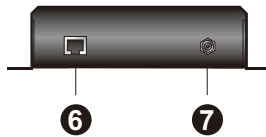

No.	Component	Description
1	LEDs	<p>Three LEDs – power, link and HDMI out – light when the unit is properly connected to an appropriate source.</p> <ul style="list-style-type: none"> <li>◆ Power - lights Green to indicate the unit is receiving power.</li> <li>◆ Link - lights Orange to indicate that communication between VE805R / VE816R and output board is established.</li> <li>◆ HDMI out - lights Orange to indicate the HDMI output signal is good. LED blinks Orange every second to indicate that the device is in F/W upgrade mode.</li> </ul>
2	IR port	Connect the IR transmitter or receiver cable port into this mini stereo jack port.
3	RS-232 port	Use the captive screw connectors (3 pole) to connect the cable from your serial device into the RS-232 port.
4	HDMI output port	Connect the cable from your HDMI display device (monitors, projectors, TVs) into this port.
5	firmware upgrade switch	Set this switch to OFF (left) for normal operation. Set this switch to ON (right) and reset the unit's power to enter firmware upgrade mode.
6	HDBaseT input	Use a Cat 5e cable to connect the VE805R / VE816R to the VM8514 output board.
7	power jack	The power adapter cable plugs connects here.

## Chapter 2

# Hardware Setup



1. Important safety information regarding the placement of this device is provided on page 177. Please review it before proceeding.
2. Make sure that the power to all devices connected to the installation are turned off. You must unplug the power cords of any computers that have the Keyboard Power On function.

### Transporting and Storing the Unit

---

Its important to properly transport and store the VM3200 / VM3250. Follow the instructions below to avoid damaging the VM3200 / VM3250 due to improper handling.

When not rack mounted, the VM3200 / VM3250 should be placed on a flat and level surface with the bottom side down. The unit should never be placed with the front, rear or sides facing the ground.

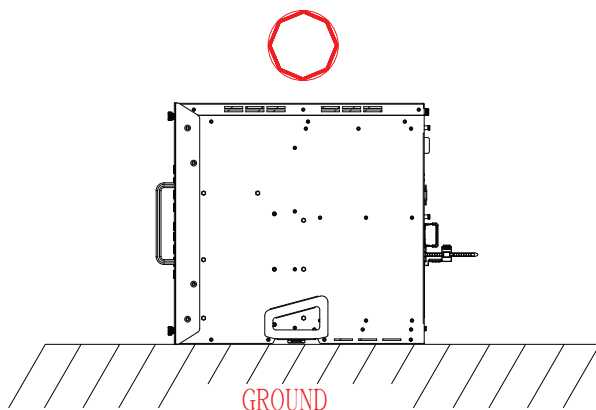

## Rack Mounting

---

The Modular Matrix Switch can be mounted in a 19" (1U) system rack. For the most convenient front panel operation at the local site, mount the unit at the front of the rack, as follows:

1. Position the unit in the front of the rack, and align the holes of the unit's built-in mounting brackets with the holes in the rack.
2. Use screws to attach the unit to the rack.

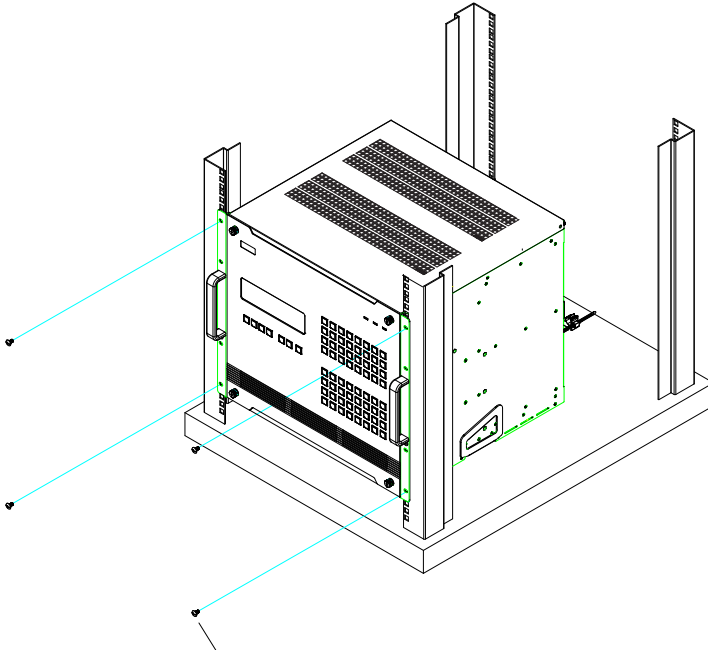

---

### Note:

- ◆ Please allow 1U (44 mm) of space between the top of the VM3200 / VM3250 and any object to prevent obstruct of the air flow.
  - ◆ To ensure the VM3200 / VM3250 has sufficient air flow, do not stack items on top or in front of the unit. Proper air flow ensures safe operation and prevents the unit from overheating.
-

## Mounting with Brackets

You can also use mounting brackets to install the VM3200 / VM3250, as shown below.

---

**Note:** The Easy Installation Mounting Kit is not included with the package (see page 19). To purchase a mounting kit please contact your dealer.

---

1. Screw the mounting brackets to the rack, as shown in the diagram.

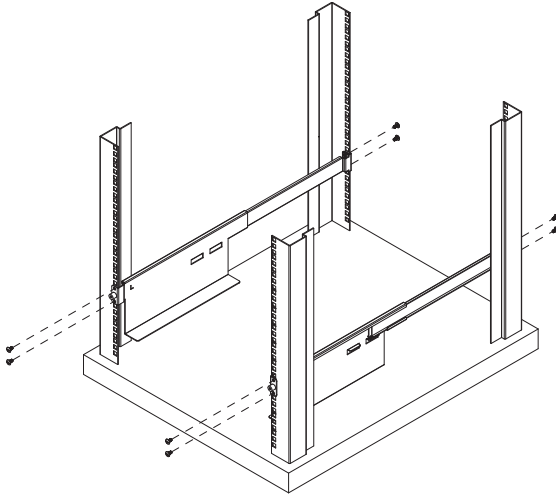

2. Push in and lock the recessed handles, and then slide the unit along the brackets.

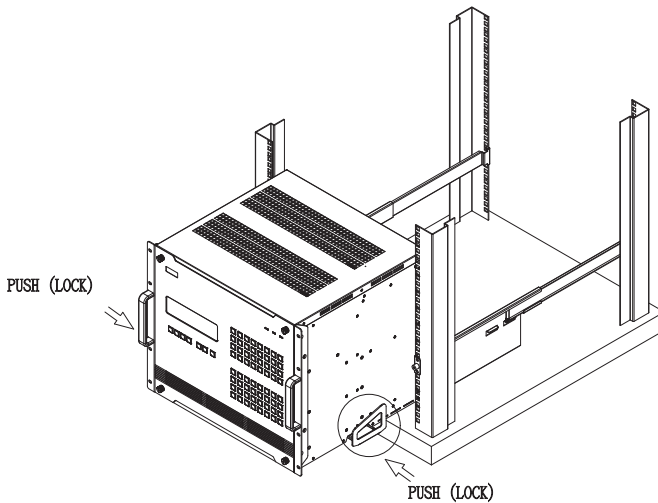

3. Screw the front panel to the rack.

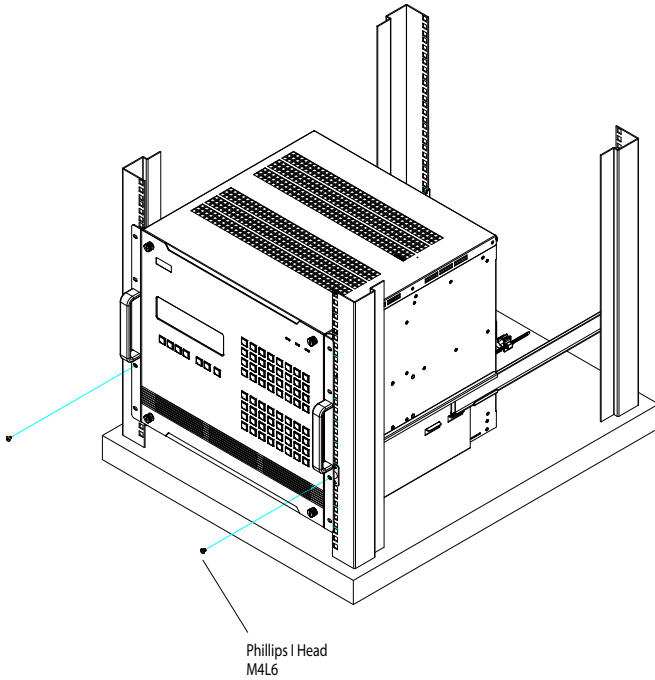

---

**Note:**

- ◆ Please allow 1U (44 mm) of space between the top of the VM3200 / VM3250 and any object to prevent obstruct of the air flow.
  - ◆ To ensure the VM3200 / VM3250 has sufficient air flow, do not stack items on top or in front of the unit. Proper air flow ensures safe operation and prevents the unit from overheating.
-

## Installation

Follow the steps below to safely install devices to the VM3200 / VM3250.

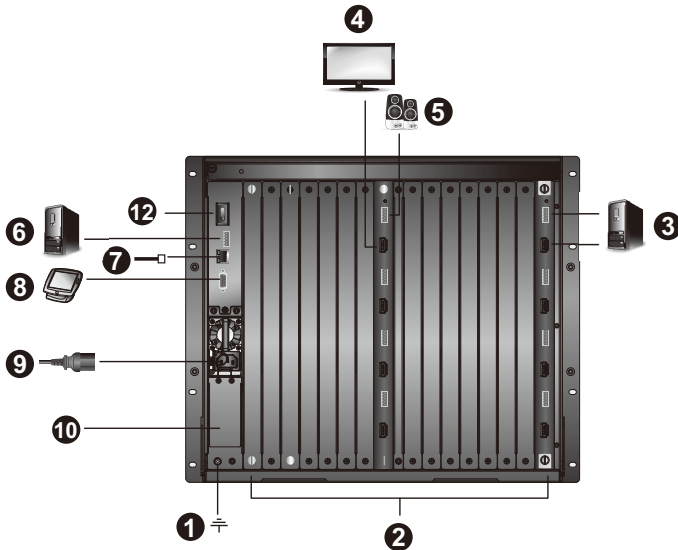

1. Use a grounding wire to ground the unit by connecting one end of the wire to the grounding terminal, and the other end of the wire to a suitable grounded object.

---

**Note:** Do not omit this step. Proper grounding helps prevent damage to the unit from surges or static electricity.

---

2. Install input and output boards to the VM3200 / VM3250. For detailed steps, see *Installing the Input / Output Boards*, page 39.
3. Connect one or more AV source devices to the **video and audio port(s)** of the input board(s) you installed.
4. Connect one or more video display devices to the **video port(s)** of the output boards you installed.
5. (Optional) Connect your speakers / audio output device(s) to the **audio port(s)** of the output boards you installed.
6. (Optional) To control multiple VM3200 / VM3250 units via serial communication, use an appropriate serial cable to connect a computer or a

serial controller to the VM3200 / VM3250's female RS-485 / RS-422 serial port. Use the supplied terminal block for this connection.

7. (Optional) To remotely operate the VM3200 / VM3250 via the web interface, plug an Ethernet cable into the Ethernet port on the VM3200 / VM3250.

---

**Note:** Use the Video Matrix Control app to remotely operate the unit. For more information, see *Video Matrix Control App User Manual*.

---

8. (Optional) To control the VM3200 / VM3250 via serial communication, use an appropriate serial cable to connect a computer or a serial controller to the female RS-232 serial port on the VM3200 / VM3250.
9. Install the power module.
  - a) Insert the supplied power module into the primary power slot.
  - b) Plug one end of the supplied power cord into the power module.
  - c) (Optional) Use the cable strap to hold the power cord in place.
  - d) Plug the other end of the power cord to a power source.

---

**Note:** Make sure the power module is stabilized into the VM3200 / VM3250 unit by gently pulling the power module. You should only be able to pull out the power module as you press the release lever.

---

10. (Optional) For redundant power, plug in a power module to the redundant power slot.

---

**Note:** Secondary power modules are not part of the standard VM3200 / VM3250 package. For more information on supported power modules, go to <https://www.aten.com/global/en/>.

---

11. Ground all the connected devices in your installation.
12. Power on the VM3200 / VM3250 and all devices in the installation.



---

## Installing the Input / Output Boards

---

To install input or output boards in the VM3200 / VM3250, follow the steps below.

---

**Note:** By default, the VM3250's EDID mode is set to true 4K. If you are using I/O boards that do not support a true 4K resolution, make sure to configure the VM3250's EDID mode and the resolution setting to avoid generating blank screens. To access these settings, use the front-panel pushbuttons (page 56) or the web interface (page 118).

---

1. On the rear of the VM3200 / VM3250, remove two screws from a left and right side slot, and then remove both covers.

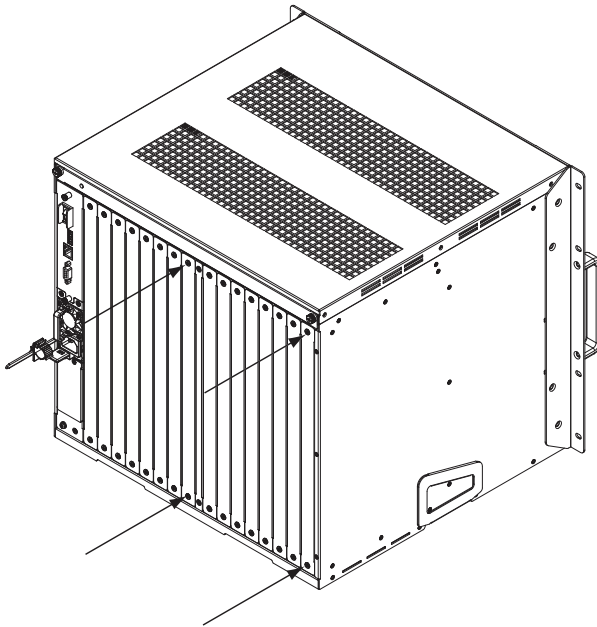

- Slide an output board into a left side slot and then tighten the two screws to secure the board to the VM3200 / VM3250.

---

**Note:** The eight slots toward the right are for input boards, and the other eight toward the left are for output boards.

---

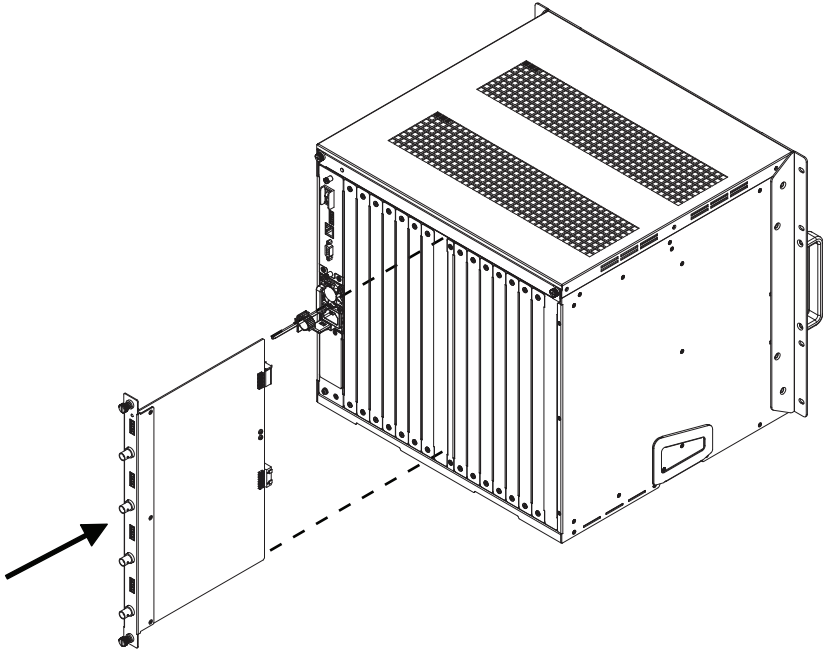

- Slide an input board into a right side slot and then tighten the screws to secure the board to the VM3200 / VM3250.

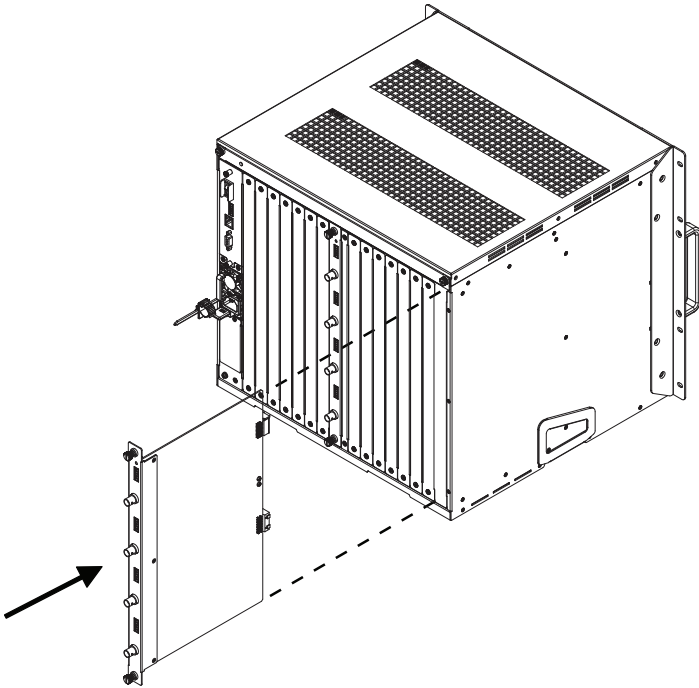

- Repeat steps 2 and 3 to install additional I/O boards.

This Page Intentionally Left Blank

# Chapter 3

## Front Panel Operation

### Overview

---

The Modular Matrix Switch installation can be configured and operated locally via the VM3200 / VM3250 front panel LCD and pushbuttons.



### Front Panel Pushbuttons

---

The VM3200 / VM3250 front panel has easy-to-use pushbuttons for selecting which video/audio source shows on which display.

#### Basic Navigation

The VM3200 / VM3250's front panel LCD display operation is easy and convenient. Please note the following front panel button operations:

- ◆ Press the **VIDEO** pushbutton to configure the video connections.
- ◆ Press the **AUDIO** pushbutton to configure the audio connections.
- ◆ Use the **MENU** pushbutton to access the Menu page options. For an overview of the settings in MENU, see *LCD Menu*, page 52.
- ◆ Use the **PROFILE** pushbutton to select a profile or switch between the connection profiles which have been added to the Profile List (see page 70).
- ◆ Use the **CANCEL** () pushbutton to go back a level, return to the Main screen, stop or exit an operation.
- ◆ Use the **UP** () and **DOWN** () pushbuttons to go to the next or previous options.
- ◆ Use the Input / Output (**1–32**) pushbuttons to select the Input/Output port. The pushbuttons may also correspond to menu options, profiles, and so on.

## Front Panel LCD

The VM3200 / VM3250 features an LCD display for convenient configuration. This allows you to perform operations such as viewing the IP settings, configuring the serial port, setting EDID/CEC/OSD/Output Status, selecting security settings, and loading/saving connection profiles.

### LCD Password

If the VM3200 / VM3250 has been configured to require a password for local operation (see *Security Mode*, page 61), the password screen appears when the VM3200 / VM3250 is powered on, and the cursor flashes on the first digit. Enter a 4-digit password to continue to the Main Screen.

**Note:** If you are accessing the VM3200 / VM3250 for the first time, the default password is 1234.

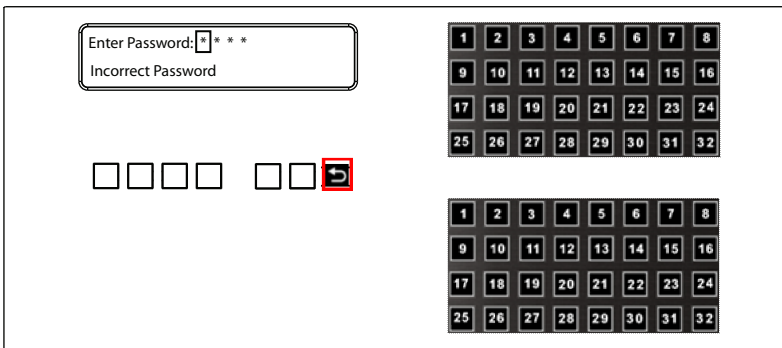

To enter a password, do the following:

1. Check that the cursor is flashing on the first digit.
2. Use the front panel number pushbuttons (1-9) to enter a 4-digit password. After the fourth digit, the cursor goes back to the first digit.

3. Press **Cancel** to clear the password. The digits revert to 4 asterisks (\*) and the cursor returns to the first digit.

---

**Note:** 1. The VM3200 / VM3250 password can be any four digit combination between 1111 to 9999.

2. If you enter an incorrect password, the cursor goes back to the first digit and reverts to flashing. The Incorrect Password message displays at the bottom of the screen, but clears as soon as a new digit is entered.
  3. If Password (see *Security Mode*, page 61) is Enabled, the LCD display time-out is 5 minutes by default.
-

## Port Switching

From the Main Screen, you can configure the Input-to-Output port connections to associate an Input source device to an Output display.

### Video / Audio Pushbutton

Before switching port connections, use the **Video** or **Audio** pushbuttons to select whether to switch only the video or the audio signal exclusively. Otherwise, both video and audio channels are configured together (default).

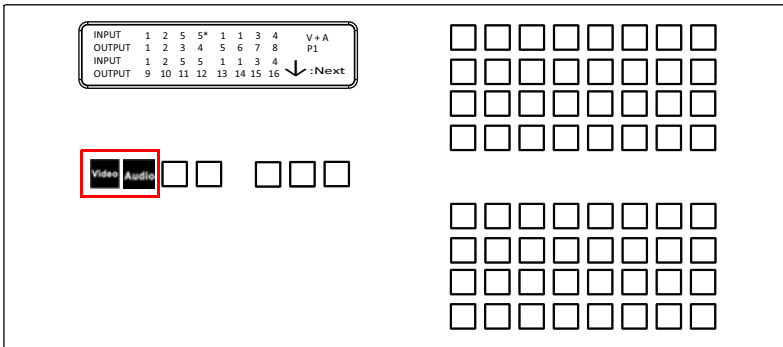

- ◆ Press the **Video\*** pushbutton to configure Video connections. The built-in LED lights up and the LCD displays **Video** on the lower right side. Press the button again to cancel.
- ◆ Press the **Audio\*** pushbutton to configure Audio connections. The built-in LED lights up and the LCD displays **Audio** on the lower right side. Press the button again to cancel.
- ◆ If both **Video** and **Audio** built-in LEDs are turned off, the video and audio channels are configured together and the LCD displays **V + A**.

**Note:** Press the **Video** or **Audio** pushbutton to independently switch either signal to a different source.



## Port Selection

### Input Port Selection

Use the Input Port pushbuttons to select the Input port you want to configure.

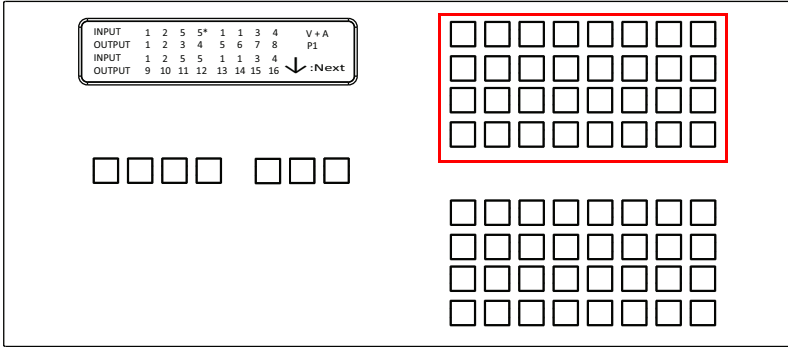

To select which input source displays on each output port, do the following:

1. Press an Input port pushbutton. The Output port LED(s) tied to the said Input port light up. In the example below, pressing Input port **1** shows it is tied to Output ports **1** and **2**.



2. To disconnect an Output port from an Input port, press the corresponding Output port pushbutton.

In the example below, Output port **2** has been disconnected from Input port **1**.



- To switch to another Input port, press any Input port pushbutton. The Output port LED(s) tied to the said Input port light up.  
In the example below, pressing Input port **2** shows it is tied to Output ports **3** and **4**.



- To connect Output port **2** to Input port **2** in the example above, press the Output port **2** pushbutton. The Output port **2** LED will also light up. This indicates that Input port **2** is now connected to Output ports **2**, **3** and **4**.



Once the signal from the selected Input port is successfully tied to the Output port, the LEDs turn off and the LCD information is updated.

- 
- Note:**
- Pressing an Input port a second time deselects it.
  - Input ports that are not configured or tied to any output port do not appear in the LCD screen.
  - Pressing the **Cancel** pushbutton once stops the Input Port Selection operation and the LCD displays the active setting. Pressing the **Cancel** pushbutton again turns all LEDs off.
  - After 10 seconds of inactivity, all the LEDs turn off.
-

## Output Port Selection

Use the Output Port pushbuttons to select the Output port you want to configure.

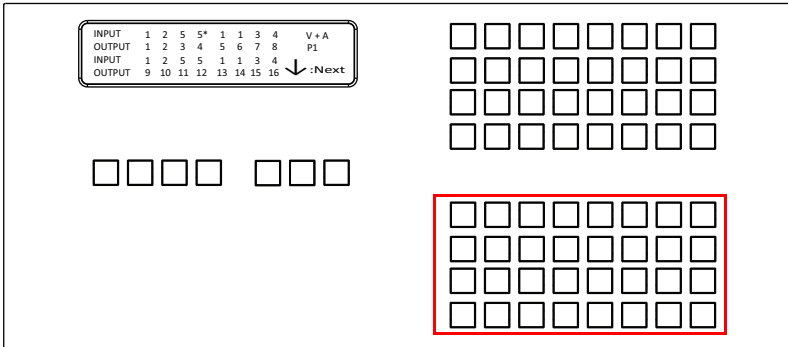

To select which output display corresponds to each input source, do the following:

1. Press any Output port pushbutton (1-32). The selected Output port LED lights steady.

In the example below, Output port **1** pushbutton has been pressed. Available Input ports light up. Because no Input LEDs are on, no ports have already been assigned to Output port **1**.

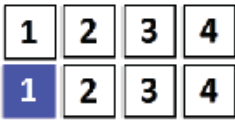

2. If an Output port pushbutton is pressed a second time, it is deselected and the LED turns off.
3. To connect the selected Output port(s) to an Input port, press the Input port pushbutton to which you want the Output port(s) tied. The newly selected Input port LED light up, and the LCD information is updated.

In the example below, pressing Input port **2** ties it to Output ports **2, 3** and **4**.



- To switch Output ports **2**, **3** and **4** to another Input port (and disconnect it from Input port **2**), press another Input port pushbutton to which you want them tied.

In the example below, Input port **3** has been pressed and is now connected to Output ports **2**, **3** and **4**.



---

**Note:**

- ◆ To cancel an output selection, press the pushbutton again.
  - ◆ Pressing the **Cancel** pushbutton once stops the Output Port Selection operation, and the LCD displays the active setting. Pressing the **Cancel** pushbutton again turns all LEDs off.
  - ◆ After 10 seconds of inactivity, all the LEDs turn off.
-

## Profile Pushbutton

From the Main screen, pressing the **PROFILE** pushbutton switches between the connection profiles added to the Profile Selection list (see *Profiles*, page 70). If a connection profile is in use, it is shown from the Main screen on the lower right corner of the LCD display.

INPUT	1	2	5	5*	1	1	3	4	V+A
OUTPUT	1	2	3	4	5	6	7	8	
INPUT	1	2	5	5	1	1	3	4	
OUTPUT	9	10	11	12	13	14	15	16	↓:Next



- ◆ Use the front panel number pushbuttons to select a profile:
  - ◆ **Input** ports 1–32 correspond to Profile **P1** to **P32**
  - ◆ **Output** ports 1–32 correspond to Profile **P33** to **P64**

---

**Note:** If a Profile is available for selection, its corresponding Input/Output port LED lights.

---

The selected pushbutton lights steady, and the VM3200 / VM3250 immediately applies the port connections configured in the Profile. The selected Profile is shown as **P1-P64** in the LCD's lower right corner.

- ◆ **Up** and **Down** buttons correspond to the previous or next profile in the Profile List, which can be edited via the GUI.

If there are no profiles configured, an error message “*No Profile List defined. Profile List can be edited via the Web GUI.*” is displayed.

- ◆ The Profile List and connections can be edited from the *Profile List* page of the Browser GUI. See *Profiles*, page 70.
- ◆ Press the **Cancel** pushbutton to turn off the Profile LED.

## LCD Menu

Use the **Menu** pushbutton to switch between the Main Screen and Menu page. From the Main Screen press the **Menu** pushbutton to access the Menu page; use the pushbuttons (1-32) to cycle through the menu options, starting from IP Setting, in the order show in the table below:

Menu Page	Sub-Menu Page(s)			
IP Setting	IP Address			
	Subnet Mask			
	Gateway			
Serial Port Setting	Baud Rate	9600 / <b>19200</b> / 38400 / 115200		
Operation Mode	EDID	<b>Default</b> / Port1 / Remix / Customized		
	CEC	On / <b>NA</b>		
	OSD	<b>On</b> / NA		
	Output Status	Video	<b>On</b> / NA	
		Stereo Audio	01-32	
Output Resolution		01-32		
Security Mode	Mode	<b>None</b>		
		Password Enable		
		Lock Screen		
	Change Password	Old Password	New Password	
Play the Profile Schedule				
Stop the Profile Schedule				
Standby Mode				
Break Output Group				

### Note:

- ♦ Default settings are indicated in bold. Upon VM3200 / VM3250 startup, check the front panel LCD to view the loading progress. If the LCD Menu fails to load, an error message displays. Reset the unit and try again.

## LCD Main Screen

The Main Screen shows the Input–Output port pairs, with the Output ports shown in sequential order (1–16) at the bottom half.

INPUT	1	2	5	5*	1	1	3	4	V + A
OUTPUT	1	2	3	4	5	6	7	8	
INPUT	1	2	5	5	1	1	3	4	
OUTPUT	9	10	11	12	13	14	15	16	↓: Next

- ◆ The front panel pushbutton label (1–32) corresponds to the **Input** ports and **Output** ports on the unit's rear panel.
- ◆ Use the **Down** pushbutton to go to the next page to view ports 17–32.
- ◆ Use the **Menu** pushbutton to go to the Menu page.
- ◆ Use the **Profile** pushbutton to switch between profile connections (see *Profiles*, page 70).
- ◆ The audio transmission from a port is muted or not connected if there is a \* symbol right next to the port number, e.g., 5\*.
- ◆ The audio transmission from a port is extracted if there is a x symbol right next to the port number, e.g., 5x.

## IP Setting

---

To view the VM3200 / VM3250's IP settings, press the **Menu** pushbutton (lights). This takes you to the Menu page, shown below:



1. From the Menu page:
  - ◆ Press **1** to go to the IP Setting page.
  - ◆ Press **2** to go to the Serial Port Setting page.
  - ◆ Press **3** to go to the Operation Mode page.
  - ◆ Press **4** to go to the Security Mode page.
  - ◆ Press **Down** button to go to the next page.
  - ◆ Press **Menu** to return to the Menu Screen.
  - ◆ Press **Cancel** to return to the Main Screen.
2. After pressing **1**, the IP address, Subnet Mask and Gateway information are shown:

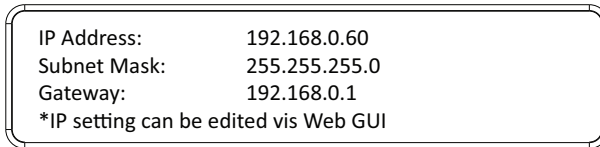

- ◆ The default IP address is 192.168.0.60.
  - ◆ The default Subnet Mask is 255.255.255.0.
  - ◆ The default Gateway is 192.168.0.1.
3. Press **Cancel** to return to the previous step without change.



## Serial Port Setting

---

To configure the VM3200 / VM3250's serial port settings, select Serial Port Setting from the Menu page.

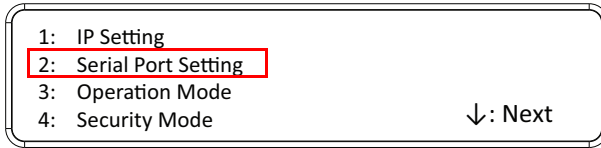

### Baud Rate

1. Select **Baud Rate Setting** from the Serial Port Setting by pressing **1**:

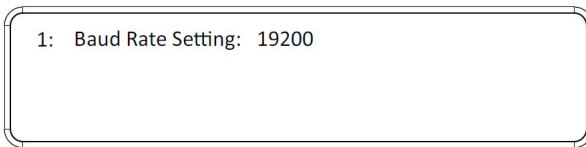

2. Press pushbuttons 1–4 to make your selection.

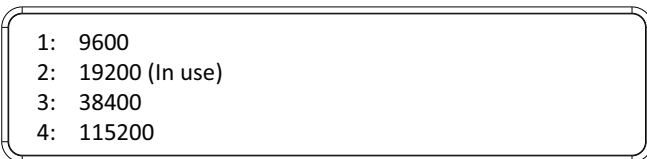

Baud Rate options are:

- ◆ 1: 9600
- ◆ 2: 19200
- ◆ 3: 38400
- ◆ 4: 115200

---

**Note:** The default baud rate is 19200.

---

3. Press **Menu** to return to the Menu page.
4. Press **Cancel** to return to the previous step without saving.

## Operation Mode

The EDID, CEC, OSD, and Output Status features are adjusted from the Operation Mode menu.

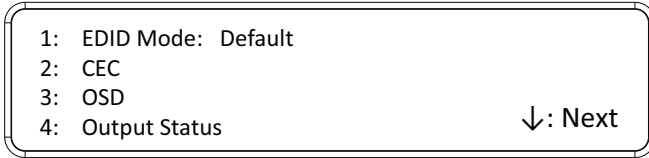

- ◆ EDID (extended display identification data) is used to apply a preset video configuration (EDID Mode), which utilizes the best resolution across different monitors.
- ◆ Consumer Electronics Control (CEC) allows interconnected HDMI devices to communicate and respond to one remote control.
- ◆ The OSD, when enabled for a port, displays real-time port switching information on the screen.
- ◆ The Output Status shows whether the video/audio of an Output port is turned on or off.

### EDID

To adjust the EDID mode, do the following:

1. From the Operation page, press pushbutton **1** to access the EDID Mode page:

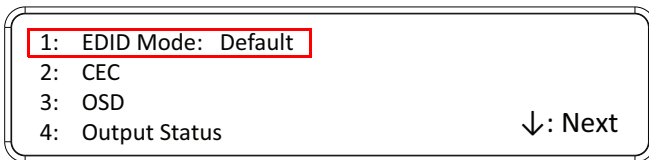

2. Press pushbuttons 1-4 to make your selection.

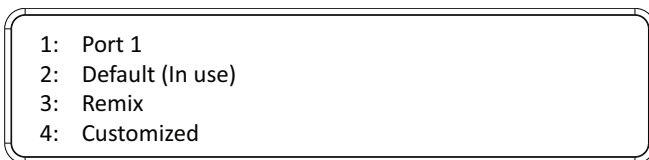

EDID Mode options are:

EDID Option	Description
1: Default	ATEN's default EDID data is passed to all video sources by default when the system is powered on.
2: Port1	EDID data read from port 1 is passed to all video sources. The system will enforce the Default EDID setting if port 1 is not occupied.
3: Remix	This mode reads the EDID data from all connected displays and generates the optimum EDID for all video sources. The system will not re-generate a new EDID when a new device is plugged in, unless triggered by a pushbutton or command.
4: Customized	This mode features an EDID Wizard that allows user-defined EDID configurations for optimum output. See <i>EDID Settings</i> , page 118.

3. Press **Menu** to return to the Menu page.
4. Press **Cancel** to return to the previous step without change.

---

**Note:** The default EDID setting is Default.

---

## CEC

To configure the CEC settings, do the following:

1. From the Operation page, press pushbutton **2** to access the CEC page:

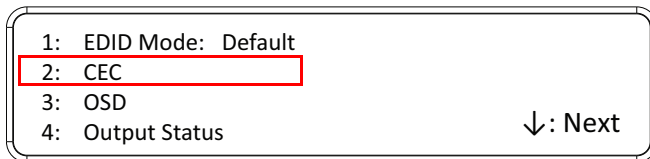

2. Press pushbuttons 1–32 to enable (**ON**) or disable (**NA**) the CEC feature for the output port. If the port does not support CEC, an **NA** is shown.

OUTPUT	1	2	3	4	5	6	7	8
	NA	NA	NA	NA	ON	NA	ON	NA
OUTPUT	9	10	11	12	13	14	15	16
	ON	ON	ON	ON	NA	NA	NA	NA

↓: Next

---

**Note:** The default CEC setting is Off.

---

3. Press **Menu** to return to the Menu page.
4. Press **Cancel** to return to the previous step without saving.

### OSD

The On-Screen Display or OSD feature enables real-time text updates to appear on the display device’s screen for any configuration changes made to the Output port via the VM3200 / VM3250’s front panel, remote control or Web GUI.

To configure the OSD setting for each output port, do the following:

1. From the Operation page, press pushbutton **3** to access the OSD page:

1: EDID Mode: Default
2: CEC
3: OSD
4: Output Status

↓: Next

2. Press pushbuttons 1–32 to enable (**ON**) or disable (**NA**) the OSD feature for the port.

OUTPUT	1	2	3	4	5	6	7	8
	NA	NA	NA	NA	ON	NA	ON	NA
OUTPUT	9	10	11	12	13	14	15	16
	ON	ON	ON	ON	NA	NA	NA	NA

↓: Next

---

**Note:** The default OSD setting is Off.

---

3. Press **Menu** to return to the Menu page.
4. Press **Cancel** to return to the previous step without saving.

## Output Status

To configure the Output Status settings for each output port, do the following:

- From the Operation Mode screen, press pushbutton **4** to access the Output Status page:

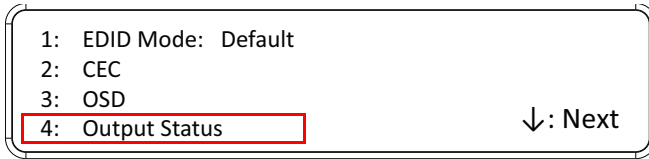

- Press pushbuttons 1–3 to select whether you want to configure the video, stereo audio, or output resolution for output ports.



- If configuring the output port status for video, press pushbuttons 1–32 to enable (**ON**) or disable (**NA**) the video channel:

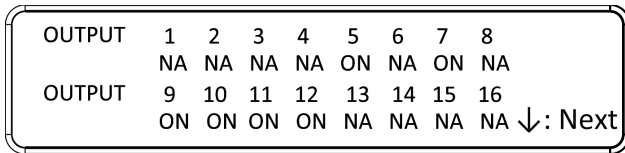



---

**Note:** The default Output Status setting is On.

---

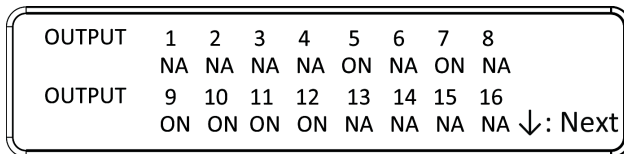
- If configuring the output port status for stereo audio, press pushbuttons 1–32 to select the output port. Adjust the audio volume for the port by pressing the **Up** or **Down** pushbutton:



---

**Note:** The audio volume range from 0 (mute) and 1 (~27dB) to 10 (0dB). The default audio volume is 10.

---

5. If configuring the output video resolution, press pushbuttons 1–32 to select the output port. Next, select the preferred output resolution.
6. Press **Menu** to return to the Menu page.
7. Press **Cancel** to return to the previous step without saving.

## Security Mode

The Security Mode page allows you to configure the VM3200 / VM3250's password-related settings; the **Password** page sets the VM3200 / VM3250 to require a password for local operation after the LCD display times out (default time out: 5 minutes) or is powered off/on. The **Change Password** option allows you to set a new password for the VM3200 / VM3250.

To configure the VM3200 / VM3250's password settings from the Main Screen, use the **Menu** pushbutton to access the Menu page, then press pushbutton **4** to access the Security Mode page.

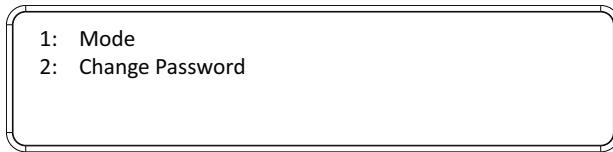

### Mode

1. To set the VM3200 / VM3250 so that it requires a password for local operation, press pushbutton **1** in the Security Mode page.

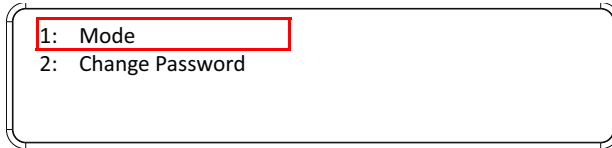

2. To disable security settings, press pushbutton **1**.
3. To require a password after the LCD display times out or is powered off/on, press pushbutton **2**.
4. To enable a lock screen, press pushbutton **3**. When Lock Screen is enabled, pressing any pushbutton from the home screen will trigger the following message: *Please press "Menu" to start.*



**Note:** By default the password requirement is disabled. If the password is enabled, the LCD display's default time-out is 5 minutes.

5. Press **Menu** to return to the Menu page.
6. Press **Cancel** to return to the previous step without saving.

## Change Password

1. To change the password: from Security Mode, press pushbutton **2**.

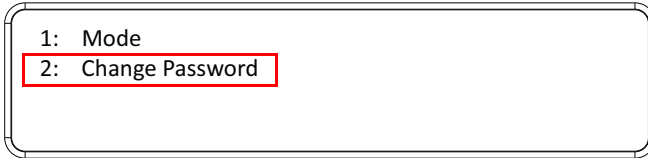

2. In the Old Password field, the cursor flashes at the first digit. Enter the old password (see *LCD Password*, page 44). If the old password is entered correctly, you can proceed to the next step. The default password is: **1234**.

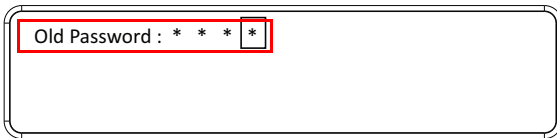

---

**Note:** If you enter an incorrect password, the cursor goes back to the first digit and reverts to flashing. The Incorrect Password message clears as soon as a new digit is entered.

---

3. In the New Password field, the cursor flashes at the first digit. Enter the new password using the front panel number pushbuttons (1111–9999).



4. Re-enter the new password in the following screen. The new password is applied by the VM3200 / VM3250 immediately.

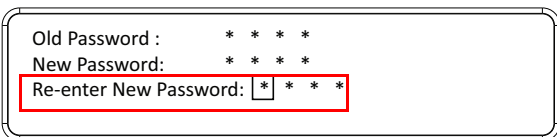



If the password you entered does not match the one entered in the previous screen, an error message appears. Enter the new password correctly.

5. Press **Menu** to return to the Menu page.
6. Press **Cancel** to return to the previous step without saving.

## Playing/Stopping the Profile Schedule

---

You can start or stop playing a pre-configured profile schedule using the front panel. To start/stop playing profile schedule, follow the steps below.

1. Press the **Menu** pushbutton and press the **Down** pushbutton to navigate to **Play the profile schedule** or **Stop the profile schedule**.
2. Press pushbutton **1** or **2** to activate the function.

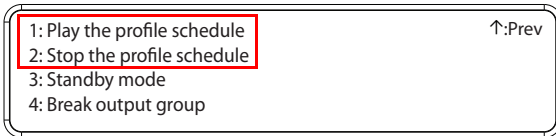

For more information about configuring profiles and profile schedule, see *Profiles*, page 70 and *Profile Scheduling*, page 96

## Enabling/Disabling the Standby Mode

---

The standby mode is a low-power mode where the VM3200 / VM3250 operates minimally by stopping all input and output transmissions and logging the user out of the web GUI.

To enable/disable the standby mode, follow the steps below.

1. Press the **Menu** pushbutton and press the **Down** pushbutton to navigate to **Standby mode**.
2. Press pushbutton **3** to activate the function.

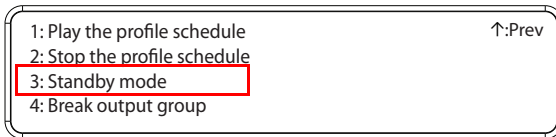

---

## Breaking Output Groups

---

You can disintegrate a grouped display (video wall) into individual displays. For example, if you have three 2 x 2 display zones (video walls) set up, and each is playing a profile, you can enable this function to have the assigned source displayed separated on each of the 4 monitors. Note this function is only available when a display zone is displaying a profile that contains grouped output.

To enable this function, press the **Menu** pushbutton and press the **Down** pushbutton to navigate to the option and press pushbutton **4** to activate the function.

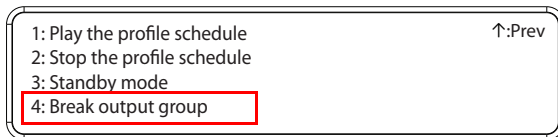

This Page Intentionally Left Blank

# Chapter 4

## Browser Operation

### Overview

---

The VM3200 / VM3250 can be configured over a standard TCP/IP connection via its built-in Graphical User Interface (GUI). Because it can be accessed from anywhere over a network or the Internet, operators can easily log in via web browser. Security is ensured by password protection and user-configurable time-out. The VM3200 / VM3250 supports three levels of remote users with various privileges, and up to 16 users can log into the GUI at one time. For full details see the sections that follow.

### Logging In

---

To access the GUI, type the VM3200 / VM3250's IP address into the address bar of any browser. If a Security Alert dialog box appears, accept the certificate – it can be trusted. The login screen appears:

Username

Password

Remember this account

 English

Login

- ◆ The default IP address is **http://192.168.0.60**
- ◆ The default Username and Password are: **administrator / password**
- ◆ Enter the username and password, then click **Login**.
- ◆ Check **Remember this account** to save the Username and Password.
- ◆ Use the drop-down menu to select the GUI language

---

**Note:** 1. The username supports lower case letters only.

2. The same user can not be logged in simultaneously.

---

# Main Page

The Main Page opens to the **Profile List**. Use the Profile List page to configure profiles which define input to output connections. The page is divided into three parts— the *Menu Bar* (page 69), *Profile List* (page 70), and *Profile Scheduling* (page 96).

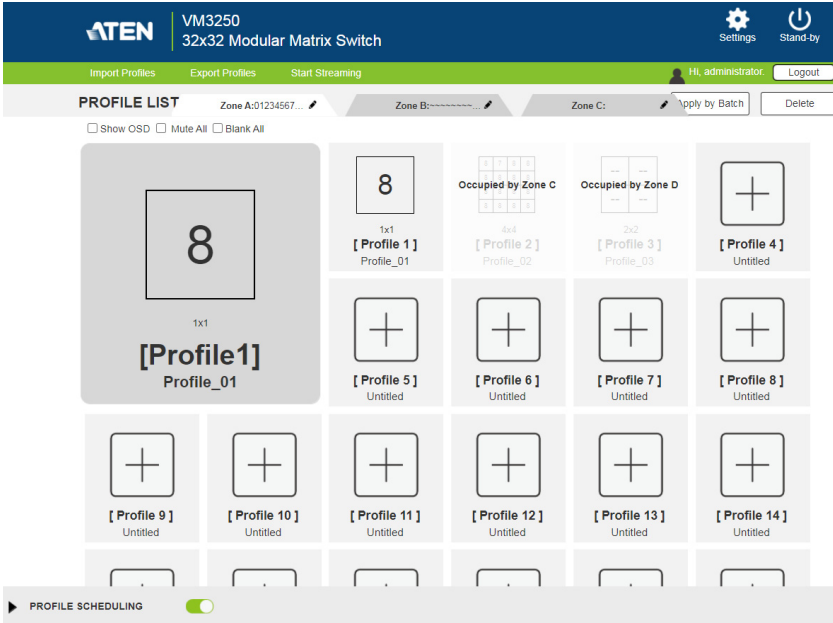

## Menu Bar

The Menu Bar provides the following controls:

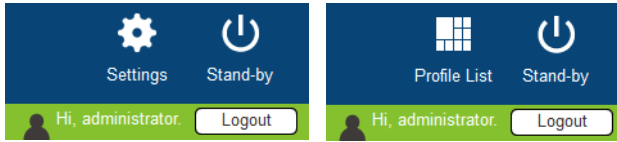

Control	Description
Settings	Click to access the system settings. For details, see <i>System Settings</i> , page 104.
Profile List	Click to access settings on adding or editing profile adding/editing, profile import/export, and profile scheduling. For details, see <i>Profiles</i> , page 70.
Standby	Click to set the VM3200 / VM3250 to standby mode. For details, see <i>Profiles</i> , page 70.
Logout	Click to log out of the VM3200 / VM3250 web GUI.

### Setting the Standby Mode

The standby mode is a low-power mode where the VM3200 / VM3250 operates minimally by stopping all input and output transmissions and logging the user out of the web GUI.

To enable the standby mode, click  from the menu bar in the VM3200 / VM3250 web GUI.

To disable the standby mode, do one of the following:

- ◆ Press the **Menu** pushbutton from the device panel
- ◆ Log in the web GUI with a valid credential

# Profiles

## Understanding Profiles and Profile List

A profile is a set of settings that specifies how audio and video sources are to be displayed or played on one or more video walls and speakers. You can create and save up to 64 profiles to the Profile List to be conveniently switched via the front panel, web console (GUI), or the Video Matrix Control app as needed.

**Note:** For more information on the Video Matrix Control app, see *Video Matrix Control App User Manual*.

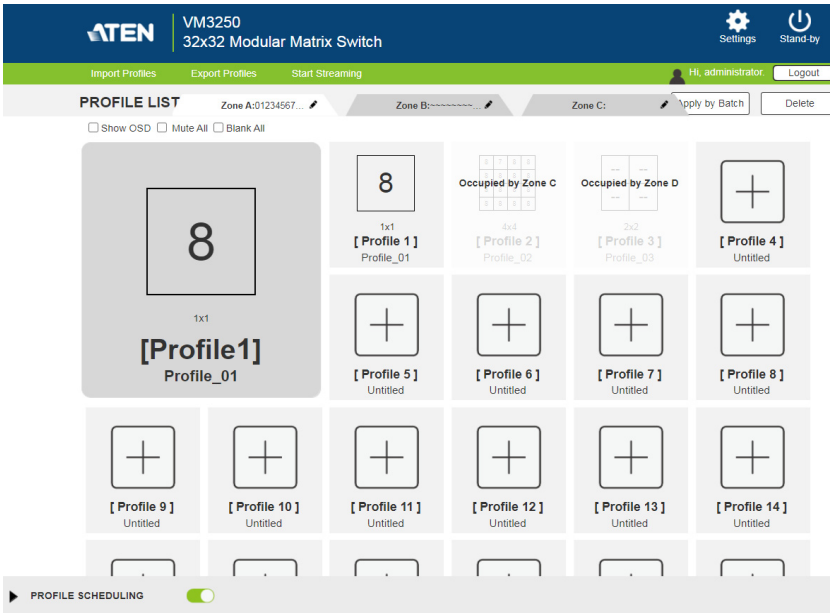





## Understanding Display Zones

In your modular matrix switch application, you may have more than one video wall set up – for example, a 2 x 2 video wall, a 4 x 4 video wall, and a single-monitor display, all managed by one VM3200 / VM3250. In this case, you have three display zones. To be able to switch profiles independently on just one display zone, instead of on all the display zones, use the zone tabs to help you organize and create profiles. You can create profiles for up to 4 display zones. A profile created for a display zone can only be configured under that display zone.

### Example

In the illustrated Profile List below, the profiles are created for three display zones (A, B, and C). Three profiles (profile 1 to 3) are created for zone A, and profile 4 to 6, created under zone B and C are not configurable under zone A.

**PROFILE LIST** Zone A:  Zone B:  Zone C: 

Show OSD  Mute All  Blank All

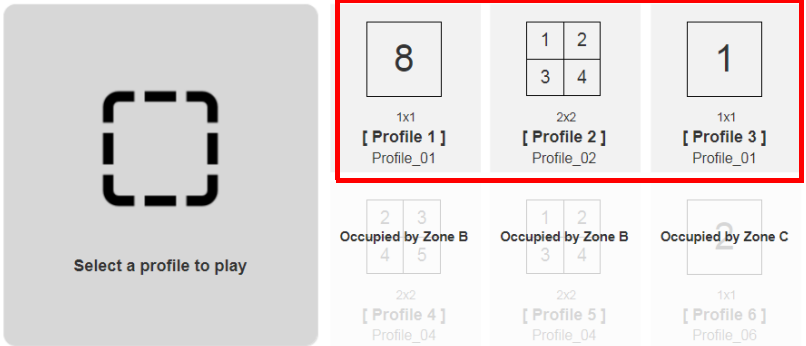

Select a profile to play

1x1 [ Profile 1 ] Profile\_01



2x2 [ Profile 2 ] Profile\_02

1x1 [ Profile 3 ] Profile\_01

2x2 [ Profile 4 ] Profile\_04

2x2 [ Profile 5 ] Profile\_04

1x1 [ Profile 6 ] Profile\_06

**PROFILE LIST** Zone A:  Zone B:  Zone C: 

Show OSD  Mute All  Blank All

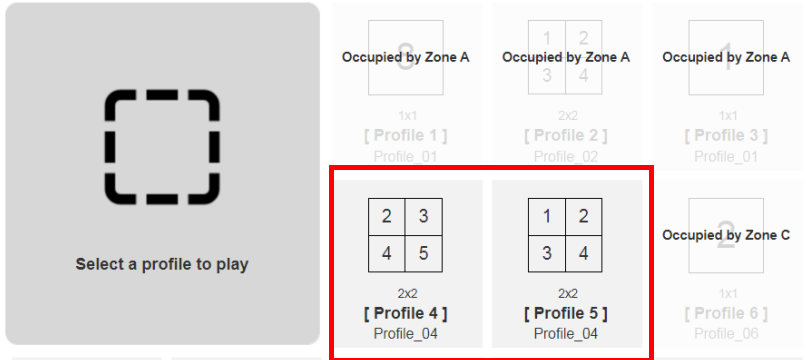

Select a profile to play

1x1 [ Profile 1 ] Profile\_01

2x2 [ Profile 2 ] Profile\_02

1x1 [ Profile 3 ] Profile\_01

2x2 [ Profile 4 ] Profile\_04

2x2 [ Profile 5 ] Profile\_04

1x1 [ Profile 6 ] Profile\_06

## Creating a Profile

- Prepare and gather the following information.
  - Know which display zone the profile is created for.  
For information on the working of profiles on multiple display zones, see *Understanding Display Zones*, page 71.
  - For easier switching, create profiles for a particular zone in consecutive profile numbers. For example, you can reserve profile 1 to 10 for zone A, profile 11 to 20 for zone B, etc.
- (Optional) To name or re-name a display zone, click  on the zone tab.
- From the Profile List, click the zone tab of the display zone to which you want to apply the profile.

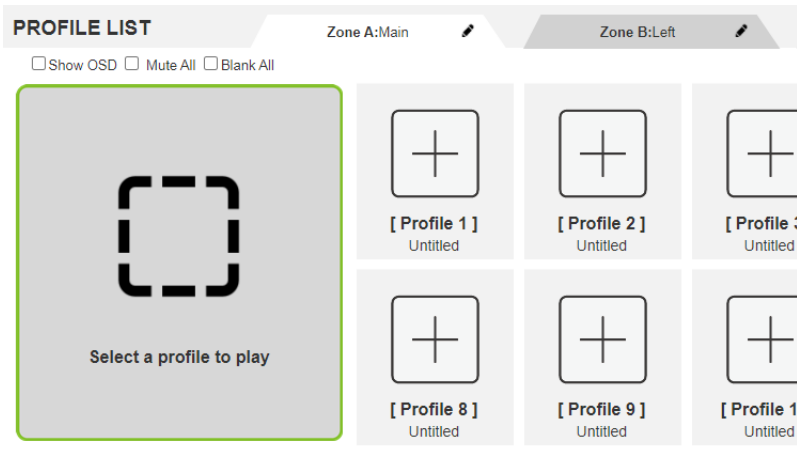

- Click  from an empty profile. This window appears.

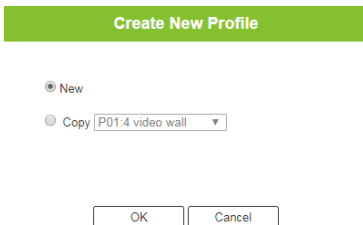

5. Follow the on-screen instructions to select a template and define the number of displays for the display zone.
  - ◆ **New:** Select this option to configure a profile from scratch.
  - ◆ **Copy:** Select this option to configure a profile based on an existing profile.

This screen appears. In this example, the profile is set to a quad view (2 x 2 divisions) using 16 displays.

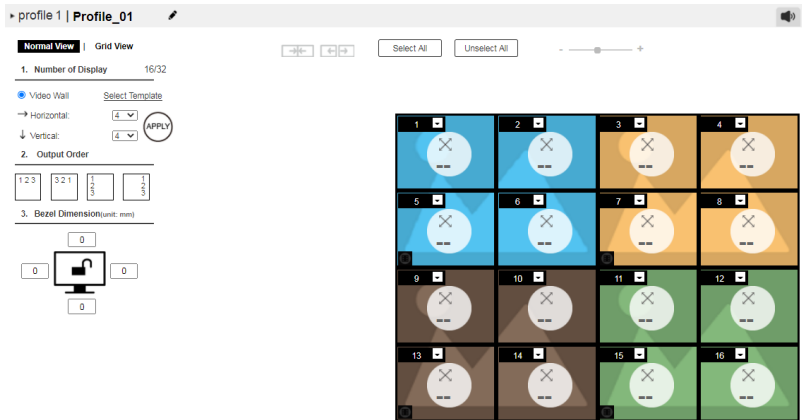

6. Click on each display in the preview and specify its video input and scaling preference. The selected input port is immediately indicated as the big number in the selected display.

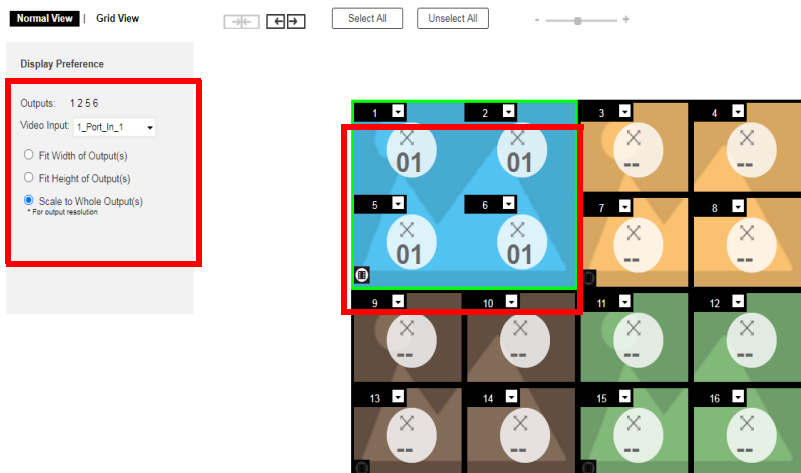

- Click **Save** to finish the configuration. The profile immediately appears in the Profile List.

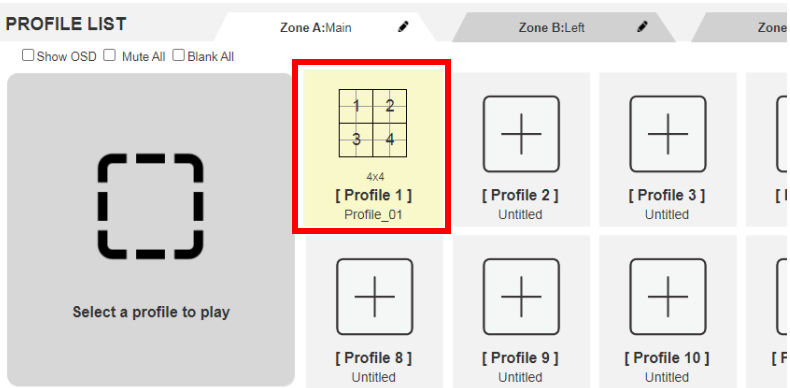

## Configuring Video Settings of a Profile

1. In the Profile List, locate the profile you wish to configure by clicking the zone tab.
2. Click the profile and then click **Edit**. This screen appears.

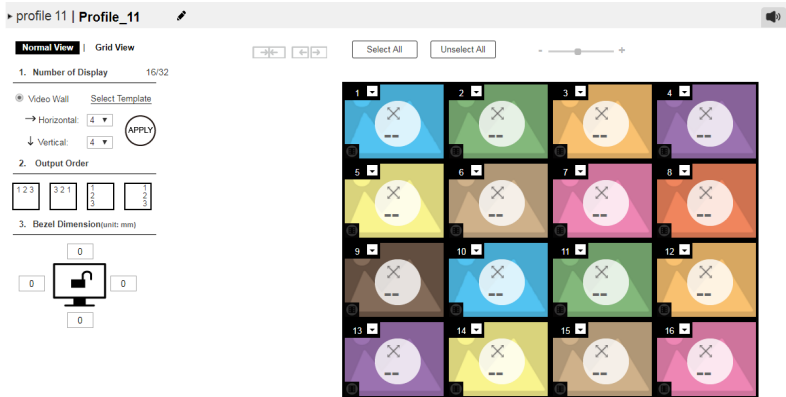

3. You can choose either the **Normal View** or the **Grid View** to edit the profile.

### Normal View

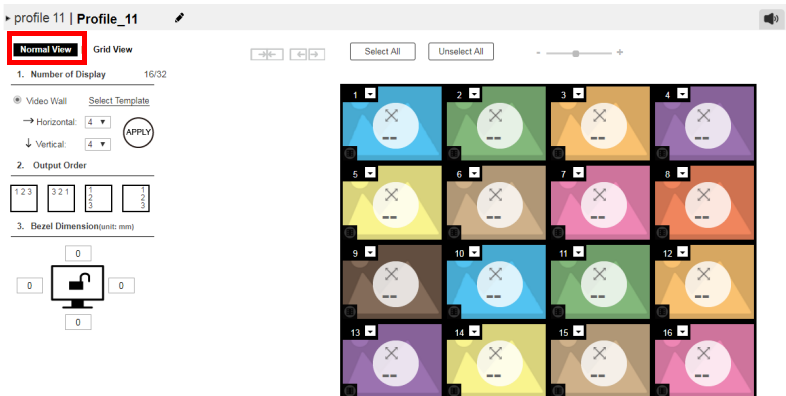

- ◆ On top of video and audio assignments, the Normal View also allows you to configure the number of monitors and the bezel dimensions of the profile.
- ◆ For detailed information, see *Configuring Video Settings in Normal View*, page 77.

## Grid View

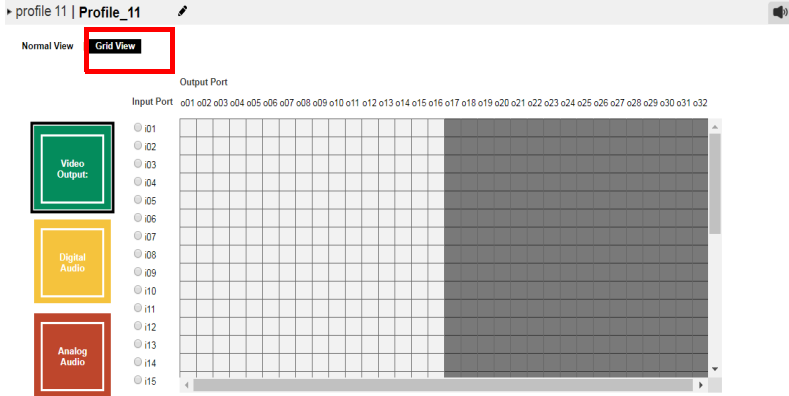

- ◆ In grid view, the audio and video outputs are assigned by mapping the audio/video input on the vertical axis to the audio/video output on a horizontal axis.
  - ◆ For detailed information, see *Configuring Video Settings in Grid View*, page 83.
4. (Optional) Click **Test** to apply your configuration without saving it.
  5. To save your configuration, click **Save & Apply**, **Save**, or **Save As**.

## Configuring Video Settings in Normal View

### Profile Layout Settings

**Normal View** | Grid View

#### 1. Number of Display 16/32

Video Wall [Select Template](#)

→ Horizontal:

↓ Vertical:

#### 2. Output Order

#### 3. Bezel Dimension(unit: mm)

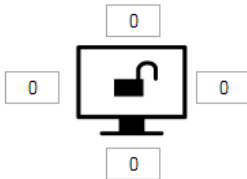

Control	Description
Number of Displays	<p>Use the following controls to configure the layout type and the number of displays.</p> <ul style="list-style-type: none"> <li>♦ <b>Video Wall:</b> Select this option for displays that are tiled together, where multiple monitors form one large screen – in various arrangements.</li> </ul> <p><b>Note:</b> To ensure synchronized video outputs on your video wall, configure the Hold Time setting of the VM3200 / VM3250 if you are using any VE805R / VE816R with the VM8514. For detailed information, please visit ATEN's official website, go to Help Center (FAQ), and search for the information.</p> <ul style="list-style-type: none"> <li>♦ <b>Select Template:</b> Click to open a window that allows you to select a predefined video wall layout.</li> <li>♦ <b>Horizontal / Vertical:</b> Use these drop-down lists to select the number of displays that make up the video wall (a maximum of 64 are supported). Match this to the physical layout of the displays.</li> </ul> <p><b>Note:</b> Click <b>Apply</b> to save the changes. A preview of the profile is shown on the right of the screen.</p>
Output Order	Click any of the listed options to automatically assign output ports.

Control	Description
Bezel Dimension	Use the four boxes to increase/decrease the frame size for each active display.
Monitor Lock / Unlock	Click the monitor icon to <b>Lock</b> the (4) bezel settings, so that when one size is changed they all change. Click the monitor icon to <b>Unlock</b> the (4) bezel settings, so that each size can be set independently.

## Display Preferences

To configure the display preferences for one or more displays, click the display(s) in the preview, the Display Preference settings page appears. Configure the settings as required.

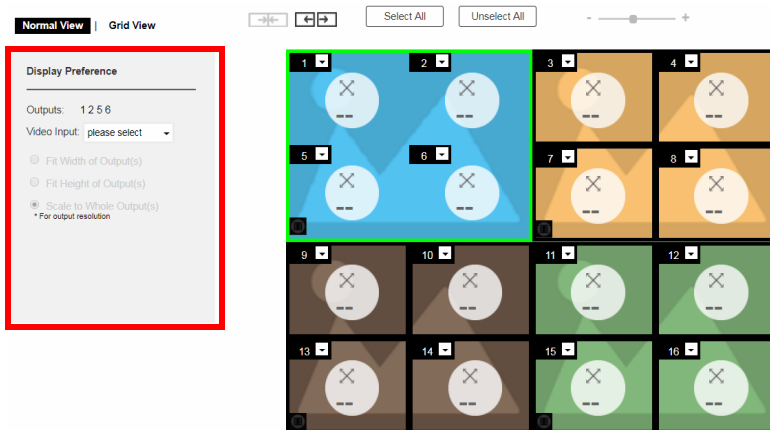



Option	Description
Output	This indicates the selected displays.
Video Input	Click to select a video source for the output(s). The chosen video source (port number) is indicated at the center of the output(s) in the preview.
Radio Button	<ul style="list-style-type: none"> <li>◆ <b>Fit Width of Output(s)</b>: fits the video to the width of the display.</li> <li>◆ <b>Fit Height of Output(s)</b>: fits the video to the height of the display.</li> <li>◆ <b>Scale to Whole Output(s)</b>: fits the video on the entire display.</li> </ul>

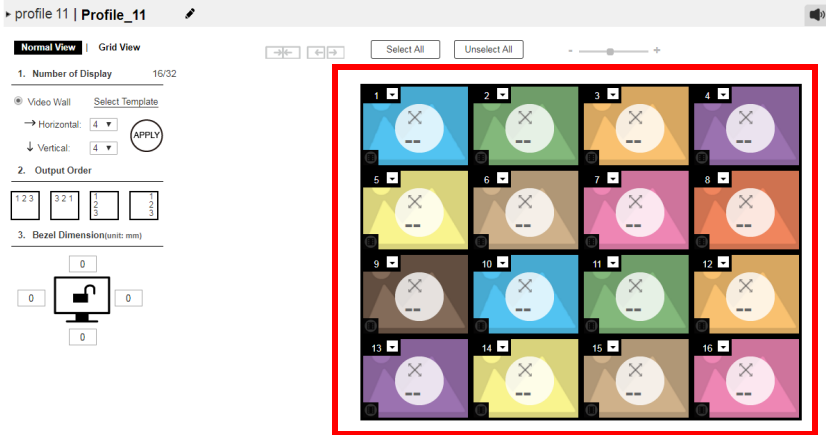

## Video Wall Settings

Each icon represents an Output port and the connected display. Use the icons to create Independent and Grouped Outputs. **Independent** Outputs will display video on a single monitor. **Grouped** Outputs will display video across multiple monitors as one large screen.



- ◆ Click an icon to choose its **Output** and **Video Input** from the *Display Preference* menu (see *Display Preferences*, page 78).
- ◆ Click multiple icons to Group Outputs (see *Grouping*, page 81).
- ◆ Click **Select All** to select all outputs.
- ◆ Click **Unselect All** to unselect all outputs.
- ◆ Use the sidebar to zoom in and out of the display layout.
- ◆ On the *Top Bar* click:
  - ◆  to rename the profile
  - ◆  to configure audio outputs

**Null Input**

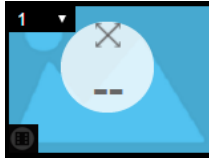

Option	Description
Null Icon	<p>Click Null Input icons to highlight icons in green and use the Display Preferences menu to set the video options (see <i>Display Preferences</i>, page 78).</p> <p>Select a <b>single</b> icon to set the <b>Output</b> and <b>Video Input</b> for an independent display (see <i>Independent Output</i>, page 80).</p> <p>Select <b>multiple</b> icons and set the <b>Video Input</b> to group displays as one screen (see <i>Grouping</i>, page 81). <i>You must first set the Output port for each icon.</i></p>
Drop-down Menu	Use the drop-down menu to select the Output port.

**Independent Output**



Option	Description
Independent	<p>Independent Outputs are displays that have their own <b>Video Input</b> and <b>Output</b> selected. Independent Outputs:</p> <ul style="list-style-type: none"> <li>◆ Display their own video</li> <li>◆ Icons have their own color and Video Input</li> </ul> <p>Select an Independent Output and use the <i>Display Preferences</i> menu to select the <b>Video Input</b> (see page 78).</p>
Drop-down Menu	Use the drop-down menu (top-right corner) to select the Output port.
Video	Click the <b>video</b> icon to turn the video off/on.



## Grouping

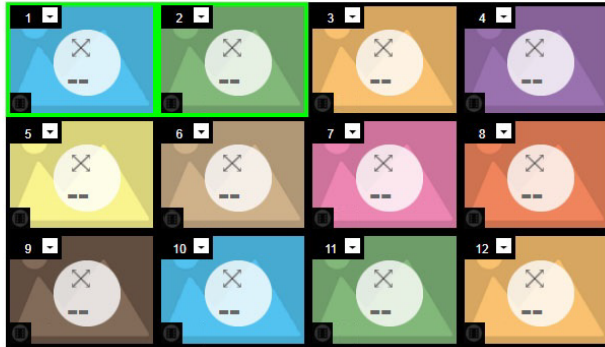

Option	Description
Grouping	Click multiple icons to Group Outputs (highlighted in green) and click → ← to group the displays into one screen. Use the <b>Display Preferences</b> menu to select the <b>Video Input</b> for the group - each Output icon in the Group will appear with the same Video Input number and icon color (see page 78).
Ungroup	Select a group and click ← → to ungroup the displays.

## Group



Option	Description
Group	<p>A <b>Group</b> (of Outputs) shares the same <b>Video Input</b> and displays the video together as one large screen. A Group of Outputs:</p> <ul style="list-style-type: none"> <li>◆ Displays video across multiple monitors to form one screen</li> <li>◆ Icons have the same color and Video Input number.</li> <li>◆ Select a Group and use the <i>Display Preferences</i> menu to select the <b>Video Input</b>.</li> <li>◆ To group outputs see <i>Grouping</i>, page 81.</li> </ul>
Video	Click the <b>video</b> icon to turn the video off/on.



### ***Video Wall Example 1***

This example shows a video wall with 8 displays.

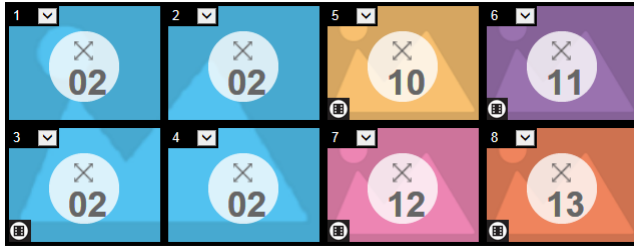

- ◆ This video wall has 1 **Group** and 4 **Independent** displays.
- ◆ Each *Group* and *Independent* Output has a unique color.
- ◆ The **Blue** Group will show video **Input 02** across all four displays as one large screen.
- ◆ The Independent displays will show the video from their own video **Input 10, 11, 12 and 13**.

### ***Video Wall Example 2***

This example shows a video wall with 16 displays.

- ◆ This video wall has 3 **Groups** and 2 **Independent** displays.
- ◆ Each *Group* and *Independent* Output has a unique color.
- ◆ The **Blue** Group will show video **Input 02** across six displays as one large screen.
- ◆ The **Brown** Group will show video **Input 10** across six displays as one large screen with a section (video *Input 16*) of the viewing area missing.
- ◆ The **Yellow** Group will show video **Input 16** across two displays as one screen.
- ◆ The **Purple** and **Orange** Independent displays will show the video from their own video **Input 08 and 12**.

## Configuring Video Settings in Grid View

In a grid view, the audio and video outputs are assigned by mapping the audio/video input on the vertical axis to the audio/video output on a horizontal axis.

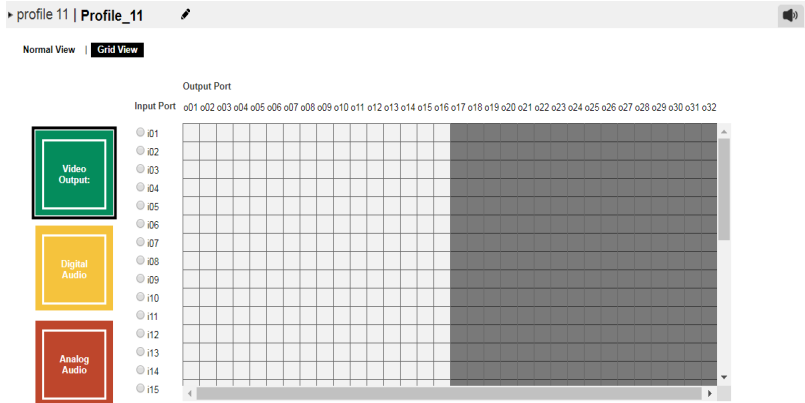

1. Click **Video Output**, **Digital Audio**, **Analog Audio** to select the type of settings.
2. Locate an input from the vertical axis and the output to which you wish from the horizontal axis, and then click the block in the grid where the input and output intercepts.

### Example 1

In the following illustration, input 01 is assigned to output 01, and input 02 to output 02, and so forth.

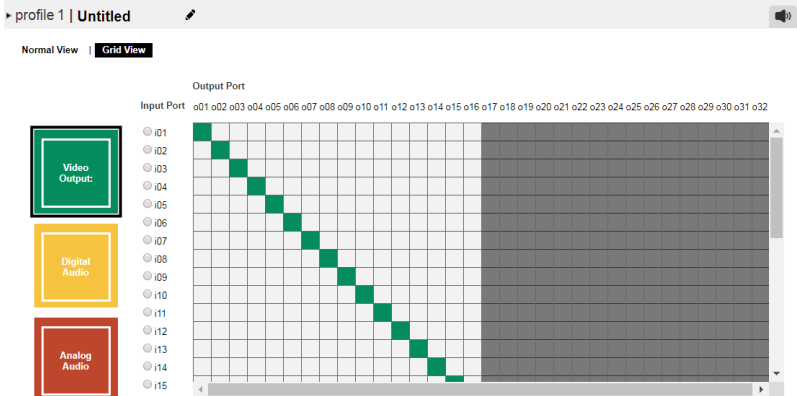

### Example 2

To assign the same input for all outputs, click the input from the vertical axis. In the following illustration, all output ports are assigned with input 01.

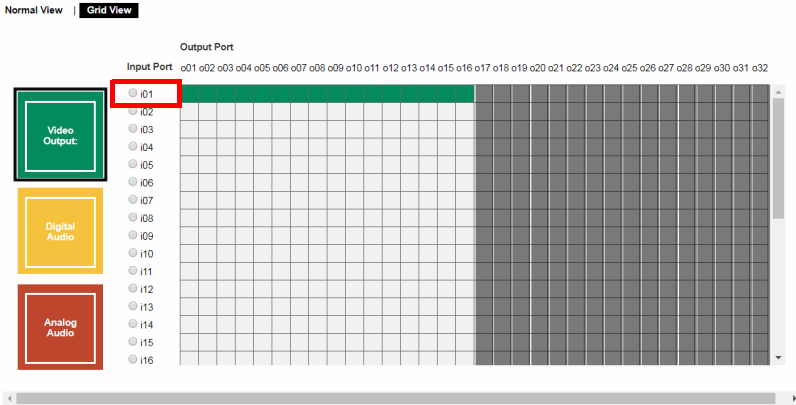

### Example 3

To have an audio output automatically switch to the audio input that comes along with the assigned video input, click **AFV** (audio following video). In this illustration, all digital audio output ports are set to follow their video input.

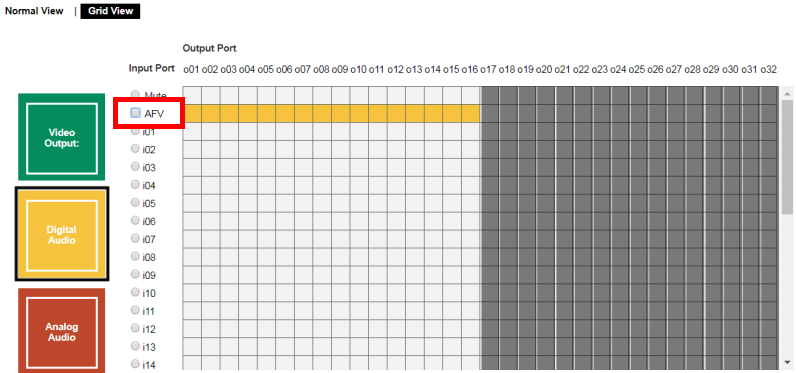

**Note:** To ensure synchronized video outputs on your video wall, configure the Hold Time setting of the VM3200 / VM3250 if you are using any VE805R / VE816R with the VM8514. For detailed information, please visit ATEN’s official website, go to Help Center (FAQ), and search for the information.

## Configuring Audio Output Settings

1. In the Profile List, locate the profile you wish to configure by clicking the zone tab.
2. Click the profile and then click **Edit**. This screen appears.

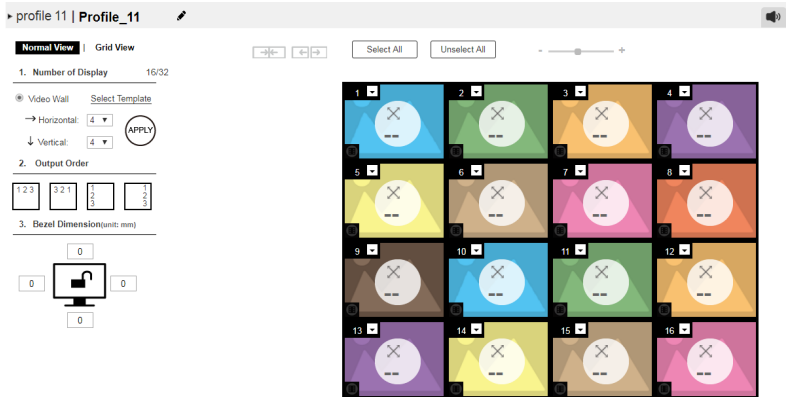

3. Click  from the top-right corner to switch to the audio settings page.

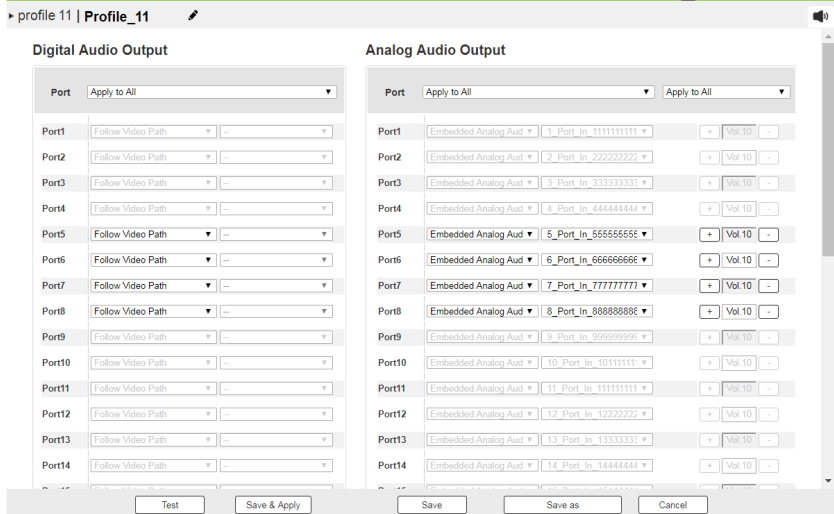

- ◆ **Digital Audio Output:** Use this column to assign audio inputs to the digital audio outputs.

- ◆ **Port:** Use this field to apply the same audio setting to all digital audio output ports.
  - ◆ **All ports follow video path:** Sets all digital audio outputs to receive the digital audio inputs that come with their video inputs as these videos display.
  - ◆ **All ports embedded analog audio:** Sets all digital audio outputs to receive a specified embedded analog audio input.
  - ◆ **All mute:** Mute all digital audio outputs.
- ◆ **Port 1 - Port 32:** Use these fields to assign different audio input for each digital audio output port.
  - ◆ **Follow video path:** Sets the digital audio output port to receive the digital audio input that comes with the video input as it displays.
  - ◆ **Embedded Analog Audio:** Sets the digital audio output port to receive the specified embedded analog audio input.
  - ◆ **Mute:** Mutes the digital audio output for the port.
- ◆ **Analog Audio Output:** Use this column to assign audio inputs to the analog audio output ports.
- ◆ **Port:** Use this field to apply the same audio setting to all analog audio output ports.
  - ◆ **All ports follow video path:** Sets all analog audio outputs to receive the digital audio inputs that come with their video inputs as these videos display.
  - ◆ **All ports embedded analog audio:** Sets all analog audio outputs to receive a specified embedded analog audio input.
  - ◆ **All ports embedded digital audio:** Sets all analog audio outputs to receive a specified digital audio input.
  - ◆ **All mute:** Mute all analog audio outputs.
- ◆ **Port 1 - Port 32:** Use these fields to assign different audio input for each digital audio output port.
  - ◆ **Follow video path:** Sets the analog audio output port to receive the digital audio input that comes with the video input as it displays.
  - ◆ **Embedded analog audio:** Sets the analog audio output port to receive a specified embedded analog audio input.
  - ◆ **Embedded digital audio:** Sets the analog audio output port to receive a specified digital audio input.
  - ◆ **Mute:** Mute the analog audio output port.



---

## Playing a Profile

### Apply Multiple Profiles by Batch

1. In the Profile List page, click the **Apply by Batch** button (top-right corner). This dialog box appears.

**Apply by Batch**

**Zone A:Main**  
P01:Profile\_01 ▼

**Zone B:Left**  
P05:Profile\_05 ▼

**Zone C: Right**  
Select profile ▼

**Zone D:Back**  
Select profile ▼

Apply Cancel

2. Use the drop-down menus to select the profile for each display zone and click **Apply**.

## Apply A Single Profile

1. In the Profile List, locate the profile you wish to play by clicking the zone tab.
2. Click the profile and then click **Apply**.

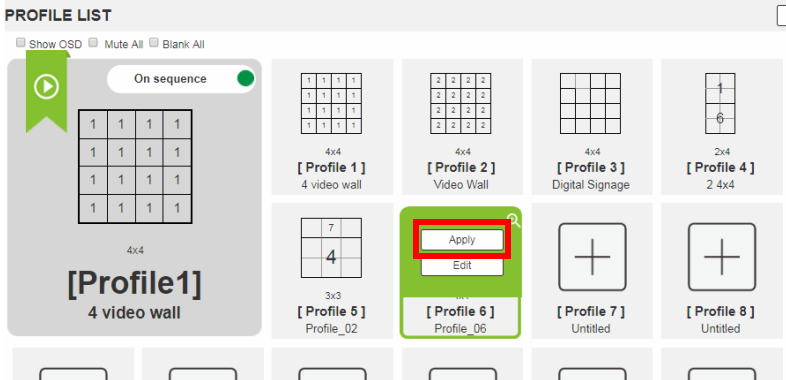

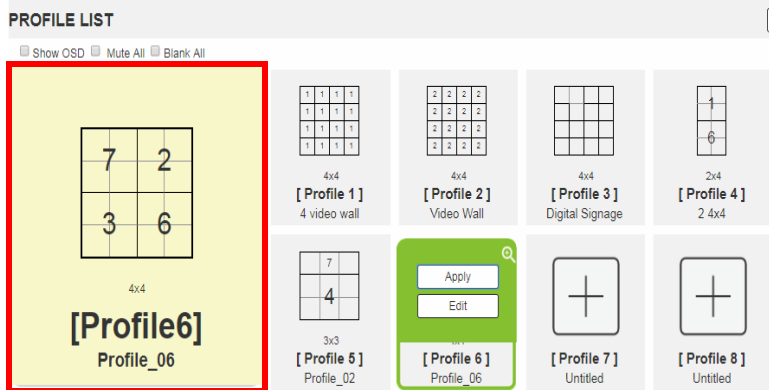

3. The profile is immediately applied and appears in the large **Play** window.

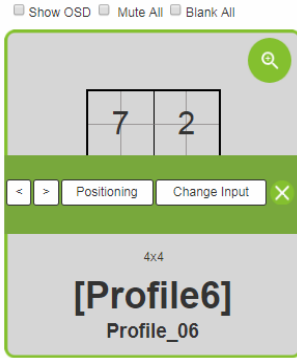

4. To adjust the played profile, click on the Play window. The following controls appear.



Option	Description
Show OSD	Check <b>Show OSD</b> to show the current connection status via OSD. When <b>Show OSD</b> is unchecked, the OSD will disappear.
Mute All	Check <b>Mute All</b> to mute the audio for all ports.
Blank All	Check <b>Blank All</b> to turn off the video to all displays.
	Click this icon to show a source assignment for this profile.
On Sequence	<b>On Sequence</b> appears when a profile schedule is playing.
<	Click < to go back to the previous profile in the sequence, when Profile Scheduling is in use. Only available with <i>On Sequence</i> .
>	Click > to advance to the next profile in the sequence, when Profile Scheduling is in use. Only available with <i>On Sequence</i> .
Positioning	Click <b>Positioning</b> to open a window that allows you to adjust the image position on each display. For Video Wall profiles, you can also set the Bezel Dimension, which is the frame thickness between each display.
Change Input	Click <b>Change Input</b> to change the input for single and grouped outputs, as explained on the next page.
	Click this icon to delete the profile.

## Change Input

The *Change Input* page gives you a preview of what's displayed on all screens, allows you to change the inputs and view a live stream of each input. To access this page, click **Change Input** from the Play Window (see *Change Input*, page 90).

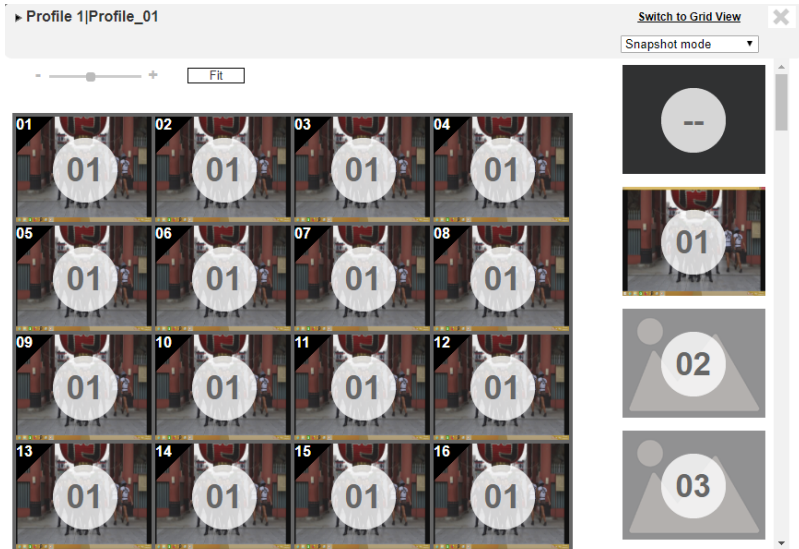





The *Change Input* page displays still image frames of output configuration, the left panel shows the profile's output configuration, and the right column lists the available inputs. The page provides the following options:

- ◆ To change the input of a display, **Drag and Drop** an input from the right column to any output in the left panel.
- ◆ Click **Switch to Grid View** to use the grid view to change the input and output connections. For details, see *Configuring Video Settings in Grid View*, page 83.
- ◆ Use the drop-down menu to show the input ports in **Snapshot** or **List mode**.
- ◆ Use the slide bar to zoom the layout in (+) or out (-). Click **Fit** to set the layout to the default view.
- ◆ Click any input in the right column to view a live stream of the video source.
- ◆ Click on the refresh icon,  to refresh the *Change Input* page.

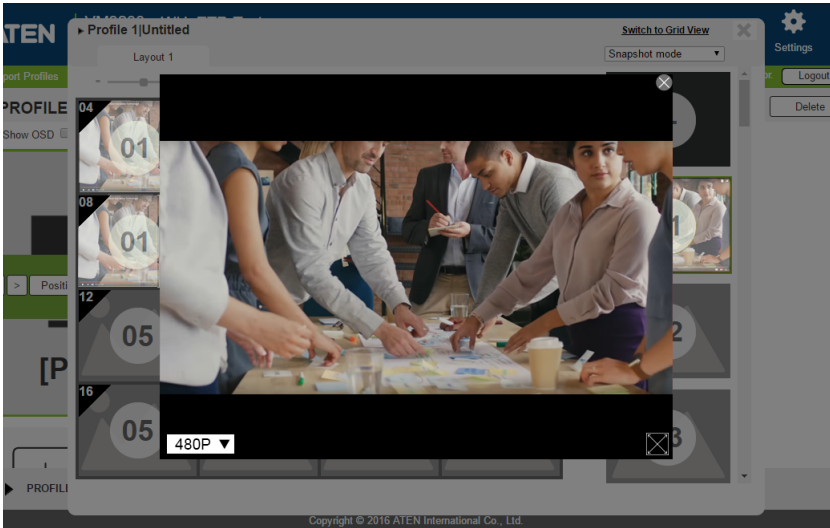
## Live Streaming View

This window gives you a live stream of the video source. To access this page, click an input from the right column on the *Change Input* page (see *Change Input*, page 90).

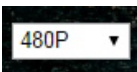

Option	Description
	Click the icon to increase / decrease the size of the live preview window.
	Click the drop down menu to change the resolution, the available resolutions are, 1080P / 720P / 480P.
	Click on the icon, to close the window.

## Exporting a Profile

To export the VM3200 / VM3250's connection profiles, click **Export Profiles** from the main screen. A configuration file starts downloading.

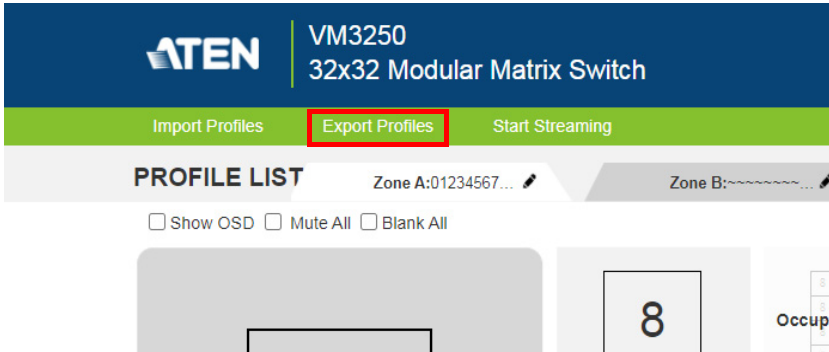

## Importing a Profile

To import connection profiles to the VM3200 / VM3250, do the following:

1. From the main screen, click **Import Profiles**.

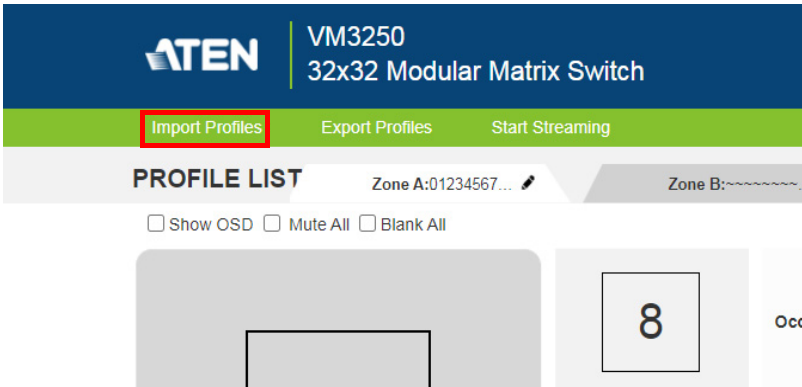

2. Browse to the configuration file, select it and click **Open**.

---

**Note:** Importing a connection profile database will overwrite the current profiles.

---

## Streaming Out Videos Live

---

You can stream out video sources live via the VM3250 to a video live streaming platform of your choice, such as YouTube or Twitch.

### Note:

- ◆ This is a VM3250-only feature.
  - ◆ The VM3250 currently streams videos only. For a source that contains both video and audio, only the video will be streamed.
- 

### Preparation

- ◆ Make sure your video source (e.g. camera or media player) is plugged in to an input board installed to the VM3250.
- ◆ Register for a video streaming service of your choice and obtain the RTMP server URL and steaming key. This information will be required when configuring the VM3250's streaming function.

### Configuration

1. Configure the streaming out settings.
  - a) From the VM3250's web interface, go to **Settings > General > Streaming Out**.

**Streaming Out**

Server URL	<input type="text" value="rtmp://live-tpe01.twitch.tv/app"/>
Streaming Key	<input type="text" value="....."/> <a href="#">Show</a>

- b) Enter the Server URL and Streaming Key.

2. Select a video source.

- a) Click  Profile List to switch to the Profile List page.

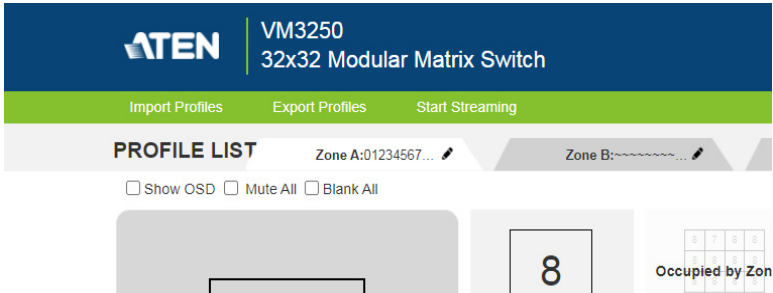

- b) From the green toolbar, click **Start Streaming**. This dialog box appears.

---

**Note:** To see previews of video sources, open the Change Input page. For details, see *Live Streaming View*, page 91.

---

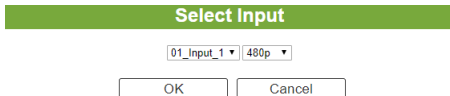

- c) Select an input source and a streaming resolution, and then click **OK**. This dialog box appears.

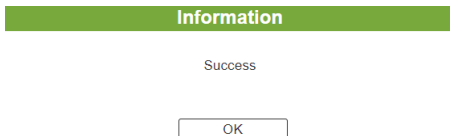



- Click **OK** to confirm the settings. A live icon appears in main screen to indicate that the selected input is being streamed out.

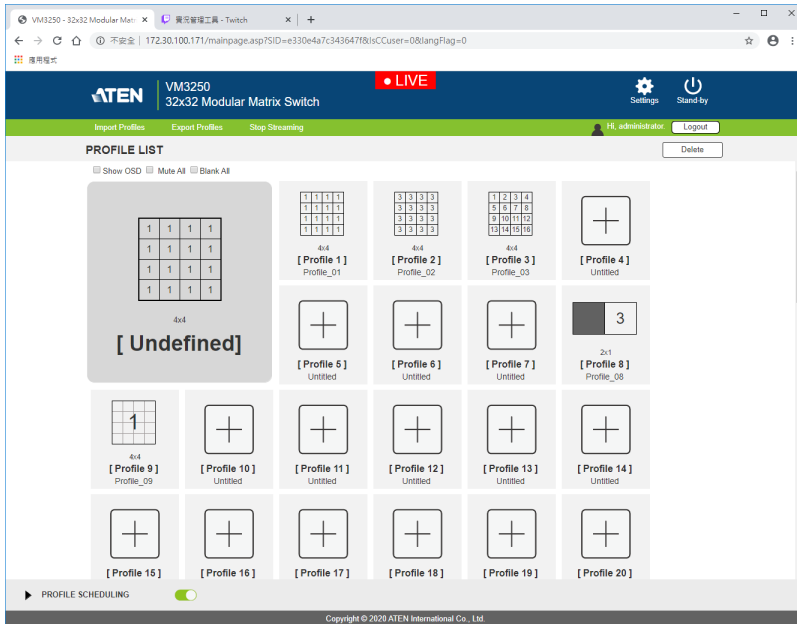

## Profile Scheduling

You can create one or more profile playlists that play periodically on specified time frames.

### Enabling/Disabling Profile Schedule

To have the Matrix Switch play profile playlists, follow the steps below.

1. Go to the Profile List page.
2. Configure profile playlists. For details, see *Adding Profile Playlists*, page 98.
3. From the Profile List page, click the **PROFILE SCHEDULING** toggle button to enable (green) or disable (gray) profile schedules.

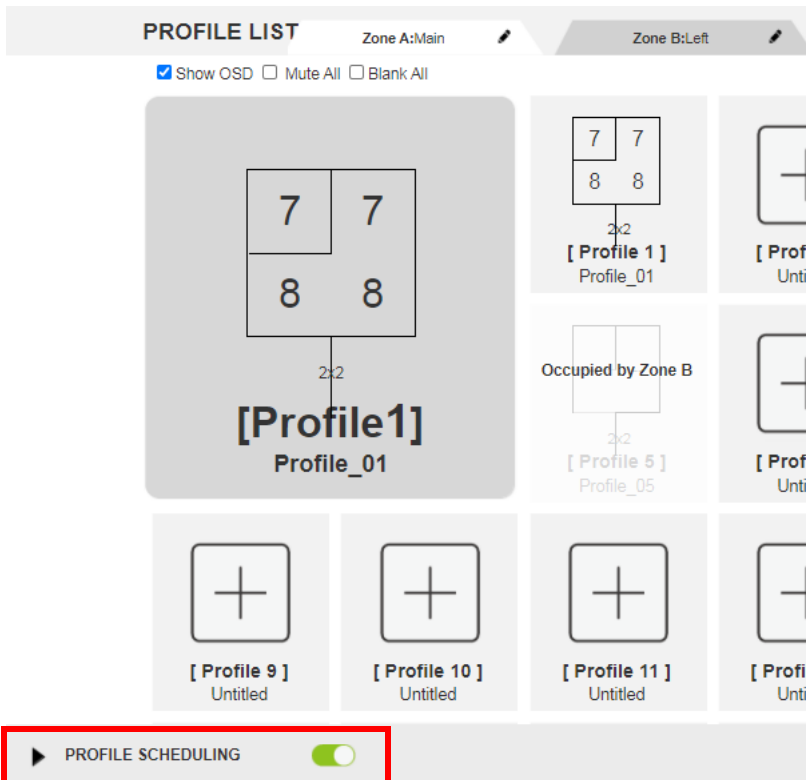

**Note:**

- ◆ For VM3200 using firmware prior to version 1.4.138, if profile scheduling is disabled and re-enabled within the scheduled time frame of a playlist, the VM3200 will resume playing the first profile in the playlist
  - ◆ For VM3250 or VM3200 using firmware version 1.4.138 or later, if profile scheduling is disabled and re-enabled within the scheduled time frame of a playlist, the system will resume playing the playlist according to schedule, and the profiles that were to be played during the paused period will be skipped.
-

## Adding Profile Playlists

### Adding a Recurring Playlist

To add a playlist that plays periodically, follow the steps below.

1. From the Profile List page, click **PROFILE SCHEDULING**. The profile calendar appears.

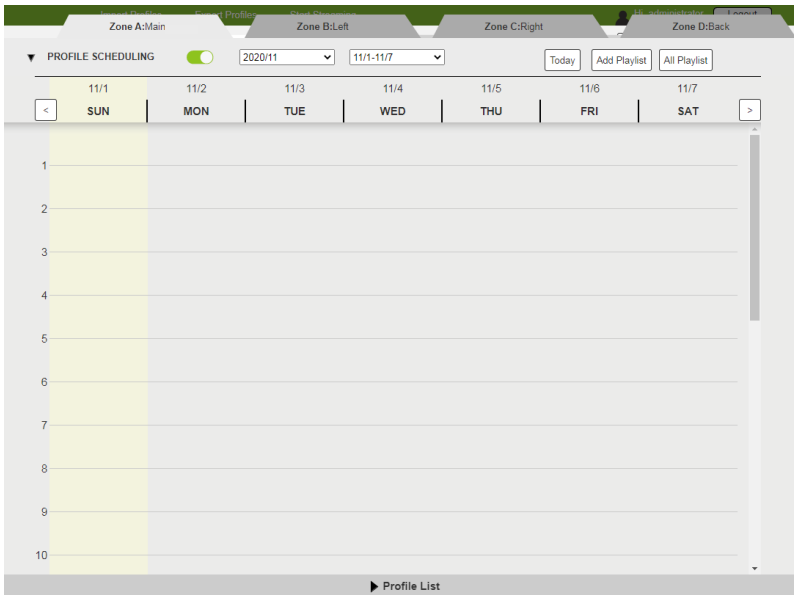

2. Click the display zone tab to select a display zone to which you wish to add a playlist.
3. Click the **Add Playlist** button or a day on the calendar to add a playlist. The Add Playlist window appears.

**Tip:** Use the   drop-down lists or the   buttons from the top to adjust the calendar view.

## 4. Configure the playlist.

**Add Playlist**
✕

Name:   All Day

Start Time:     :

End Time:     :

Frequency:



- a) Configure the Name, Start Time, End time, and Frequency.
- b) Click  to open the Select Profiles window. Click one or more profiles to add to the playlist.

Select profiles to add
4 / 20 ✕



4x4  
[ Profile 1 ]  
Profile\_01



8x4  
[ Profile 2 ]  
Profile\_02



4x4  
[ Profile 3 ]  
Profile\_03



4x4  
[ Profile 4 ]  
Profile\_04



4x4  
[ Profile 5 ]  
Profile\_05



4x4  
[ Profile 6 ]  
Profile\_06



4x4  
[ Profile 7 ]  
Profile\_07



4x4  
[ Profile 8 ]  
Profile\_08

c) Click **OK**. The selected profiles are added to the playlist. The profiles will be played from left to right.

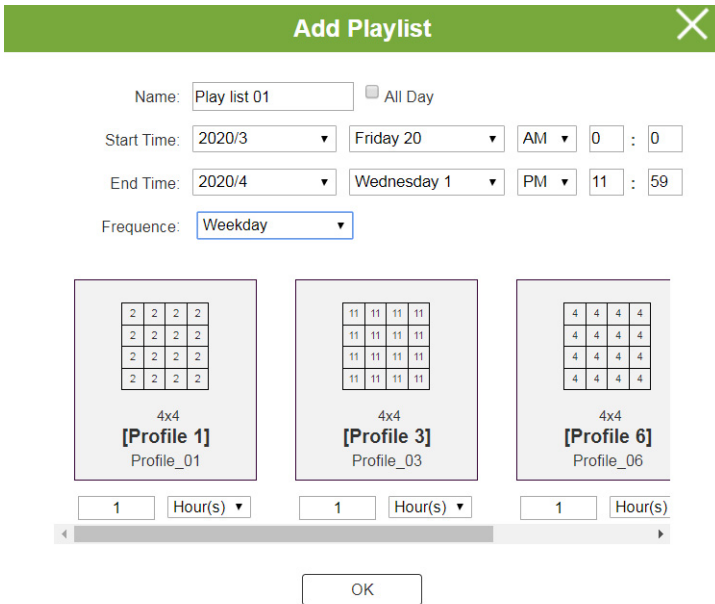

Adjust the play duration and the order of the added profiles if required. See the table below for more details.

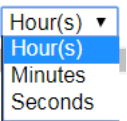
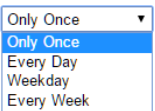
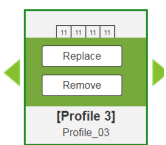
Option	Description
	<p>Use the drop-down menu to select <b>Hour(s)</b>, <b>Minutes</b>, or <b>Seconds</b> and then enter a duration (1-999) for the profile to play.</p> <p><b>Note:</b> When the the schedule switches to the next profile in the list.</p>
	<p>Use the drop-down menu to select <b>Only Once</b>, <b>Every Day</b>, <b>Weekday</b> or <b>Every Week</b> and then enter a duration (1-999) for the profile to play. After the time expires, the schedule switches to the next profile in the list.</p>
	<p>To replace, remove, or change the order of a profile, click on a profile to access the Replace, Remove, and the &lt; &gt; buttons.</p>

## Adding a One-off Profile Playlist

To add a playlist that plays once, follow the steps below.

1. From the Profile List page, click **PROFILE SCHEDULING**. The profile calendar appears.

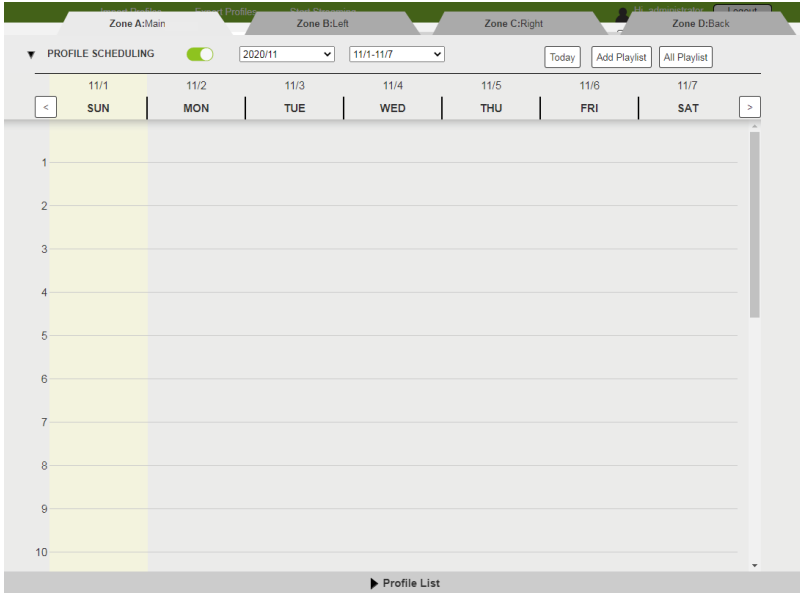

2. Click the display zone tab to select a display zone to which you wish to add a playlist.
3. Use the   buttons to adjust the calendar to a time frame to which you wish to add profiles.

4. Click **Profile List** at the bottom of the page. The Profile List appears.

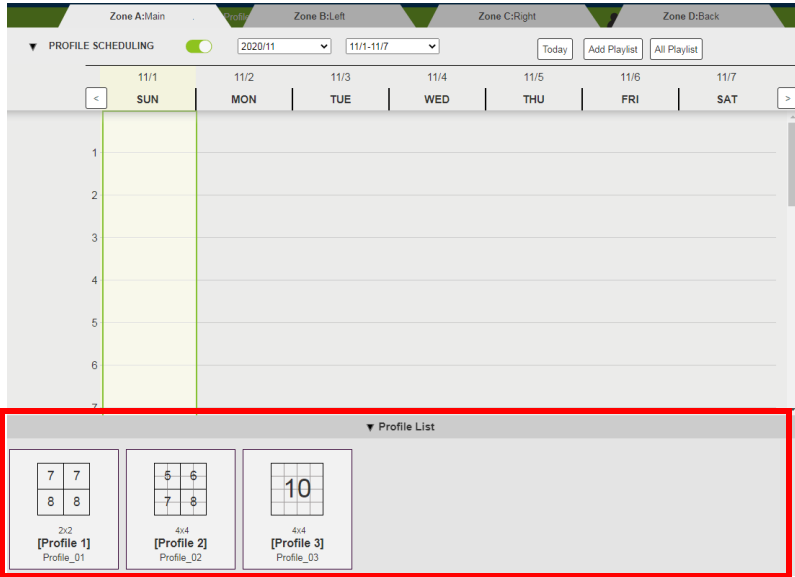



5. From the Profile List, drag and drop profiles onto the desired time on the calendar view. Optionally right-click the profile to copy, remove, or view its settings.





## Editing, Removing, or Copying Profile Playlists

To edit, remove, or copy profile playlists:

1. Locate the playlist by clicking the zone tab.
2. Click the  button from the Profile List page to open the All Playlist window.

All Playlist <span style="float: right;">✕</span>					
Name	Sequence	Start Time	End Time	Frequency	
Play List	04	2020/01/01 AM09:06	2020/01/01 AM10:06	Only Once	<input type="button" value="Add Playlist"/>   
Play List	03	2019/12/30 AM01:54	2019/12/30 AM02:54	Only Once	
Play List	04	2019/01/04 AM03:01	2019/01/05 AM02:50	Only Once	
Play List	04	2019/12/31 AM01:26	2019/12/31 AM02:26	Only Once	
Play List	04	2019/01/02 AM01:21	2019/01/02 AM03:21	Only Once	
Play List	03	2019/01/06 AM00:54	2019/01/06 AM01:54	Only Once	
Play List	05	2018/02/01 AM03:50	2018/02/01 AM04:50	Only Once	
Play List	07	2018/02/01 AM05:55	2018/02/01 AM06:55	Only Once	
Play List	08	2018/02/02 AM05:33	2018/02/02 AM06:33	Only Once	

3. Move the cursor to a playlist you want to edit, copy, or remove.
4. Click one of the following buttons.

Control	Description
<input type="button" value="Add Playlist"/>	Click to add a new profile playlist.
 View / Edit	Click to edit or view the selected profile playlist.
 Copy	Click to create a copy of the selected profile playlist.
 Remove	Click to remove the selected profile playlist.

# System Settings

## Overview

The setting pages allow you to configure the VM3200 / VM3250's system settings.

General
Port Setting ▼
Status ▼
Channel ▼
Maintenance

### General

**Basic**







Device Name 
Language English ▼

**System Time**

Date(Y/M/D): 2020 / 02 / 12
Time: 18 : 34
[Edit](#)

**Fan status**

35<sup>°C</sup>

Fan Speed Auto ▼

**Power Status**

Power Board



Primary Power  
800 W(9%used)



Redundant Power  
0 W(0%used)



**Serial Settings**

Serial Port Mode RS422/RS485 ▼

Serial Port Address 01 ▼
Baud Rate 19200 ▼

**Streaming Out**

Server URL rtmp://live-tpe01.twitch.tv/app

Streaming Key .....[Show](#)

If your Web GUI is not showing these setting, click the **Settings** icon from the top-right corner in the web interface.

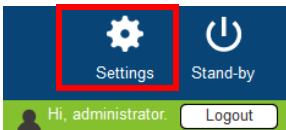

The table below provides an overview of the available settings for each tab.

Tab	Supported Functions	Detailed Information
General	<ul style="list-style-type: none"> <li>◆ Configure the device name.</li> <li>◆ Select the interface language.</li> <li>◆ Monitor the VM3200 / VM3250's fan temperature and configure the fan speed.</li> <li>◆ Monitor the system's power status.</li> <li>◆ Configure the settings for serial communications.</li> <li>◆ Configure settings for live streaming (only for VM3250).</li> </ul>	For more information, see <i>General</i> , page 107.
Port Settings	<ul style="list-style-type: none"> <li>◆ Configure the OSD and CEC port settings.</li> <li>◆ Configure the HDCP key for input and output ports.</li> <li>◆ Configure the Seamless Switch™ settings.</li> <li>◆ Name the input and output ports.</li> <li>◆ Select EDID modes.</li> </ul>	For more information, see <i>Port Settings</i> , page 109.
Status	<ul style="list-style-type: none"> <li>◆ View statuses of the input/output boards installed to the VM3200 / VM3250 and enable/disable FrameSynce and Long Reach mode for the board.</li> <li>◆ View system information such as network settings, firmware version, and the settings for audio/video assignment, volume, CEC, audio mode settings, and more.</li> </ul>	For more information, see <i>YCBCR 4:2:0 Video Data Block</i> , page 129.
Channel	<ul style="list-style-type: none"> <li>◆ Configure the IR routes for the input/output boards.</li> <li>◆ Configure the RS-232 serial communication routes for the input/output boards.</li> </ul> <p><b>Note:</b> The IR/RS-232 Channel settings are only supported by VM7514/VM7584 Input Board or VM8514/VM8584 Output Board.</p>	For more information, see <i>RS-232 Channel</i> , page 133.

Tab	Supported Functions	Detailed Information
Maintenance	<ul style="list-style-type: none"><li>◆ Upgrade the firmware for the installed input and output boards</li><li>◆ Back up or restore the VM3200 / VM3250's configuration</li><li>◆ Add, edit, or remove user accounts</li><li>◆ Configure the system network settings</li></ul>	See <i>Maintenance</i> , page 135.

---

## General

General
Port Setting ▼
Status ▼
Channel ▼
Maintenance

### General

**Basic**







Device Name 
Language English ▼

**System Time**

Date(Y/M/D): 2020 / 02 / 12
 Time: 18 : 34
[Edit](#)

**Fan status**

# 35<sup>°C</sup>

Fan Speed Auto ▼

**Power Status**

**Power Board**



OK

**Primary Power**  
800 W(9%used)



OK

**Redundant Power**  
0 W(0%used)



N/A

**Serial Settings**

Serial Port Mode RS422/RS485 ▼

Serial Port Address 01 ▼
Baud Rate 19200 ▼

**Streaming Out**

Server URL

Streaming Key  [Show](#)

### Basics

- ◆ **Device Name:** Type to name your Modular Matrix Switch.
- ◆ **Language:** Click to select a language for the web interface.

### System Time

Click **Edit** to configure the system date and time settings.

### Fan Status

- ◆ **Fan speed:** Click to select a fan speed.
- ◆ **Temperature and fan icons:** Indicates the internal temperature and status of the cooling fans. The fan icons rotate to indicate they are working.

**Note:** If the fans have stopped working or are switched off, they will appear as follows. The fan module will then need to be replaced or reset.



## Power Status

This section displays the status and percentage used of the Primary and Redundant Power units.

## Serial Settings

- ◆ **Serial Port Mode:** Defines the serial communications mode for the VM3200 / VM3250.
  - ◆ **RS-232 Configuration Mode:** Allows the user to configure VM3200 / VM3250's system via RS-232 serial commands.
  - ◆ **RS-232 Control Mode:** Allows the user to control remote devices that are connected to VM3200 / VM3250 through its RS-232 channels. To enable this feature, select the **RS232 Control Mode** and configure the input to output settings. For details, see *RS-232 Channel*, page 133.

---

**Note:** To enable this feature, make sure to also configure the RS-232 channeling. For details, see *RS-232 Channel*, page 133.

---

- ◆ **RS-422/RS-485:** If you are using **RS422/RS485**, define the Serial Port Address using the drop-down list.
- ◆ **Serial Port Address:** Defines the serial port address.
- ◆ **Baud rate:** Defines the baud rate for the serial port.

## Streaming Out

You can use the VM3250 to stream live videos out. For detailed information on setting up and stream out a video source, see

- ◆ **Server URL:** Enter the URL of the streaming server for which you have registered.
- ◆ **Streaming Key:** Enter the streaming key (provided by the server or platform you have registered).

## Port Settings

### OSD/CEC

The OSD/CEC page lets users view and set OSD and CEC settings for all ports.

#### OSD / CEC

Port	OSD	CEC
	Apply to All ▼	Apply to All ▼
1	<input checked="" type="checkbox"/> ON	<input type="checkbox"/> OFF
2	<input checked="" type="checkbox"/> ON	<input type="checkbox"/> OFF
3	<input checked="" type="checkbox"/> ON	<input type="checkbox"/> OFF
4	<input checked="" type="checkbox"/> ON	<input type="checkbox"/> OFF
5	<input checked="" type="checkbox"/> ON	<input type="checkbox"/> OFF
6	<input checked="" type="checkbox"/> ON	<input type="checkbox"/> OFF
7	<input checked="" type="checkbox"/> ON	<input type="checkbox"/> OFF
8	<input checked="" type="checkbox"/> ON	<input type="checkbox"/> OFF
9	<input checked="" type="checkbox"/> ON	<input type="checkbox"/> OFF
10	<input checked="" type="checkbox"/> ON	<input type="checkbox"/> OFF
11	<input checked="" type="checkbox"/> ON	<input type="checkbox"/> OFF
12	<input checked="" type="checkbox"/> ON	<input type="checkbox"/> OFF
13	<input checked="" type="checkbox"/> ON	<input type="checkbox"/> OFF
14	<input checked="" type="checkbox"/> ON	<input type="checkbox"/> OFF
15	<input checked="" type="checkbox"/> ON	<input type="checkbox"/> OFF
16	<input checked="" type="checkbox"/> ON	<input type="checkbox"/> OFF
17	<input checked="" type="checkbox"/> ON	<input type="checkbox"/> OFF
18	<input checked="" type="checkbox"/> ON	<input type="checkbox"/> OFF
19	<input checked="" type="checkbox"/> ON	<input type="checkbox"/> OFF
20	<input checked="" type="checkbox"/> ON	<input type="checkbox"/> OFF
21	<input checked="" type="checkbox"/> ON	<input type="checkbox"/> OFF
22	<input checked="" type="checkbox"/> ON	<input type="checkbox"/> OFF
23	<input checked="" type="checkbox"/> ON	<input type="checkbox"/> OFF
24	<input checked="" type="checkbox"/> ON	<input type="checkbox"/> OFF
25	<input checked="" type="checkbox"/> ON	<input type="checkbox"/> OFF
26	<input checked="" type="checkbox"/> ON	<input type="checkbox"/> OFF
27	<input checked="" type="checkbox"/> ON	<input type="checkbox"/> OFF
28	<input checked="" type="checkbox"/> ON	<input type="checkbox"/> OFF
29	<input checked="" type="checkbox"/> ON	<input type="checkbox"/> OFF
30	<input checked="" type="checkbox"/> ON	<input type="checkbox"/> OFF
31	<input checked="" type="checkbox"/> ON	<input type="checkbox"/> OFF
32	<input checked="" type="checkbox"/> ON	<input type="checkbox"/> OFF

\* The CEC setting is only for output boards, please make sure all devices have this capability.

- ◆ **OSD:** Sets the default OSD option for the port. When OSD is on, real-time text updates appear on the display for 10 seconds when configuration and port changes are made to its output.
  - ◆ Use the drop-down menu to apply options to all ports, or ON/OFF button to enable/disable the OSD for each port.
- ◆ **CEC:** Consumer Electronics Control (CEC) allows interconnected HDMI devices to communicate and respond to one remote control.
  - ◆ Use the drop-down menu to apply options to all ports, or On/Off button to enable/disable CEC for a port.



## HDCP

The *HDCP* page lets users view and set HDCP key settings between input and output ports for digital copy protection and to ensure Seamless Switch™ is used between different devices. This is an Administrator and Advanced User only function.

### HDCP Configuration

The screenshot displays the HDCP Configuration interface. It is divided into three main sections:

- Input:** A dropdown menu is set to "Apply to All". Below it are eight rows, each with a "Port" number (1-8) and a dropdown menu set to "All Ports HDCP 1.4".
- Connection:** A central diagram showing eight input ports on the left and eight output ports on the right. Lines connect each input port to its corresponding output port. A legend at the top right indicates that a green line represents the "Connection Path".
- Output:** A dropdown menu is set to "Apply to All". Below it are eight rows, each with a "Port" number (1-8) and a checkbox labeled "Fix HDCP", all of which are checked.

However, some input board does not support HDCP configuration, Please see the table below for a list of input boards that support HDCP configuration.

HDCP Supported Input Boards	Description
VM7814 / VM7824 / VM7904 / VM7854	Allows user to set HDCP settings between the input and output ports. <ul style="list-style-type: none"> <li>◆ All Ports HDCP 1.4</li> <li>◆ All Ports HDCP 2.2</li> <li>◆ All Ports Non-HDCP</li> </ul>

### Connection

Here users can find a visual display of connection paths between inputs and outputs. When selecting an input, its path is displayed in green.

### Output

Here users can define whether or not HDCP settings are fixed, either by individual port or by applying one setting to all ports. By prearranging and fixing keys, this setting ensures that Seamless Switch™ is possible even when switching between HDCP and non-HDCP enabled devices.

## Scaler

The Video settings page allows you to set Seamless Switch™ options which determine how a display performs when the Input port is changed.

Port	Seamless Switch	Transition	Period	Scale Resolution
	Apply to All	Apply to All	Apply to All	Apply to All
1	<input checked="" type="checkbox"/> ON	<input type="checkbox"/> OFF	---	1920x1080@60Hz
2	<input checked="" type="checkbox"/> ON	<input type="checkbox"/> OFF	---	1920x1080@60Hz
3	<input checked="" type="checkbox"/> ON	<input type="checkbox"/> OFF	---	1920x1080@60Hz
4	<input checked="" type="checkbox"/> ON	<input type="checkbox"/> OFF	---	1920x1080@60Hz
5	<input checked="" type="checkbox"/> ON	<input type="checkbox"/> OFF	---	1920x1080@60Hz
6	<input checked="" type="checkbox"/> ON	<input type="checkbox"/> OFF	---	1920x1080@60Hz
7	<input checked="" type="checkbox"/> ON	<input type="checkbox"/> OFF	---	1920x1080@60Hz
8	<input checked="" type="checkbox"/> ON	<input type="checkbox"/> OFF	---	1920x1080@60Hz
9	<input checked="" type="checkbox"/> ON	<input type="checkbox"/> OFF	---	1920x1080@60Hz
10	<input checked="" type="checkbox"/> ON	<input type="checkbox"/> OFF	---	1920x1080@60Hz
11	<input checked="" type="checkbox"/> ON	<input type="checkbox"/> OFF	---	1920x1080@60Hz
12	<input checked="" type="checkbox"/> ON	<input type="checkbox"/> OFF	---	1920x1080@60Hz
13	<input checked="" type="checkbox"/> ON	<input type="checkbox"/> OFF	---	1920x1080@60Hz
14	<input checked="" type="checkbox"/> ON	<input type="checkbox"/> OFF	---	1920x1080@60Hz
15	<input checked="" type="checkbox"/> ON	<input type="checkbox"/> OFF	---	1920x1080@60Hz
16	<input checked="" type="checkbox"/> ON	<input type="checkbox"/> OFF	---	1920x1080@60Hz
17	<input checked="" type="checkbox"/> ON	<input type="checkbox"/> OFF	---	1920x1080@60Hz
18	<input checked="" type="checkbox"/> ON	<input type="checkbox"/> OFF	---	1920x1080@60Hz
19	<input checked="" type="checkbox"/> ON	<input type="checkbox"/> OFF	---	1920x1080@60Hz
20	<input checked="" type="checkbox"/> ON	<input type="checkbox"/> OFF	---	1920x1080@60Hz
21	<input checked="" type="checkbox"/> ON	<input type="checkbox"/> OFF	---	1920x1080@60Hz
22	<input checked="" type="checkbox"/> ON	<input type="checkbox"/> OFF	---	1920x1080@60Hz
23	<input checked="" type="checkbox"/> ON	<input type="checkbox"/> OFF	---	1920x1080@60Hz
24	<input checked="" type="checkbox"/> ON	<input type="checkbox"/> OFF	---	1920x1080@60Hz
25	<input checked="" type="checkbox"/> ON	<input type="checkbox"/> OFF	---	1920x1080@60Hz
26	<input checked="" type="checkbox"/> ON	<input type="checkbox"/> OFF	---	1920x1080@60Hz
27	<input checked="" type="checkbox"/> ON	<input type="checkbox"/> OFF	---	1920x1080@60Hz

### Note:

When Seamless Switch™ is enabled:

- ◆ The *Transition*, *Period* and *Scale Resolution* options can be enabled.
- ◆ Video outputs will not display 3D, Deep Color, or interlace (i.e., 1080i) resolutions correctly. To use these features, first disable Seamless Switch™.
- ◆ Videos may not display within range (fit on the screen), in which case, make sure to adjust the display settings on your device.

Enable Seamless Switch™ to remove the video distortion and delay seen when an input port is switched. Use the drop-down menu to apply options to all ports, or the On/Off button to enable/disable Seamless Switch™ per port. With Seamless Switch™ enabled, the following options are made available:

- ◆ **Transition:** Allows you to fade the video display when the Input port is changed. Use the period option to set the fade speed.
  - ◆ Use the drop-down menu to apply options to all ports, or On/Off button to enable/disable Transition per port.
- ◆ **Period:** Sets the fade speed for the Transition option.
  - ◆ Use the drop-down menu to apply an option (*Slow*, *Normal*, or *Fast*) to all ports, or lower drop-down menus to apply options per port.
- ◆ **Scale Resolution:** Forces the port to scale the video displayed to the selected resolution.
  - ◆ Use the top drop-down menu to apply an option to all ports, or lower drop-down menus to apply options per port.

### Customized Resolution

Use the **Customized Resolution** to define an unique video resolution for your connected output boards. To set a customized resolution on your Seamless Switch™, follow the steps below.

**Note:** This function is only supported on output boards VM8814 / VM8824 / VM8514 with VE816R, and the supported resolutions may vary depending on the bandwidth and its limitation of the output boards.

1. Choose a port that you wish to define an unique video resolution to.

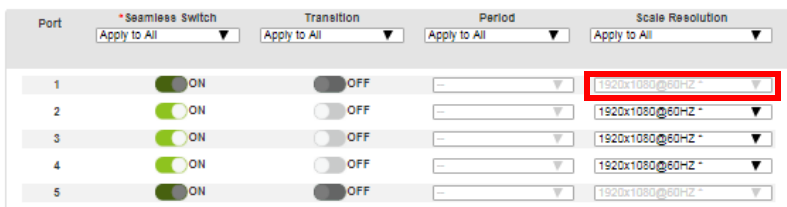

2. Use the drop-down menu and select **Customized**.

Scaler

Port	Seamless Switch	Transition	Period	Scale Resolution
1	<input checked="" type="checkbox"/> ON	<input type="checkbox"/> OFF	---	1920x1080@60HZ *
2	<input checked="" type="checkbox"/> ON	<input type="checkbox"/> OFF	---	1920x1200@60HZ
3	<input checked="" type="checkbox"/> ON	<input type="checkbox"/> OFF	---	2560x1080@60HZ
4	<input checked="" type="checkbox"/> ON	<input type="checkbox"/> OFF	---	3440x1440@50HZ
5	<input checked="" type="checkbox"/> ON	<input type="checkbox"/> OFF	---	3840x2160@24HZ
6	<input checked="" type="checkbox"/> ON	<input type="checkbox"/> OFF	---	3840x2160@25HZ
7	<input checked="" type="checkbox"/> ON	<input type="checkbox"/> OFF	---	3840x2160@30HZ
8	<input checked="" type="checkbox"/> ON	<input type="checkbox"/> OFF	---	3840x2160@50HZ 4.2.0
9	<input checked="" type="checkbox"/> ON	<input type="checkbox"/> OFF	---	3840x2160@50HZ 4.2.0
10	<input checked="" type="checkbox"/> ON	<input type="checkbox"/> OFF	---	4096x2160@24HZ
11	<input checked="" type="checkbox"/> ON	<input type="checkbox"/> OFF	---	4096x2160@25HZ
12	<input checked="" type="checkbox"/> ON	<input type="checkbox"/> OFF	---	4096x2160@30HZ
13	<input checked="" type="checkbox"/> ON	<input type="checkbox"/> OFF	---	4096x2160@50HZ 4.2.2
14	<input checked="" type="checkbox"/> ON	<input type="checkbox"/> OFF	---	4096x2160@50HZ 4.2.2
15	<input checked="" type="checkbox"/> ON	<input type="checkbox"/> OFF	---	4096x2160@60HZ
16	<input checked="" type="checkbox"/> ON	<input type="checkbox"/> OFF	---	4096x2160@60HZ
17	<input checked="" type="checkbox"/> ON	<input type="checkbox"/> OFF	---	4096x2160@60HZ

Copyright © 2021 ATEN International Co., Ltd.

3. Click **+Add New**.

Customized

No contents has been added.

**+Add New**

OK Cancel

- Define your resolutions and click **OK**. Click  to remove the customized resolution. To reduce blanking, check the Reduce Blanking checkbox.

Customized

**Customized-1**

x  @  Hz 

Reduce Blanking

---

+Add New

- Use the drop-down menu to select your pre-defined video resolution.

**Scaler**

Port	*Seamless Switch		Transition		Period		Scale Resolution	
	Apply to All		Apply to All		Apply to All		Apply to All	
1	ON	OFF					1920x1080@60HZ	
2	ON	OFF					2560x1080@50HZ	
3	ON	OFF					3440x1440@50HZ	
4	ON	OFF					3840x2160@24HZ	
5	ON	OFF					3840x2160@30HZ	
6	ON	OFF					3840x2160@50HZ 4.2.0	
7	ON	OFF					3840x2160@60HZ 4.2.0	
8	ON	OFF					4096x2160@24HZ	
9	ON	OFF					4096x2160@30HZ	
10	ON	OFF					4096x2160@50HZ 4.2.0	
11	ON	OFF					4096x2160@60HZ 4.2.0	
12	ON	OFF					3840x2160@50HZ	
13	ON	OFF					3840x2160@60HZ	
14	ON	OFF					4096x2160@50HZ	
15	ON	OFF					4096x2160@60HZ	
16	ON	OFF					3840x2160@24HZ 4.2.2 12bit	
17	ON	OFF					3840x2160@30HZ 4.2.2 12bit	
18	ON	OFF					3840x2160@50HZ 4.2.2 12bit	
							3840x2160@60HZ 4.2.2 12bit	
							4096x2160@24HZ 4.2.2 12bit	
							4096x2160@30HZ 4.2.2 12bit	
							4096x2160@50HZ 4.2.2 12bit	
							4096x2160@60HZ 4.2.2 12bit	
							1920x1080@60HZ *	
							1920x1080@60HZ *	
							1920x1080@60HZ *	
							1920x1080@60HZ *	

Copyright © 2021 ATEN International Co., Ltd.

## Port Name

The *Annotation* page lets users name the Input and Output ports for easy identification.

Please enter characters without using \*+/@=#:;'"<>?()\&

Input Port		Output Port	
1	<input type="text" value="1_Port_In_1"/>	1	<input type="text" value="1_Port_Out_1"/>
2	<input type="text" value="2_Port_In_2"/>	2	<input type="text" value="2_Port_Out_2"/>
3	<input type="text" value="3_Port_In_3"/>	3	<input type="text" value="3_Port_Out_3"/>
4	<input type="text" value="4_Port_In_4"/>	4	<input type="text" value="4_Port_Out_4"/>
5	<input type="text" value="5_Port_In_5"/>	5	<input type="text" value="5_Port_Out_5"/>
6	<input type="text" value="6_Port_In_6"/>	6	<input type="text" value="6_Port_Out_6"/>
7	<input type="text" value="7_Port_In_7"/>	7	<input type="text" value="7_Port_Out_7"/>
8	<input type="text" value="8_Port_In_8"/>	8	<input type="text" value="8_Port_Out_8"/>
9	<input type="text" value="9_Port_In_9"/>	9	<input type="text" value="9_Port_Out_9"/>
10	<input type="text" value="10_Port_In_10"/>	10	<input type="text" value="10_Port_Out_10"/>
11	<input type="text" value="11_Port_In_11"/>	11	<input type="text" value="11_Port_Out_11"/>
12	<input type="text" value="12_Port_In_12"/>	12	<input type="text" value="12_Port_Out_12"/>
13	<input type="text" value="13_Port_In_13"/>	13	<input type="text" value="13_Port_Out_13"/>
14	<input type="text" value="14_Port_In_14"/>	14	<input type="text" value="14_Port_Out_14"/>
15	<input type="text" value="15_Port_In_15"/>	15	<input type="text" value="15_Port_Out_15"/>
16	<input type="text" value="16_Port_In_16"/>	16	<input type="text" value="16_Port_Out_16"/>
17	<input type="text" value="17_Port_In_17"/>	17	<input type="text" value="17_Port_Out_17"/>
18	<input type="text" value="18_Port_In_18"/>	18	<input type="text" value="18_Port_Out_18"/>
19	<input type="text" value="19_Port_In_19"/>	19	<input type="text" value="19_Port_Out_19"/>
20	<input type="text" value="20_Port_In_20"/>	20	<input type="text" value="20_Port_Out_20"/>
21	<input type="text" value="21_Port_In_21"/>	21	<input type="text" value="21_Port_Out_21"/>
22	<input type="text" value="22_Port_In_22"/>	22	<input type="text" value="22_Port_Out_22"/>
23	<input type="text" value="23_Port_In_23"/>	23	<input type="text" value="23_Port_Out_23"/>
24	<input type="text" value="24_Port_In_24"/>	24	<input type="text" value="24_Port_Out_24"/>
25	<input type="text" value="25_Port_In_25"/>	25	<input type="text" value="25_Port_Out_25"/>
26	<input type="text" value="26_Port_In_26"/>	26	<input type="text" value="26_Port_Out_26"/>
27	<input type="text" value="27_Port_In_27"/>	27	<input type="text" value="27_Port_Out_27"/>
28	<input type="text" value="28_Port_In_28"/>	28	<input type="text" value="28_Port_Out_28"/>
29	<input type="text" value="29_Port_In_29"/>	29	<input type="text" value="29_Port_Out_29"/>
30	<input type="text" value="30_Port_In_30"/>	30	<input type="text" value="30_Port_Out_30"/>
31	<input type="text" value="31_Port_In_31"/>	31	<input type="text" value="31_Port_Out_31"/>
32	<input type="text" value="32_Port_In_32"/>	32	<input type="text" value="32_Port_Out_32"/>

- ♦ To name an Input/Output port, enter a descriptive name of up to 16 characters (including 0-9, a-z, A-Z, \_, -) in the corresponding field.
- ♦ To change an Input/Output port's name, enter another value and click **Save**.

---

**Note:** The Input and Output port names can be the same.

---

## EDID Settings

The EDID Setting page lets users view and select an EDID Mode so that the VM3200 / VM3250 can use the best resolution for its displays.

**EDID Mode**

ATEN Default  
 Port1 Mode  
 Remix  
 **Customized**

Apply

Port EDID Status

- Port 1 Customized
- Port 2 Customized
- Port 3 Customized
- Port 4 Customized
- Port 5 Customized
- Port 6 Customized
- Port 7 Customized
- Port 8 Customized
- Port 9 Customized
- Port 10 Customized

**EDID & CEA Description**

EDID	
1. Vendor/Product Identification	Model ID: 0x0001
2. EDID Structure/Revision	Manufacturer ID: ATN
3. Basic Display/Feature	Serial Number: 0x0000275B
4. Color Characteristics	Manufacture Date: 2014 Week 23
5. Established Timings	Week of Manufacture: 23
6. Standard Timings	Year of Manufacture: 2014
7. Detail Timing/Display Description 1	
8. Detail Timing/Display Description 2	
9. Monitor Description	
10. Monitor Description	

CEA
1. Display Support
2. Video Data
3. Audio Data
4. Speaker Allocation
5. Vendor Specific Data
6. HDMI Forum Vendor Specific Block
7. YCBCR 4:2:0 Video Data Block
8. YCBCR 4:2:0 Capability Map Data Block

---

**Note:** The EDID Mode can also be selected via the Front Panel pushbuttons – see *Operation Mode*, page 56.

---

Extended Display Identification Data (EDID) is a data format that contains a display's basic information and is used to communicate with the video source/system.



## EDID Mode

In the left panel of the page, users can select a pre-configured EDID Mode using the **EDID Mode** radio buttons.

**EDID Mode**

ATEN Default  
 Port1 Mode  
 Remix  
 **Customized**

Apply

Port EDID Status

Port 1 Customized

Port 2 Customized

Port 3 Customized

Port 4 Customized

Port 5 Customized

Port 6 Customized

Port 7 Customized

Port 8 Customized

Port 9 Customized

Port 10 Customized

**EDID & CEA Description**

**EDID**

- Vendor/Product Identification
- EDID Structure/Revision
- Basic Display/Feature
- Color Characteristics
- Established Timings
- Standard Timings
- Detail Timing/Display Description 1
- Detail Timing/Display Description 2
- Monitor Description
- Monitor Description

**CEA**

- Display Support
- Video Data
- Audio Data
- Speaker Allocation
- Vendor Specific Data
- HDMI Forum Vendor Specific Block
- YCBCR 4:2:0 Video Data Block
- YCBCR 4:2:0 Capability Map Data Block

Model ID: 0x0001
Manufacturer ID: ATN
Serial Number: 0x0000275B
Manufacture Date: 2014 Week 23
Week of Manufacture: 23
Year of Manufacture: 2014

Select the EDID Mode to use and click **Apply**. The VM3200 / VM3250 uses the settings configured for that EDID mode.

Options are:

- ◆ **ATEN Default:** All ports' EDID is the same as the hardware default EDID.
- ◆ **Port 1 Mode:** All ports' EDID is the same as Port1's EDID.
- ◆ **Remix:** All ports' EDID uses the best display resolution.
- ◆ **Customized:** See Customized Mode, see page 118.

## EDID & CEA Description

The middle panel of the screen lets users view and configure the EDID or the CEA mode.

**EDID Mode**

ATEN Default  
 Port1 Mode  
 Remix  
 **Customized**

Apply

Port EDID Status

Port 1 Customized

Port 2 Customized

Port 3 Customized

Port 4 Customized

Port 5 Customized

Port 6 Customized

Port 7 Customized

Port 8 Customized

Port 9 Customized

Port 10 Customized

**EDID & CEA Description**

**EDID**

- Vendor/Product Identification
- EDID Structure/Revision
- Basic Display/Feature
- Color Characteristics
- Established Timings
- Standard Timings
- Detail Timing/Display Description 1
- Detail Timing/Display Description 2
- Monitor Description
- Monitor Description

**CEA**

- Display Support
- Video Data
- Audio Data
- Speaker Allocation
- Vendor Specific Data
- HDMI Forum Vendor Specific Block
- YCBCR 4:2:0 Video Data Block
- YCBCR 4:2:0 Capability Map Data Block

Model ID: 0x0001

Manufacturer ID: ATN

Serial Number: 0x0000275B

Manufacture Date: 2014 Week 23

Week of Manufacture: 23

Year of Manufacture: 2014

- ◆ From the middle column, click the option that you want to view and/or edit. There are two categories: **EDID** (Extended Display Identification Data) and **CEA** (Consumer Electronics Association).
- ◆ When you select the menu items on the middle column, the current settings for the selected EDID appear on the right column. Some of the screens are read-only.
- ◆ For more information, see *EDID Settings*, page 118.

## Customized Mode

Use the **Customized** mode to automatically retrieve and save the EDID of a connected monitor/display device to an input source port.

The screenshot shows a web interface for configuring EDID and CEA settings. On the left, under 'EDID Mode', the 'Customized' radio button is selected. Below it, the 'Port EDID Status' section lists ports 1 through 10, each with a 'Customized' status. A green arrow points to 'Port 2 Customized'. On the right, the 'EDID & CEA Description' section displays a list of 10 EDID items and 8 CEA items. A red box highlights the 'Retrieve EDID' button at the top right and the 'Channel Configuration: 2.0 Display: Front Left/Right' text in the EDID list.

- ◆ In the left panel, select **Customized** from the EDID Mode section and click **Apply**.
- ◆ **Port EDID Status:** Select the input source port to which you want to store the EDID configuration.
- ◆ **Retrieve EDID:** Click this button to retrieve the EDID of a selected port. Select a port using the pop-up screen.

### Caution

Select a port to retrieve.

The dialog box contains two dropdown menus. The first dropdown is set to 'Customized' and the second is set to 'Customized EDID 01'. Below the dropdowns are 'OK' and 'Cancel' buttons.

- ◆ The right panel displays a summary of the acquired EDID settings that you can edit. Click **Save** and select the configuration for the **Current Port** or **All Ports** for the duration of the session.

### Save

Save changes to the current port or all ports?

The dialog box contains three buttons: 'Current', 'All Ports', and 'Cancel'.

## Customized EDID Parameters

The EDID structure is comprised of 128 bytes in total – each heading shown in the left column corresponds to a specific number of bytes.

The pages for the pre-configured EDID Modes (Port 1, Default and Remix) cannot be edited. The pages for the Customized EDID, which can be edited, are discussed in the proceeding sections:

## Established Timings

This page lists video resolutions/timings that display devices can support.

The screenshot shows the EDID configuration interface. On the left, under 'EDID Mode', 'Customized' is selected. The main area is titled 'EDID & CEA Description'. Under 'EDID', 'Established Timings' is selected. A red box highlights the following list of resolutions and refresh rates:

<input checked="" type="checkbox"/>	720x400 @ 70Hz
<input type="checkbox"/>	720x400 @ 88Hz
<input checked="" type="checkbox"/>	640x480 @ 60Hz
<input checked="" type="checkbox"/>	640x480 @ 67Hz
<input checked="" type="checkbox"/>	640x480 @ 72Hz
<input checked="" type="checkbox"/>	640x480 @ 75Hz
<input checked="" type="checkbox"/>	800x600 @ 56Hz
<input checked="" type="checkbox"/>	800x600 @ 60Hz
<input checked="" type="checkbox"/>	800x600 @ 72Hz
<input checked="" type="checkbox"/>	800x600 @ 75Hz
<input type="checkbox"/>	832x624 @ 75Hz (Apple Macintosh II)
<input type="checkbox"/>	1024x768 @ 87Hz, interlaced(1024*768i)
<input checked="" type="checkbox"/>	1024x768 @ 60Hz
<input checked="" type="checkbox"/>	1024x768 @ 70Hz
<input checked="" type="checkbox"/>	1024x768 @ 75Hz
<input checked="" type="checkbox"/>	1280x1024 @ 75Hz
<input type="checkbox"/>	1152x870 @ 75Hz(Apple Macintosh II)

At the bottom of the list are 'Clear' and 'Select All' buttons. The 'Save' button is located at the top right of the interface.

- ◆ Select the resolution(s) you want to use for the attached monitor/display device.
- ◆ Click **Clear All** to unselect all the items.
- ◆ Click **Select All** to check all the items.
- ◆ Click **Save** to apply the changes.

## Standard Timings

This page shows eight resolutions/timings that display devices can support in addition to those listed in the Established Timings page.

**EDID Mode**

ATEN Default  
 Port1 Mode  
 Remix  
 **Customized**

Apply

Port EDID Status

Port 1 Customized

Port 2 Customized

Port 3 Customized

Port 4 Customized

**EDID & CEA Description**

Retrieve EDID Save

**EDID**

- Vendor/Product Identification
- EDID Structure/Revision
- Basic Display/Feature
- Color Characteristics
- Established Timings
- Standard Timings
- Detail Timing/Display Description 1
- Detail Timing/Display Description 2
- Monitor Description

**CEA**

- Display Support
- Video Data
- Audio Data
- Speaker Allocation

H Active Pixel	V Active Pixel	R Refresh Rate	Aspect Ratio
H 1600	V 1200	R 60	4:3
H 1280	V 1024	R 60	5:4
H 1400	V 1050	R 60	4:3
H 1440	V 900	R 60	16:10
H 1680	V 1050	R 60	16:10
H 1920	V 1080	R 60	16:9
H 1280	V 800	R 60	16:10
H 1920	V 1200	R 60	16:10

- ◆ Select the *H Active Pixel* from the drop-down menu.
- ◆ Select the *Aspect Ratio* from the drop-down menu.
- ◆ Click **Save** to apply the changes.

## Detail Timing / Display Description

This screen gives more video resolution options, and provides resolution/timing details.

**EDID Mode**

ATEN Default  
 Port1 Mode  
 Remix  
 **Customized**

Apply

Port EDID Status

Port 1 Customized

Port 2 Customized

Port 3 Customized

Port 4 Customized

Port 5 Customized

**EDID & CEA Description**

Retrieve EDID Save

**EDID**

- Vendor/Product Identification
- EDID Structure/Revision
- Basic Display/Feature
- Color Characteristics
- Established Timings
- Standard Timings
- Detail Timing/Display Description 1
- Detail Timing/Display Description 2
- Monitor Description

**CEA**

- Display Support
- Video Data
- Audio Data
- Speaker Allocation

Resolution:

Pixel Clock(MHz): 148.50

**Stereo Display**

Interlaced: Non-Interlaced

Stereo Mode: none

Sync type: Digital Separate

Positive Vsync Polarity: yes

Positive Hsync Polarity: yes

**Resolution Detail**

	Horizontal	Vertical
Image Size :	mm	mm
Active PXL :	pixel	lines
Blanking Time :	pixel	lines
Sync Offset :	pixel	lines
Sync Width :	pixel	lines
Border :	pixel	lines

In the drop down menu, choose a resolution with values that fit the attached monitor/display device and click **Save**.

## Monitor Description

This screen lets you specify the viewing specifications, namely horizontal and vertical scan ranges and pixel clock rate, of your monitor/display device.

**EDID Mode**

ATEN Default  
 Port1 Mode  
 Remix  
 Customized

Apply

Port EDID Status

- Port 1 Customized
- Port 2 Customized
- Port 3 Customized
- Port 4 Customized
- Port 5 Customized
- Port 6 Customized
- Port 7 Customized
- Port 8 Customized
- Port 9 Customized
- Port 10 Customized

**EDID & CEA Description**

	Minutes	Max
Horizontal Scan Range:	15	~ 102
Vertical Scan Range:	23	~ 121
Pixel Clock Rate: (MHz)	210	(10~2550)

**EDID**

1. Vendor/Product Identification
2. EDID Structure/Revision
3. Basic Display/Feature
4. Color Characteristics
5. Established Timings
6. Standard Timings
7. Detail Timing/Display Description 1
8. Detail Timing/Display Description 2
9. Monitor Description
10. Monitor Description

**CEA**

1. Display Support
2. Video Data
3. Audio Data
4. Speaker Allocation
5. Vendor Specific Data
6. HDMI Forum Vendor Specific Block
7. YCBCR 4:2:0 Video Data Block
8. YCBCR 4:2:0 Capability Map Data Block

Enter the values that correspond to your device and click **Save** to apply the changes.

## CEA Settings

CEA is an extension data of the EDID structure, which further extends the standard definitions of EDID to support advanced features of monitors/display devices.

### Display Support

This screen describes the display's basic digital components.

The screenshot shows a web-based configuration interface for EDID and CEA settings. On the left, under 'EDID Mode', there are radio buttons for 'ATEN Default', 'Port1 Mode', 'Remix', and 'Customized' (which is selected). Below these is an 'Apply' button and a 'Port EDID Status' section with a list of ports from Port 1 to Port 10, all labeled 'Customized'. Port 1 is highlighted in green. On the right, under 'EDID & CEA Description', there are two buttons: 'Retrieve EDID' and 'Save'. The 'EDID' section lists 10 items: 1. Vendor/Product Identification, 2. EDID Structure/Revision, 3. Basic Display/Feature, 4. Color Characteristics, 5. Established Timings, 6. Standard Timings, 7. Detail Timing/Display Description 1, 8. Detail Timing/Display Description 2, 9. Monitor Description, and 10. Monitor Description. To the right of this list, there are fields for 'Revision: 0x03', 'Underscan: no', and 'Basic Audio: yes'. Below these, the 'YCbCr' section is highlighted with a red box and contains two checked options: 'YCbCr444' and 'YCbCr422'. The 'CEA' section lists 8 items: 1. Display Support, 2. Video Data, 3. Audio Data, 4. Speaker Allocation, 5. Vendor Specific Data, 6. HDMI Forum Vendor Specific Block, 7. YCBCR 4:2:0 Video Data Block, and 8. YCBCR 4:2:0 Capability Map Data Block.

Select the YCbCr mode applicable to your display and click **Save**.

## Video Data

This screen lists additional video resolution/timing displays that may be supported by other devices, other than PC monitors (for example, 1080i).

EDID Mode

ATEN Default

Port1 Mode

Remix

Customized

Port EDID Status

- Port 1 Customized
- Port 2 Customized
- Port 3 Customized
- Port 4 Customized
- Port 5 Customized
- Port 6 Customized
- Port 7 Customized
- Port 8 Customized
- Port 9 Customized
- Port 10 Customized

EDID & CEA Description

**EDID**

1. Vendor/Product Identification
2. EDID Structure/Revision
3. Basic Display/Feature
4. Color Characteristics
5. Established Timings
6. Standard Timings
7. Detail Timing/Display Description 1
8. Detail Timing/Display Description 2
9. Monitor Description
10. Monitor Description

**CEA**

1. Display Support
2. Video Data
3. Audio Data
4. Speaker Allocation
5. Vendor Specific Data
6. HDMI Forum Vendor Specific Block
7. YCBCR 4:2:0 Video Data Block
8. YCBCR 4:2:0 Capability Map Data Block

Native : 1920 x 1080p @ 59.94/60Hz 16:9

Resolution:

Multiple selection(maximum 26)items

<input checked="" type="checkbox"/>	640 x 480p @ 59.94/60Hz 4:3
<input checked="" type="checkbox"/>	720 x 480p @ 59.94/60Hz 4:3
<input checked="" type="checkbox"/>	720 x 480p @ 59.94/60Hz 16:9
<input checked="" type="checkbox"/>	1280 x 720p @ 59.94/60Hz 16:9
<input checked="" type="checkbox"/>	1920 x 1080i @ 59.94/60Hz 16:9
<input type="checkbox"/>	720(1440) x 480i @ 59.94/60Hz 4:3
<input type="checkbox"/>	720(1440) x 480i @ 59.94/60Hz 16:9
<input type="checkbox"/>	720(1440) x 240p @ 59.94/60Hz 4:3

Data Block Size:20

- ◆ Select the native resolution of the attached display device.
- ◆ Select the resolutions that work with the attached monitor/display device.
- ◆ Click **Clear All** to deselect all the items.
- ◆ Click **Save** to apply the changes.

126



## Audio Data

This screen lets you select advanced audio configurations for your device.

The screenshot shows a web interface for configuring audio data. On the left, there is a sidebar with 'EDID Mode' options: ATEN Default, Port1 Mode, Remix, and Customized (selected). Below this is an 'Apply' button and a 'Port EDID Status' section with a list of ports from Port 1 to Port 10, all labeled 'Customized'. Port 1 is highlighted in green. The main area is titled 'EDID & CEA Description' and contains two sections: 'EDID' and 'CEA'. The 'EDID' section lists 10 items, with '3. Audio Data' selected. The 'CEA' section lists 8 items. On the right, there are two buttons: 'Retrieve EDID' and 'Save'. A red box highlights the 'Audio Format' dropdown menus, which are numbered 1 through 6. The first dropdown, 'Audio Format 1', is currently set to 'Linear PCM 2-channel'.

Use the drop down menu to select the **Audio Format** (1~6) applicable to your audio output device, and click **Save** to apply the changes.

## HDMI Forum Vendor Specific Block

This screen shows the display device's supported video parameters. Use the toggle button to enable or disable this function.

The screenshot shows the configuration interface for the HDMI Forum Vendor Specific Block. It includes a sidebar for selecting the EDID mode (Port 1 Customized is selected), a central pane for EDID and CEA descriptions, and a right-hand pane for configuring specific video parameters like 3D OSD Display, Dual View, Independent View, and various DC (Deep Color) options. A 'Save' button is present to apply changes.

- ◆ **3D OSD Disparity:** Select this option to have Sink support receiving 3D OSD Disparity Indication in the HF-VSIF.
- ◆ **Dual View:** Select this option to have Sink support receiving 3D Dual View in the HF-VSIF.
- ◆ **Independent View:** Select this option to have Sink support receiving 3D Independent View in the HF-VSIF.
- ◆ **LTE 340Msc Scramble:** Select this option to have Sink support scrambling for TMDs Character Rates at or below 340 Mscs.
- ◆ **RR Capable:** Select this option to have Sink initiate an SCDC Read Request.
- ◆ **SCDC Present:** Select this option to have Sink support SCDC functionality.
- ◆ **DC 30bit 420:** Select this option to have Sink support 10-bits/component Deep Color 4:2:0 Pixel Encoding.
- ◆ **DC 36bit 420:** Select this option to have Sink support 12-bits/component Deep Color 4:2:0 Pixel Encoding.
- ◆ **DC 48bit 420:** Select this option to have Sink support 16-bits/component Deep Color 4:2:0 Pixel Encoding.

Use the drop down menu to select the **Audio Format** (1~6) applicable to your audio output device, and click **Save** to apply the changes.

## YCBCR 4:2:0 Video Data Block

Use this page to configure a list of supported YCBCR 4:2:0 video resolutions and select one to be applied. Use the toggle button at the top-right to enable or disable this feature.

EDID & CEA Description

**EDID**

1. Vendor/Product Identification
2. EDID Structure/Revision
3. Basic Display/Feature
4. Color Characteristics
5. Established Timings
6. Standard Timings
7. Detail Timing/Display Description 1
8. Detail Timing/Display Description 2
9. Monitor Description
10. Monitor Description

**CEA**

1. Display Support
2. Video Data
3. Audio Data
4. Speaker Allocation
5. Vendor Specific Data
6. HDMI Forum Vendor Specific Block
7. YCBCR 4:2:0 Video Data Block
8. YCBCR 4:2:0 Capability Map Data Block

**YCBCR 4:2:0 Video Data Block**

Select

640 x 480p @ 60Hz 4:3
720 x 480p @ 60Hz 4:3
720 x 480p @ 60Hz 16:9
1280 x 720p @ 60Hz 16:9
1920 x 1080i @ 60Hz 16:9
720(1440) x 480i @ 60Hz 4:3
720(1440) x 480i @ 60Hz 16:9
720(1440) x 240p @ 60Hz 4:3
720(1440) x 240p @ 60Hz 16:9
2880 x 480i @ 60Hz 4:3
2880 x 480i @ 60Hz 16:9

Resolution: multi-selection under : 5

Native

Selected

<input type="checkbox"/> 3840x2160p @ 50Hz 16:9
<input type="checkbox"/> 3840x2160p @ 60Hz 16:9
<input type="checkbox"/> 4096x2160p @ 50Hz 256:135
<input type="checkbox"/> 4096x2160p @ 60Hz 256:135

Data Block size : 4

- ◆ To add a supported resolution, click an item in the Select column, and then click **Add**.
- ◆ Use the drop down menu **Native** to adjust the supported resolution of the display.

## YCBCR 4:2:0 Compatibility Map Data Block

Use this page to configure a list of supported video resolutions for YCBCR 4:2:0 Compatibility Map Data Block and select one to be applied. Use the toggle button at the top-right to enable or disable this feature.

**EDID & CEA Description**

**EDID**

1. Vendor/Product Identification
2. EDID Structure/Revision
3. Basic Display/Feature
4. Color Characteristics
5. Established Timings
6. Standard Timings
7. Detail Timing/Display Description 1
8. Detail Timing/Display Description 2
9. Monitor Description
10. Monitor Description

**CEA**

1. Display Support
2. Video Data
3. Audio Data
4. Speaker Allocation
5. Vendor Specific Data
6. HDMI Forum Vendor Specific Block
7. YCBCR 4:2:0 Video Data Block
8. YCBCR 4:2:0 Capability Map Data Block

Retrieve EDID
Save

**YCBCR 4:2:0 Video Data Block**

Select		
<input type="checkbox"/>	640x480p @ 60Hz 4:3	1 size
<input type="checkbox"/>	720x480p @ 60Hz 4:3	1 size
<input type="checkbox"/>	720x480p @ 60Hz 16:9	1 size
<input type="checkbox"/>	1280x720p @ 60Hz 16:9	1 size
<input type="checkbox"/>	1920x1080i @ 60Hz 16:9	1 size
<input type="checkbox"/>	720(1440)x480i @ 60Hz 4:3	1 size
<input type="checkbox"/>	720(1440)x480i @ 60Hz 16:9	1 size
<input type="checkbox"/>	720(1440)x240p @ 60Hz 16:9	1 size
<input type="checkbox"/>	720(1440)x240p @ 60Hz 4:3	2 size
<input type="checkbox"/>	2880x480i @ 60Hz 4:3	2 size
<input type="checkbox"/>	2880x480i @ 60Hz 16:9	2 size

Add
Remove

Clear All

Max size is : 0

Selected

Current size : 0

- ◆ To add a supported resolution, click an item in the Select column, and then click **Add**.
- ◆ Use the drop down menu **Native** to adjust the supported resolution of the display.

130

## Status

### Connections

The connections tab provides a status summary of the input/output boards installed to the VM3200 / VM3250 and the devices that are connected to the ports on the input/output boards. If the connected devices support FrameSync and Long Reach mode, you can also enable/disable the function on this page.

#### Connections

Device List	Model Name	FW Version	Temperature	Power Consumption	HDCP	Cable Quality	FrameSync	Long Reach Mode
Main Board - VM@2F	VM3200	v0.00.000	43°C	50W(Max)	--			
▼ Input Slot 1	VM8814	v0.00.000	43°C	50W(Max)	--			
▼ Port 1						Cable Quality Test		OFF
▼ Transmitter	VE801T	v0.00.000	--	--	--			
MacBook	ModelName	--	--	--	--			
▶ Port 2						Cable Quality Test		OFF
▶ Port 3						Cable Quality Test		OFF
▼ Port 4						Cable Quality Test		OFF
MacBook	ModelName	--	--	--	--			
▼ Output Slot 1	VM8814	v0.00.000	43°C	50W(Max)	--			
▶ Port 1						Cable Quality Test	OFF	OFF
▶ Port 2						Cable Quality Test	OFF	OFF
▶ Port 3						Cable Quality Test	OFF	OFF
▶ Port 4						Cable Quality Test	OFF	OFF

Use the Connections page to:

- ◆ Monitor input/output board temperatures.
- ◆ Find out about HDCP settings of the input/output boards
- ◆ Perform cable quality analysis by clicking the **Cable Quality Test** button.



#### Note:

- ◆ BER Test is only applicable to the following cable connections:
  - ◆ VM7814 with its source device
  - ◆ VE816R with VM8514
- ◆ To test the quality of the cable connecting the VM7814 input board and its source device, unplug the cable from the source device and plug it into the corresponding port on the VM8814 output board, and then click the **BER Test** button to start the test. For example, if a cable plugs into port 1 of a VM7814 board, the other end should be plugged into port 1 of the VM8814 board before you start the test.











- ◆ To test the quality of all the cables connected to the Modular Matrix Switch, click **BER Test** at the top-right corner of the page.
- ◆ Enable/disable FrameSync and/or Long Reach Mode

## System Information

Use this page to look up system settings, including system network settings, firmware version, video/audio input assignments, output audio volumes, CED/OSD settings, output resolutions, HDMI audio mode settings, and power statuses.

**Hint:** Click  to view details and  to refresh the system.

### System Info

System Network 		
IP Address	10.3.52.124	
Sub Mask	255.255.254.0	
Gateway	10.3.53.254	
MAC Address	00:10:74:AE:01:22	
IP Assign	Static IP	
<b>Mainboard info</b> 		
<b>Video Connection</b> 		
<b>Audio Connection</b> 		
<b>Volume</b> 		
<b>CEC</b> 		
<b>OSD</b> 		
<b>Output Resolution</b> 		
<b>HDMI Audio Mode</b> 		
<b>Plug Status</b> 		

## RS-232 Channel

The IR/RS-232 Channel page is used to configure the IR/RS-232 communication routes between the input and output ports.

**Note:** The IR/RS-232 pages are only supported by VM7514/VM7584 and VM8514/VM8584 boards.

RS232 Channel

--- Disable Path    ● RS232 Return Path    — Output to Input    — Input to Output    — both

In-Board

Port	TX	Local
1	<input type="checkbox"/>	<input type="checkbox"/>
2	<input type="checkbox"/>	<input type="checkbox"/>
3	<input type="checkbox"/>	<input type="checkbox"/>
4	<input type="checkbox"/>	<input type="checkbox"/>
5	<input type="checkbox"/>	<input type="checkbox"/>
6	<input type="checkbox"/>	<input type="checkbox"/>
7	<input type="checkbox"/>	<input type="checkbox"/>
8	<input type="checkbox"/>	<input type="checkbox"/>
9	<input type="checkbox"/>	<input type="checkbox"/>
10	<input type="checkbox"/>	<input type="checkbox"/>
11	<input type="checkbox"/>	<input type="checkbox"/>
12	<input type="checkbox"/>	<input type="checkbox"/>
13	<input type="checkbox"/>	<input type="checkbox"/>
14	<input type="checkbox"/>	<input type="checkbox"/>
15	<input type="checkbox"/>	<input type="checkbox"/>
16	<input type="checkbox"/>	<input type="checkbox"/>
17	<input type="checkbox"/>	<input type="checkbox"/>
18	<input type="checkbox"/>	<input type="checkbox"/>
19	<input type="checkbox"/>	<input type="checkbox"/>
20	<input type="checkbox"/>	<input type="checkbox"/>
21	<input type="checkbox"/>	<input type="checkbox"/>
22	<input type="checkbox"/>	<input type="checkbox"/>
23	<input type="checkbox"/>	<input type="checkbox"/>
24	<input type="checkbox"/>	<input type="checkbox"/>
25	<input type="checkbox"/>	<input type="checkbox"/>
26	<input type="checkbox"/>	<input type="checkbox"/>
27	<input type="checkbox"/>	<input type="checkbox"/>
28	<input type="checkbox"/>	<input type="checkbox"/>
29	<input type="checkbox"/>	<input type="checkbox"/>
30	<input type="checkbox"/>	<input type="checkbox"/>
31	<input type="checkbox"/>	<input type="checkbox"/>
32	<input type="checkbox"/>	<input type="checkbox"/>

Board:

Connection

Follow Video Path

Out-Board

Port	RX	Local
1	<input type="checkbox"/>	<input type="checkbox"/>
2	<input type="checkbox"/>	<input type="checkbox"/>
3	<input type="checkbox"/>	<input type="checkbox"/>
4	<input type="checkbox"/>	<input type="checkbox"/>
5	<input type="checkbox"/>	<input type="checkbox"/>
6	<input type="checkbox"/>	<input type="checkbox"/>
7	<input type="checkbox"/>	<input type="checkbox"/>
8	<input type="checkbox"/>	<input type="checkbox"/>
9	<input type="checkbox"/>	<input type="checkbox"/>
10	<input type="checkbox"/>	<input type="checkbox"/>
11	<input type="checkbox"/>	<input type="checkbox"/>
12	<input type="checkbox"/>	<input type="checkbox"/>
13	<input type="checkbox"/>	<input type="checkbox"/>
14	<input type="checkbox"/>	<input type="checkbox"/>
15	<input type="checkbox"/>	<input type="checkbox"/>
16	<input type="checkbox"/>	<input type="checkbox"/>
17	<input type="checkbox"/>	<input type="checkbox"/>
18	<input type="checkbox"/>	<input type="checkbox"/>
19	<input type="checkbox"/>	<input type="checkbox"/>
20	<input type="checkbox"/>	<input type="checkbox"/>
21	<input type="checkbox"/>	<input type="checkbox"/>
22	<input type="checkbox"/>	<input type="checkbox"/>
23	<input type="checkbox"/>	<input type="checkbox"/>
24	<input type="checkbox"/>	<input type="checkbox"/>
25	<input type="checkbox"/>	<input type="checkbox"/>
26	<input type="checkbox"/>	<input type="checkbox"/>
27	<input type="checkbox"/>	<input type="checkbox"/>
28	<input type="checkbox"/>	<input type="checkbox"/>
29	<input type="checkbox"/>	<input type="checkbox"/>
30	<input type="checkbox"/>	<input type="checkbox"/>
31	<input type="checkbox"/>	<input type="checkbox"/>
32	<input type="checkbox"/>	<input type="checkbox"/>

RS232 Command-line

HEX

- ◆ **In-Board:** Use this set of settings to configure the IR/RS-232 signals for each input port.
  - ◆ **Port 1 ~ Port 32:** Configure each input port to use the *Local IR/RS-232*, *Tx IR/RS-232*, or *Loopback* for IR/RS-232 signals.
  - ◆ **Board:**
    - ◆ **Broadcast (1-All):** Controls all the connected devices simultaneously.
    - ◆ **Manual:** Controls specified devices simultaneously. Click **Edit** to select devices.
- ◆ Use **Loopback** for the IR/RS-232 signals to be sent back to local source or local display device connected to the same port on the same I/O board. This allows you to use the IR/RS-232 connection to control devices locally. Loopback prevents the IR/RS-232 signals from being sent across the connection to another I/O board. The Loopback setting is useful when you use a VM8514/VM8584 board to extend displays but use a different board type (not VM7514/VM7584) for input devices and want to use the IR/RS-232 signals for local control.
- ◆ **RS-232 Command Line:** Use this setting to remotely control a connected device via RS-232 commands.
- ◆ **Connection:** Sets the connection path for the IR/RS-232 signals.
  - ◆ Use the drop-down menu to select *Follow Video Path* to have the IR/RS-232 signal use the same connection path as the profile settings.
  - ◆ Use the drop-down menu to select *Broadcast (1-All)* to broadcast the IR/RS-232 signal from one port to all ports. Use the drop-down menu that appears to select the port that broadcasts the IR/RS-232 signal.
- ◆ **Out-Board:** Use this set of settings to configure the IR/RS-232 signals for each output port.
  - ◆ **Port 1 ~ Port 32:** Configure each output port to use the *Local IR/RS-232*, *Rx IR/RS-232*, or *Loopback* setting for the IR/RS-232 signals.

---

**Note:** By default the RS-232 Return Path uses the lowest port number available for a connection. This setting can not be changed.

---



## Maintenance

### System Setup

You can use the System Setup page to do any of the following:

- ◆ Upgrade the VM3200 / VM3250's mainboard, its streaming board, and any installed I/O boards
- ◆ Back up or restore the VM3200 / VM3250's settings. Note that account settings cannot be backed up or restored.

### Firmware upgrade

Mainboard I/O Board

Select a firmware file to begin

---

Streaming Board

Select a firmware file to begin

### Backup / Restore

\*User accounts cannot be backed up or restored.

---

Select a restore file to begin

To upgrade the VM3200 / VM3250's firmware, do the following:

1. Download the firmware package from ATEN's official website.
2. In the VM3200 / VM3250 web interface, go to Maintenance > System Setup > Firmware Upgrade > Mainboard I/O Board, click **Browse** to locate the firmware upgrade package.
3. Click **Upgrade** to begin the upgrade.

---

**Note:** After updating the firmware, it's recommended that you clear your web browser's cache and then close and reopen the web browser. This will ensure the GUI refreshes and functions properly.

---

To upgrade the VM3200 / VM3250's streaming board, do the following:

1. Download the firmware package from ATEN's official website. Select the one that indicates "streaming board" in the file name.
2. In the VM3200 / VM3250 web interface, go to Maintenance > System Setup > Firmware Upgrade > Streaming Board, click **Browse** to locate the firmware upgrade package.
3. Click **Upgrade** to begin the upgrade.

To back up the VM3200 / VM3250's system settings, click **Backup**. A configuration file will then begin downloading.

To restore the VM3200 / VM3250's system settings, do the following:

1. Use the **Browse** button to locate the configuration file. Make sure you have the correct file saved on your PC.
2. Click **Restore** to begin the restoration procedure.

---

**Note:** User accounts cannot be backed up or restored.

---

To reset the VM3200 / VM3250 to its default settings, click the **reset to default** button on the far right.



## User Account

The *User Account* page lets you add, edit, or delete users and change the password for accessing the VM3200 / VM3250's GUI.

**Note:** This is an Administrator only function.

User Name	Level	Description
administrator	Administrator	Default_User
user_1	Basic User	User_Account

- ◆ **Add account** – Click the *Add account* button to add another user to the list. The VM3200 / VM3250 supports up to 32 users and up to 16 concurrent logins (see page 138 for more details).
- ◆ **Edit** – Click the *Edit* button to change user information. This option allows an Administrator to edit individual accounts.

User Name	Level	Description	
<a href="#">Edit</a> 111111	Administrator	111111	
<a href="#">Edit</a> 12345	Administrator		
<a href="#">Edit</a> administrator	Administrator	Default_user	

- ◆ **Edit** – Rename the user account, set the password, add a description, and set the user's permission level (see page 138 for more details).
- ◆ **Delete** – Removes the user account.



- ◆ The default username and password are: administrator/password.

## Add Account

Use the Add Account / Edit buttons to create a user account, set the user's password, add a description, and set the user's permission level (see *Permission Level*, page 139) when accessing the VM3200 / VM3250's GUI.

**Add account**

Username

Password

Confirm Password

Please enter 5-10 characters without \*+@=#[]+=/?\|) space &

Description

Permission Level  Administrator Open/Save Profiles, Manage users  
 Advanced User Open/Save Profiles  
 Basic User Open Profiles

- ◆ Fill in a username or edit an existing one.
- ◆ Enter a password and re-type the password to confirm.

---

**Note:** Usernames and passwords accept multi-lingual characters, and must be 5–16 alphanumeric characters (excluding ;=[]+=/?\|). Passwords are case sensitive. Usernames only support lower case letters.

---

- ◆ Add or edit the description for the user.
- ◆ Select the permission level that you want to grant the user (see *Permission Level*, page 139).
- ◆ Click **Create User** to save the data.
- ◆ Click **Cancel** to discard the changes and exit.
- ◆ If a user is logged into the VM3200 / VM3250's GUI, their user settings cannot be edited, and the fields in this screen are grayed out.

## Permission Level

At the bottom of the New/Edit User page is the permission section, which is used to set a user's permission level.

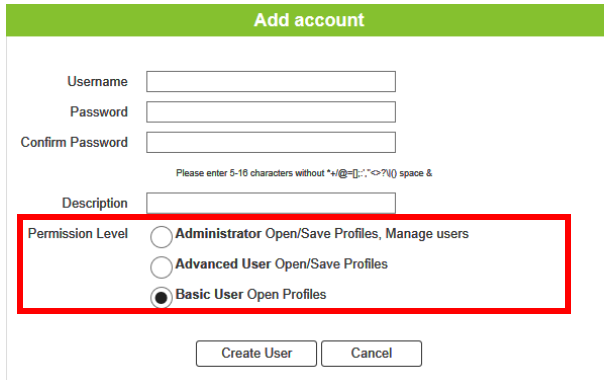

The screenshot shows a web form titled "Add account" with a green header. The form contains several input fields: "Username", "Password", "Confirm Password", and "Description". Below the "Description" field is a "Permission Level" section, which is highlighted with a red rectangular box. This section contains three radio button options: "Administrator Open/Save Profiles, Manage users", "Advanced User Open/Save Profiles", and "Basic User Open Profiles". The "Basic User" option is selected. At the bottom of the form are two buttons: "Create User" and "Cancel".

The three available permission levels are as follows:

- ♦ **Administrator** – this level provides full access and control of the VM3200 / VM3250, in addition to full User Management privileges.
- ♦ **Advanced User** – this level provides full access and control with no User Management privileges.
- ♦ **Basic User** – this level only provides basic functions (connections and open profiles).

## Network

The *Network* page lets you configure the VM3200 / VM3250's IP settings for connecting to it via the web GUI, and enable/disable Telnet.

DHCP	<input type="radio"/> Enable	<input checked="" type="radio"/> Disable
IP Address	<input type="text"/>	
Subnet Mask	<input type="text"/>	
Default Gateway	<input type="text"/>	
Website Timeout	5 min ▾	
MAC Address	00:10:74:AE:01:70	
Telnet	<input checked="" type="radio"/> Enable	<input type="radio"/> Disable

**Enable** DHCP to allow the DHCP server to assign an IP address to the VM3200 / VM3250. Select **Disable** to enter your own static IP address settings for the device.

Click **Reset** to use the following default values:

- ◆ IP Address – **192.168.0.60**
- ◆ Subnet Mask – **255.255.255.0**
- ◆ Default Gateway – **192.168.0.1**
- ◆ Website Timeout\* – N/A, 5, 10, 30, 60 minutes
- ◆ Telnet Configuration enabled (checked)

Enter the values, then click **Save**. Changes may take a few seconds and after refreshing the page automatically redirects you to the IP address specified.

---

\* This option controls how long an inactive web connection stays logged into the VM3200 / VM3250. Any changes will take effect immediately. The default setting is 5 minutes.

---

# Chapter 5

## CLI Commands

### Overview

---

The VM3200 / VM3250 can be configured and controlled via RS-232 or Telnet commands when connected to a host computer or other device, such as a control system. This chapter provides information on how to connect to the VM3200 / VM3250 via RS-232/Telnet and command syntax.

### Connecting to the Matrix Switch via Telnet

---

To establish a Telnet session with the VM3200 / VM3250, do the following:

1. Connect a host computer or control system to a shared network with the VM3200 / VM3250.
2. Open a command-line interpreter program from your computer.
3. In the command-line interpreter, type the VM3200 / VM3250's IP address in the following way:

```
telnet [IP address]:23
```

4. Press **Enter**. The login screen appears.
5. At the login prompt, type the login username and password for the VM3200 / VM3250.
6. When a session is established with the VM3200 / VM3250, you can control and configure the VM3200 / VM3250 via RS-232 commands. For more information on commands, see *Commands*, page 143.

---

**Note:** If a user logs in using a username that is already in session, the newest login takes effect and the previous session will be replaced.

---

## Connecting to the Matrix Switch via RS-232

You can control and operate the VM3200 / VM3250 using a high-end controller or PC. To connect to the VM3200 / VM3250 via RS-232, do the following:

1. Connect the RS-232 serial port on the VM3200 / VM3250 to the RS-232 serial port on your computer using a 9-wire straight cable, with only pin 2 to pin 2, pin 3 to pin 3, and pin 5 to pin 5 connected.

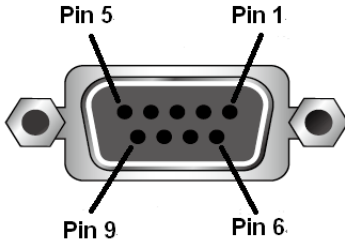

Pin	Description
1	Not connected
2	RXD
3	TXD
4	Not connected
5	GND
6	Not connected
7	Not connected
8	Not connected
9	Not connected

2. The controller's serial port should be configured as follows:

RS-232 Protocol	
Baud Rate	19200
Data Bits	8
Parity	None
Stop Bits	1
Flow Control	None

3. When a session is established with the VM3200 / VM3250, you can control and configure the VM3200 / VM3250 via RS-232 commands. For more information on commands, see *Commands*, page 143.



## Verification

---

After entering a command, a verification message appears at the end of the command line as follows:

- ◆ **Command OK** - indicates that the command is correct and successfully performed by the switch
- ◆ **Command incorrect** - indicates that the command has the wrong format and/or values.

## Commands

---

After connecting to the VM3200 / VM3250 via Telnet or RS-232, you can operate the system using the following commands.

### Switch Port Command

The formula for Switch commands is as follows:

**Switch Command + Input + Num1 + Output + Num2 + Address + Num3 + Stream + Control [Enter]**

1. For example, to switch input port 02 to output port 05, type the following:  
**sw i02 o05 [Enter]**
2. To switch output port 04 to the next port, input the following:  
**sw o04 + [Enter]**
3. To turn off video output on port 03, type the following:  
**sw o03 off [Enter]**
4. To turn off video output on port 03 on device 02, type the following:  
**sw o03 a02 off [Enter]**

The following tables show the possible values for the **Switch Port** command

Command	Description
sw	Switch command

Input	Description
i	Input port command

Num1	Description
xx	Input port xx: 01~32
*	All input ports

Output	Description
o	Output port command

Num2	Description
yy	Output port yy: 01~32
*	All output ports

Address	Description
a	Device address command (RS-422 and RS-485 only)

Num3	Description
zz	Device address zz: 01~16 (default is 01) (RS-422 and RS-485 only)
*	All devices

Stream	Description
video	Switch Video channel only
audio	Switch Stereo Audio channel only
all	Switch Video channel and Stereo Audio channel default select if been omitted

Control	Description
on	Turn on the display
off	Turn off the display
+	Next Port
-	Previous Port

---

**Note:** By default, input port 01 is tied to output port 01; input port 02 is tied to output port 02; and so on until port 08 (i.e., o01 i01, o02 i02... o16 i16)

---

The following table shows the available command list:

Command	Input	Input Port	Output	Output Port	Address	Device No.	Stream	Control	Enter	Description
sw	i	xx *	o	yy *	a	zz *	video audio all		[Enter]	Switch Input Port xx to Output Port yy on Address zz xx:01~32, * yy:01~32, * zz: 01~16, *
sw			o	yy *	a	zz *	video audio all	on off	[Enter]	Turn on Output Port yy Turn off Output Port yy on Address zz yy:01~32, * zz: 01~16, *
sw			o	yy *	a	zz *	video audio all	+ -	[Enter]	Switch Next Input to Output Port yy Switch Previous Input to Output Port yy yy:01~32 *

**Note:** 1. Each command string can be separated with a space.

2. The **Address** command is for RS-422/485 only. If the address parameter is missing from RS-422/485 commands, the default **a00** will be used. Skip the address for RS-232 commands.
3. The **Port Number** and **Address** command strings can be skipped, and the default value will be used.

## **Audio Commands**

Use audio commands to embed/de-embed inputs into a digital audio output or turn on/off an audio output. Note that these commands are only applicable when you have the required I/O boards installed to the matrix switch. For example, the VM7804 / VM7814 / VM7824 and the VM8804 / VM8814 / VM8824.

The formula for the audio command is as follows:

**Command + (Input + Num 1) + Output + Num3 + (Address + Device Num) + Num3 + Control + [Enter]**

Examples:

- ◆ To embed the analog audio from input port 2 to the stream at output port 1, type the following:  
**sw i02 o01 sido [Enter]**
- ◆ To de-embed the analog audio from a digital input at port 1 and assign the audio to the analog audio output at port 2, type the following:  
**sw i01 o02 diso [Enter]**
- ◆ To assign an analog audio input at port 2 to an analog audio output at port 1, type the following:  
**sw i02 o01 siso [Enter]**
- ◆ To turn off the analog audio at output port 1, type the following:  
**sw o01 audio off [Enter]**

The following tables show the possible values for the **audio** command:

<b>Command</b>	<b>Description</b>
sw	Switch command

<b>Output</b>	<b>Description</b>
o	Output port command

<b>Num1</b>	<b>Description</b>
xx	Output port number xx: 01~32 (default is 01)

Num1	Description
*	All output ports

Address	Description
a	Device address command (RS-422 and RS-485 only)

Num2	Description
zz	Device address zz: 01~16 (default is 01) (RS-422 and RS-485 only)
*	All devices

Control	Description	
side	Short for "stereo (audio) input digital (audio) output", this command is used to embed an analog audio into a digital output.	
diso	Short for "digital (audio) input analog audio output", this command is used to de-embed an audio input and assign it into an analog audio output.	
siso	Short for "stereo (audio) input stereo (audio) output", this command is used to assign an analog audio to an analog audio output.	
audio	on	Turn the specified audio output on.
	off	Turn the specified audio output off.

### Note:

- ◆ Each command string can be separated with a space.
- ◆ The **Address** command is for RS-422/485 only. If the address parameter is missing from RS-422/485 commands, the default **a00** will be used. Skip the address for RS-232 commands.

The following table shows the available command list:

Command	Input	Num1	Output	Num2	Address	Num3	Control	Enter	Description
sw	i	xx *	o	yy *	a	zz *	sido	[Enter]	Embed analog audio from input xx to digital audio at output port yy. xx: 01~32, * yy: 01~32, * zz: 01~16, *
sw	i	xx *	o	yy *	a	zz *	diso	[Enter]	De-embed digital audio from input xx and assign it to analog output at port yy. xx: 01~32, * yy: 01~32, * zz: 01~16, *
sw			o	yy *	a	zz *	siso	[Enter]	Assign analog audio input at port xx to analog audio output at port yy
sw			o	yy *	a	zz *	audio on audio off	[Enter]	Turn the analog audio at output port yy on or off. yy: 01~32, * zz: 01~16, *

## Mute Command

Mute allows you to enable or disable an output port(s) audio. The Mute command will turn on/off the HDMI audio and stereo audio. When the HDMI audio is off, the stereo's volume can be adjusted using the volume command.

The formula for the Mute command is as follows:

**Command + Output + Num1 + Address + Num2 + Control + [Enter]**

1. For example, to mute the audio on output port 03, type the following:  
**mute o03 on [Enter]**
2. To turn mute off on all output ports, type the following:  
**mute o\* off [Enter]**
3. To mute the audio for output port 09 on device 03, type the following:  
**mute o09 a03 on [Enter]**

The following tables show the possible values for the **Mute** command:

Command	Description
mute	Mute command
Output	Description
o	Output port command
Num1	Description
xx	Output port number xx: 01~32 (default is 01)
*	All output ports
Address	Description
a	Device address command (RS-422 and RS-485 only)
Num2	Description
zz	Device address zz: 01~16 (default is 01) (RS-422 and RS-485 only)
*	All devices
Control	Description
on	Mute on; audio on output port is disabled

Control	Description
off	Mute off; audio on output port is enabled (default)

- Note:**
1. Each command string can be separated with a space.
  2. The **Address** command is for RS-422/485 only. If the address parameter is missing from RS-422/485 commands, the default **a00** will be used. Skip the address for RS-232 commands.
  3. Skip the **Output** command to mute or enable the audio of all output ports.

The following table shows the available command list:

Command	Output	Num1	Address	Num2	Control	Enter	Description
mute	o	xx *	a	zz *	on	[Enter]	Mute audio for output port xx, on device zz xx:01~32, * zz: 01~16,*
mute	o	xx *	a	zz *	off	[Enter]	Turn mute off for output port xx, on device zz xx:01~32, * zz: 01~16,*



## **Volume Command**

The volume command allows adjusts the stereo volume for an output port.

The formula for the Volume command is as follows:

**Command + Output + Num1 + Address + Num2 + Volume + Control + [Enter]**

1. For example, to adjust the volume for output port 06 to level 5, type the following:

**volume o06 v05 [Enter]**

2. To adjust the volume for all output ports to level 04, type the following:

**volume o\* v04 [Enter]**

3. For example, to adjust the volume for output port 06 on device 01 to level 10, type the following:

**volume o06 a01 v10 [Enter]**

The following tables show the possible values for the **Volume** command:

<b>Command</b>	<b>Description</b>
volume	Volume command

<b>Output</b>	<b>Description</b>
o	Output port command

<b>Num1</b>	<b>Description</b>
xx	Output port xx: 01~32 (default is 01)
*	All output ports

<b>Address</b>	<b>Description</b>
a	Device address command (RS-422 and RS-485 only)

<b>Num2</b>	<b>Description</b>
yy	Device address yy: 01~16 (default is 01) (RS-422 and RS-485 only)
*	All devices

<b>Volume</b>	<b>Description</b>
v	Volume level command

Control	Description
zz	Audio volume level zz: 01~10 (default is 10)

- 
- Note:** 1. Each command string can be separated with a space.
2. The **Address** command is for RS-422/485 only. If the address parameter is missing from RS-422/485 commands, the default **a00** will be used. Skip the address for RS-232 commands.
- 

The following table shows the available command list:

Command	Output	Num1	Address	Num2	Vol- ume	Control	Enter	Description
volume	o	xx *	a	yy *	v	zz	[Enter]	Adjust volume for output port xx, on device yy, to level zz xx: 01~32 * yy: 01~16,* zz: 01~10,*

## Load Profile Commands

The Load Profile command allows you to apply one or multiple profiles to the display zones.

The formula for Load Profile command is as follows:

**profile f + Num1 + Address + Num2 + Control + [Enter]**

1. To load connection profile 04, type the following:

**profile f04 load [Enter]**

2. To load multiple profiles, type the following:

**profile f1, 2, 4 load [Enter]**

---

**Note:** Each specified profile will be applied to the associated display zone. If two or more profiles associated with the same display zone are included in the command, the last one will be applied.

---

The following tables show the possible values for commands:

Command	Description
profile	Load profile

Profile	Description
f	Profile command

Num1	Description
xx	Profile number xx: 01-64 (default is 01)

Address	Description
a	Device address command (RS-422 and RS-485 only)

Num2	Description
yy	Device address

Control	Description
load	Load a profile

- Note:**
1. Each command string can be separated with a space.
  2. The **Address** command is for RS-422/485 only. If the address parameter is missing from RS-422/485 commands, the default **a00** will be used. Skip the address for RS-232 commands.
  3. If the **Address** or **Profile** parameter is skipped the default value will be used.
- 

The following table shows the available command list:

Command	Profile	Num1	Address	Num2	Control	Enter	Description
profile	f	xx	a	yy *	load	[Enter]	Load profile xx on device yy xx:01~64 yy:01~16

## EDID Mode Command

Extended Display Identification Data (EDID) is a data that contains a display's basic information and is used to communicate with the video source. The EDID Mode commands allow you to change the EDID setting.

The formula for the EDID command is as follows:

**Command + Address + Number + Control + [Enter]**

1. For example, for port 06 to use the remix EDID mode, type:  
**edid a06 remix [Enter]**
1. For example, to use Port1 EDID mode for all devices, type:
2. **edid a\* port1 [Enter]**

The following tables show the possible values for the **EDID** command:

Command	Description
edid	EDID command
Address	Description
a	Device address command (RS-422 and RS-485 only)
Number	Description
zz	Device address zz: 01~16 (default is 01) (RS-422 and RS-485 only)
*	All devices
Control	Description
port1	Implement the EDID of the connected display to Port 1, and pass it to the video source.
remix	Implement the EDID of each connected display according to its connection when the VM3200 / VM3250 is first powered on, or immediately after selecting the Remix option.
default	Implements ATEN's default EDID. (default)
custom	Implements the customized mode as set in the EDID system settings. ( <b>See EDID Settings</b> , page 118)

- Note:** 1. Each command string can be separated with a space.
2. The **Address** command is for RS-422/485 only. If the address parameter is missing from RS-422/485 commands, the default **a00** will be used. Skip the address for RS-232 commands.
- 

The following table lists the available EDID commands:

Command	Address	Num	Control	Enter	Description
edid	a	ZZ *	port1	[Enter]	The EDID from Port 1 is passed to the video source. zz: 01~16
edid	a	ZZ *	remix	[Enter]	The VM3200 / VM3250 implements the EDID of each connected display according to its connection when the device is first powered on, or immediately after selecting the Remix option.
edid	a	ZZ *	default	[Enter]	ATEN's default EDID is passed to the video source.
edid	a	ZZ *	custom	[Enter]	Implements the customized mode.

## CEC Command

Consumer Electronics Control (CEC) allows interconnected HDMI devices to communicate and respond to the same remote control.

The formula for the CEC command is as follows:

**Command + Output + Number + Control + [Enter]**

- For example, to enable the CEC function on output port 1, type:  
**cec o01 on [Enter]**

The following tables show the possible values for the CEC command:

Command	Description
cec	CEC command
Output Command	Description
o	Output port command
Number	Description
yy	Output port 01~32 port (default is 01)
*	All output ports
Control	Description
off	Disable CEC (default)
on	Enable CEC

**Note:** Each command string can be separated with a space.

The following table lists the available CEC commands:

Command	Output Port	Control	Enter	Description
cec	yy *	off	[Enter]	CEC off for output port yy (default) (yy:01~32, *)
cec	yy *	on	[Enter]	CEC on for output port yy (yy:01~32, *)

## Read Command

The Read command allows you to view information about the devices.

The formula for the Read command is as follows:

**Command + Address + Number + [Enter]**

1. To view information, type:

**read [Enter]**

1. To view information about device 02, type:

**read a02 [Enter]**

The following table shows the possible values for the **Read** command:

Command	Description
read	Read command
Address	Description
a	Device address command (RS-422 and RS-485 only)
Number	Description
zz	Device address zz: 01~16 (default is 01) (RS-422 and RS-485 only)
*	All Devices

---

**Note:** The **Address** command is for RS-422/485 only. If the address parameter is missing from RS-422/485 commands, the default **a00** will be used. Skip the address for RS-232 commands.

---

The following table lists the available Read commands:

Command	Address	Num	Enter	Description
read	a	zz *	[Enter]	View information about device number zz: 01~16

### DVI/HDMI Example:

read Command OK

o01 i03 video on i06 audio v10 HDMI-A on 1080p

o02 i04 video off i06 audio off HDMI-A off bypass

o03 i02 video on i06 audio v10 HDMI-A off 1600



How to read the commands:

1. o01 i03 video on i06 audio v10 HDMI-a on 1080p

**Output 01** is connected to **Input 03** with **video on**; **audio** is **on** from **Input 06** with **volume 10** using the **HDMI** audio source; the resolution is scaled to **1080p**

2. o01 i03 video on i06 audio v10 1080p

**Output 01** is connected to **Input 03** with **video on**; **audio** is on with **volume 10**; the resolution is scaled to **1080p**

3. o02 i04 video off i06 audio off HDMI-a off bypass

**Output 02** is connected to **Input 04** with **video off**; **audio** is **off** from **Input 06** using the **HDMI** audio source; scaling is **bypassed** (turned off)

## **Reset Command**

The Reset command allows you to reset the VM3200 / VM3250 back to the default factory settings. Reset includes resetting the devices IP address.

The formula for the Reset command is as follows:

**Command + Address + Number + [Enter]**

1. To reset the VM3200 / VM3250, type:  
**reset [Enter]**

1. To reset device 02, type:  
**reset a02 [Enter]**

The following tables show the possible values for the **Reset** command:

<b>Command</b>	<b>Description</b>
reset	Reset command

<b>Address</b>	<b>Description</b>
a	Device address command (RS-422 and RS-485 only)

<b>Device Number</b>	<b>Description</b>
zz	Device address zz: 01~16 (default is 01) (RS-422 and RS-485 only)
*	All Devices

---

**Note:** 1. Each command string can be separated with a space.

2. The **Address** command is for RS-422/485 only. If the address parameter is missing from RS-422/485 commands, the default **a00** will be used. Skip the address for RS-232 commands.

---

The following table lists the available Reset commands:

<b>Command</b>	<b>Address</b>	<b>Num</b>	<b>Enter</b>	<b>Description</b>
reset	a	zz *	[Enter]	Resets the device settings Address; zz: 01~16 (RS-422 and RS-485 only)

---

## Baud Rate Command

The Baud Rate command allows you to set the RS-232 data rate for the VM3200 / VM3250 to use. Options are 9600, 19200 (default) 38400 and 115200.

The formula for the Baud Rate command is as follows:

**Command + Control + [Enter]**

1. For example, to set 38400 as the baud rate, type:

**baud 38400 [Enter]**

The following tables show the possible values for the **Baud Rate** command:

Command	Description
baud	Sets the RS-232 baud rate

Control	Description
9600	Use 9600 baud rate
19200	Use 19200 baud rate
38400	Use 38400 baud rate
115200	Use 115200 baud rate

**Note:** Each command string can be separated with a space.

The following table lists the available Baud Rate commands:

Command	Control	Enter	Description
baud	9600 / 19200 / 38400 / 115200	[Enter]	Sets the baud rate

## OSD Command

To enable or disable the On-Screen Display (OSD) for displays, use the following command:

**Command + Output + Number + Control + [Enter]**

1. For example, to enable the OSD for output 07, type:

**osd o07 on [Enter]**

2. For example, to disable the OSD for all outputs, type:

**osd o\* off [Enter]**

The following tables show the possible values for the **OSD** command:

Command	Description
osd	OSD command

Output	Description
o	Output port command

Number	Description
yy	Output port 01~32 port (default is 01)
*	All output ports

Control	Description
on	Enable OSD function
off	Disable OSD function (default)

---

**Note:** Each command string can be separated with a space.

---

The following table lists the available OSD commands:

Command	Output Port	Control	Enter	Description
osd	yy *	on	[Enter]	OSD on for output yy yy:01~32, *
osd	yy *	off	[Enter]	CEC off for output yy (default) yy:01~32, *

## Echo Command

The Echo function updates the RS232 controller when operations are made via the front panel pushbuttons, web browser or telnet. The changes echo back to the RS232 controller to keep the settings in sync with the device.

The formula for the Echo command is as follows:

**Command + Control + [Enter]**

1. For example, to enable the echo feature, type:

**echo on [Enter]**

The following tables show the possible values for the **Echo** command:

Command	Description
echo	Echo command

Control	Description
on	Turns Echo function on
off	Turns Echo function off (default)

---

**Note:** Each command string can be separated with a space.

---

The following table lists the available Echo commands:

Command	Control	Enter	Description
echo	on	[Enter]	Turn on Echo function
echo	off	[Enter]	Turn off Echo function

## Scaling Command

The Scaling command allows you to set a resolution for scaling the display connected to an output port.

The formula for the Scaling command is as follows:

**Command + Output + Number 1 + Address + Number 2 + Horizontal Resolution + Number 3+ Vertical Resolution + Number 4 + Frequency + Number 5 + Control + [Enter]**

1. For example, to turn scaling off for output port 02, type:  
**scaling o02 off [Enter]**
2. To set the scaling for output port 04 to 1920x1080@60Hz, type:  
**scaling o04 1080p [Enter]**
3. To set the scaling for all output ports on all devices to the connected display's native resolution, type:  
**scaling o\* a\* native [Enter]**

The following tables show the possible values for the **Scaling** command:

Command	Description
scaling	Scaling command

Output	Description
o	Output command

Num1	Description
yy	Output port yy: 01~32 (default is 01)
*	All output ports

Address	Description
a	Device address command (RS-422 and RS-485 only)

Num2	Description
zz	Device Address zz: 01~16 (RS-422 and RS-485 only)
*	All Devices

Horizontal Resolution	Description
hor	Horizontal resolution command for scaling

Resolution Number	Description
hhhh	Horizontal resolution

Vertical Resolution	Description
ver	Vertical resolution command for scaling

Resolution Number	Description
vvvv	Vertical resolution

Frequency	Description
freq	Frequency command for scaling

Frequency Number	Description
fff	Frequency resolution

Horizontal Resolution	Description
hor	Horizontal resolution command for scaling

Control	Description
off	Turn off the scaling function (by pass mode)
native	Map display's native resolution for scaling (default)

- 
- Note:** 1. Each command string can be separated with a space.
2. The **Address** command is for RS-422/485 only. If the address parameter is missing from RS-422/485 commands, the default **a00** will be used. Skip the address for RS-232 commands.

3. The **Port Number** command string can be skipped, and the default value will be used.

The following table lists the available Scaling commands:

Com	Out	N1	Add	N2	Horizontal Res	N3	Vertical Res	N4	Frequency	N5	Cont	Enter	Description
scaling	o	yy*	a	zz*	hor		ver		freq		off	[Enter]	Turn off scaling for output yy device zz (by pass mode)  yy: 01~32 or * zz: 01~16 or *
scaling	o	yy*	a	zz*	hor		ver		freq		native	[Enter]	Enable display's native resolution for scaling on output yy device zz (default)  yy: 01~32 or * zz: 01~16 or *
scaling	o	yy*	a	zz*	hor	1920	ver	1080	freq	60		[Enter]	Scale output yy device zz to 1920x1080@60Hz  yy: 01~32 or * zz: 01~16 or *



Com	Out	N1	Add	N2	Horizontal Res	N3	Vertical Res	N4	Frequency	N5	Cont	Enter	Description
scaling	o	yy*	a	zz*	hor	1280	ver	720	freq	60		[Enter]	Scale output yy device zz to 1280x720 @60Hz yy: 01~32 or * zz: 01~16 or *
scaling	o	yy*	a	zz*	hor	1920	ver	1200	freq	60		[Enter]	Scale output port yy device zz to 1920x1200 @60Hz yy: 01~32 or * zz: 01~16 or *
scaling	o	yy*	a	zz*	hor	1600	ver	1200	freq	60		[Enter]	Scale output yy device zz to 1600x1200 @60Hz yy: 01~32 or * zz: 01~16 or *
scaling	o	yy*	a	zz*	hor	1400	ver	1050	freq	60		[Enter]	Scale output yy device zz to 1400x1050 @60Hz yy: 01~32 or * zz: 01~16 or *

Com	Out	N1	Add	N2	Horizontal Res	N3	Vertical Res	N4	Frequency	N5	Cont	Enter	Description
scaling	o	yy*	a	zz*	hor	1280	ver	1024	freq	60		[Enter]	Scale output yy device zz to 1280x1024@60Hz yy: 01~32 or * zz: 01~16 or *
scaling	o	yy*	a	zz*	hor	1024	ver	768	freq	60		[Enter]	Scale output yy device zz to 1024x768@60Hz yy: 01~32 or * zz: 01~16 or *

## **Fan Speed Command**

The Fan Speed command allows you to set the VM3200 / VM3250's internal fan speed.

To set the fan speed, use the following command:

**Command + Control + [Enter]**

1. For example, to set the fan to auto detect, type:

**fan auto [Enter]**

The following tables show the possible values for the **Fan Speed** command:

Command	Description
fan	Fan Speed Command

Control	Description
low	Set internal fan to low speed
mid	Set internal fan to normal speed
high	Set internal fan to high speed
auto	Set internal fan to auto detect (default)

---

**Note:** Each command string can be separated with a space.

---

The following table lists the available Fan Speed commands:

Command	Control	Enter	Description
fan	low	[Enter]	Sets fan speed to low
fan	mid	[Enter]	Sets fan speed to normal
fan	high	[Enter]	Sets fan speed to high
fan	auto	[Enter]	Sets fan speed to auto detect (default)

## Alert Command

To trigger a warning when issues arise for a specific input port, use the following command:

**Command + Input + Number + Control + [Enter]**

- For example, to enable the basic Alert function for input port 1, type:

**alert i01 m1 [enter]**

The following tables show the possible values for the **Alert** command:

Command	Description
alert	Alert command
Input	Description
i	Input command
Port number	Description
yy	01-32 port
Control	Description
off	Disable Alert (default)
m1	Show basic Alert (flashing border)
m2	Show detailed Alert (flashing border and port information)

**Note:** Each command string can be separated with a space.

The following table lists the available Alert commands:

Command	Input Command	Input Port	Control	Enter	Description
alert	i	yy	off	[Enter]	Alert off for input port yy (yy:01~32)
alert	i	yy	m1	[Enter]	Basic Alert on for input port yy (yy:01~32)
alert	i	yy	m2	[Enter]	Detailed Alert on for input port yy (yy:01~32)

## **FrameSync Command**

The FrameSync command allows you enable or disable the Frame Synchronization function on the VM3200 / VM3250.

**Note:** This feature is only supported by VM8814.

The formula for the Frame Synchronization command is as follows:

**Command + Control + [Enter]**

For example, to enable the Frame Synchronization function, type:

**frsync on [Enter]**

The following tables show the possible values for the **FrameSync** command:

<b>Command</b>	<b>Description</b>
frsync	Frame Synchronization command
<b>Control</b>	<b>Description</b>
off	Turn off the Frame Synchronization function
on	Turn on the Frame Synchronization function

**Note:** Each command string can be separated with a space.

The following table lists the available FrameSync commands:

<b>Command</b>	<b>Control</b>	<b>Enter</b>	<b>Description</b>
frsync	off	[Enter]	Turn off the Frame Synchronization function
frsync	on	[Enter]	Turn on the Frame Synchronization function

## **Long Reach Mode Command**

Long Reach Mode allows you to extend the maximum transmission distance to 150m.

**Note:** This feature is only supported by VM8514.

The formula for the Long Reach Mode command is as follows:

**Command + Output<port\_number> + Control + [Enter]**

For example, to enable Long Reach Mode for port 1 on the output board, type the following:

**vslongreach o01 on [Enter]**

The following tables show the possible values for the **Long Reach Mode** command:

<b>Command</b>	<b>Description</b>
vslongreach	Long Reach Mode command

<b>Control</b>	<b>Description</b>
off	Turn off Long Reach Mode for all output ports
on	Turn on Long Reach Mode for the specified output port

---

**Note:** Each command string can be separated with a space.

---

The following table lists the available Long Reach Mode commands:

<b>Command</b>	<b>Output Port</b>	<b>Control</b>	<b>Enter</b>	<b>Description</b>
vslongreach	o	off	[Enter]	Turn off Long Reach Mode
vslongreach		on	[Enter]	Turn on Long Reach Mode

## **Standby Mode Command**

Standby mode is a power-saving mode that shuts parts of the system down to allow the user to quickly resume operation when needed.

The formula for the standby mode command is as follows:

**Command + Control + [Enter]**

For example, to enable standby mode, type the following:

**standby on [Enter]**

The following tables show the possible values for the standby mode command:

<b>Command</b>	<b>Description</b>
standby	Standby mode command

<b>Control</b>	<b>Description</b>
off	Turn off standby mode for all output ports
on	Turn on standby mode for the specified output port

---

**Note:** Each command string can be separated with a space.

---

The following table lists the available standby mode commands:

<b>Command</b>	<b>Control</b>	<b>Enter</b>	<b>Description</b>
standby	off	[Enter]	Disable the standby mode
standby	on	[Enter]	Enable the standby mode

## **Schedule Command**

The Schedule command allows you enable or disable the schedule function for VM3200 / VM3250.

The formula for the Schedule command is as follows:

**Command + Input + Number + Control + [Enter]**

1. For example, to enable the Schedule function for zone A, type:  
**schedule task01 on [enter]**
2. For example, to enable the Schedule function for all zones, type:  
**schedule task\* on [enter]**
3. For example, to disable the Schedule function for all zones, type:  
**schedule off [enter]**

The following tables show the possible values for the **Alert** command:

Command	Description
schedule	Schedule command

Schedule	Description
task	Task command

Zone Number	Description
yy	01-04 schedule zone. <ul style="list-style-type: none"><li>◆ 01 = Zone A</li><li>◆ 02 = Zone B</li><li>◆ 03 = Zone C</li><li>◆ 04 = Zone D</li></ul>
*	All schedule zones (default)

Control	Description
on	Turns Schedule function on
off	Turns Schedule function off (default)

---

**Note:** Each command string should be separated with a space.

---



The following table lists the available Alert commands:

Command	Schedule	Zone Number	Control	Enter	Description
schedule	task	yy *	on	[Enter]	Schedule for zone number yy (yy:01~04, *)
schedule	task	yy	off	[Enter]	Schedule for zone number yy (default) (yy:01~04)

This Page Intentionally Left Blank

## Safety Instructions

---

### General

- ◆ Read all of these instructions. Save them for future reference.
- ◆ Follow all warnings and instructions marked on the device.
- ◆ This product is for indoor use only.
- ◆ Do not place the device on any unstable surface (cart, stand, table, etc.). If the device falls, serious damage will result.
- ◆ Do not use the device near water.
- ◆ Do not place the device near, or over, radiators or heat registers.
- ◆ The device cabinet is provided with slots and openings to allow for adequate ventilation. To ensure reliable operation, and to protect against overheating, these openings must never be blocked or covered.
- ◆ The device should never be placed on a soft surface (bed, sofa, rug, etc.) as this will block its ventilation openings. Likewise, the device should not be placed in a built in enclosure unless adequate ventilation has been provided.
- ◆ Never spill liquid of any kind on the device.
- ◆ Unplug the device from the wall outlet before cleaning. Do not use liquid or aerosol cleaners. Use a damp cloth for cleaning.
- ◆ The device should be operated from the type of power source indicated on the marking label. If you are not sure of the type of power available, consult your dealer or local power company.
- ◆ The device is designed for IT power distribution systems with 230V phase-to-phase voltage.
- ◆ To prevent damage to your installation it is important that all devices are properly grounded.
- ◆ The device is equipped with a 3-wire grounding type plug. This is a safety feature. If you are unable to insert the plug into the outlet, contact your electrician to replace your obsolete outlet. Do not attempt to defeat the purpose of the grounding-type plug. Always follow your local/national wiring codes.
- ◆ Do not allow anything to rest on the power cord or cables. Route the power cord and cables so that they cannot be stepped on or tripped over.

- ◆ If an extension cord is used with this device make sure that the total of the ampere ratings of all products used on this cord does not exceed the extension cord ampere rating. Make sure that the total of all products plugged into the wall outlet does not exceed 15 amperes.
- ◆ To help protect your system from sudden, transient increases and decreases in electrical power, use a surge suppressor, line conditioner, or un-interruptible power supply (UPS).
- ◆ Position system cables and power cables carefully; Be sure that nothing rests on any cables.
- ◆ Never push objects of any kind into or through cabinet slots. They may touch dangerous voltage points or short out parts resulting in a risk of fire or electrical shock.
- ◆ Do not attempt to service the device yourself. Refer all servicing to qualified service personnel.
- ◆ If the following conditions occur, unplug the device from the wall outlet and bring it to qualified service personnel for repair.
  - ◆ The power cord or plug has become damaged or frayed.
  - ◆ Liquid has been spilled into the device.
  - ◆ The device has been exposed to rain or water.
  - ◆ The device has been dropped, or the cabinet has been damaged.
  - ◆ The device exhibits a distinct change in performance, indicating a need for service.
  - ◆ The device does not operate normally when the operating instructions are followed.
- ◆ Only adjust those controls that are covered in the operating instructions. Improper adjustment of other controls may result in damage that will require extensive work by a qualified technician to repair.
- ◆ Avoid circuit overloads. Before connecting equipment to a circuit, know the power supply's limit and never exceed it. Always review the electrical specifications of a circuit to ensure that you are not creating a dangerous condition or that one does not already exist. Circuit overloads can cause a fire and destroy equipment.

## **Rack Mounting**

- ◆ Before working on the rack, make sure that the stabilizers are secured to the rack, extended to the floor, and that the full weight of the rack rests on the floor. Install front and side stabilizers on a single rack or front stabilizers for joined multiple racks before working on the rack.
- ◆ Always load the rack from the bottom up, and load the heaviest item in the rack first.
- ◆ Make sure that the rack is level and stable before extending a device from the rack.
- ◆ Do not overload the AC supply branch circuit that provides power to the rack. The total rack load should not exceed 80 percent of the branch circuit rating.
- ◆ Make sure that all equipment used on the rack – including power strips and other electrical connectors – is properly grounded.
- ◆ Ensure that proper airflow is provided to devices in the rack.
- ◆ Ensure that the operating ambient temperature of the rack environment does not exceed the maximum ambient temperature specified for the equipment by the manufacturer.
- ◆ Do not step on or stand on any device when servicing other devices in a rack.

## Technical Support

---

### International

- ◆ For online technical support – including troubleshooting, documentation, and software updates: <http://eservice.aten.com>
- ◆ For telephone support, see *Telephone Support*, page x:

### North America

Email Support		<a href="mailto:support@aten-usa.com">support@aten-usa.com</a>
Online Technical Support	Troubleshooting Documentation Software Updates	<a href="http://www.aten-usa.com/support">http://www.aten-usa.com/support</a>
Telephone Support		1-888-999-ATEN ext 4988

When you contact us, please have the following information ready beforehand:

- ◆ Product model number, serial number, and date of purchase.
- ◆ Your computer configuration, including operating system, revision level, expansion cards, and software.
- ◆ Any error messages displayed at the time the error occurred.
- ◆ The sequence of operations that led up to the error.
- ◆ Any other information you feel may be of help.

# Specifications

## VM3250

<b>Input and Output Boards</b>	
Board Input	8 x Slot
Board Output	8 x Slot
<b>Video Input</b>	
Interfaces	Depends on which I/O board is inserted
Max. Data Rate	22.5 Gbps
<b>Audio</b>	
Input	Depends on which Input board is inserted
Output	Depends on which Output board is inserted
<b>Control</b>	
RS-232	Connector: 1 x DB-9 Female (Black) Serial Control Pin Configurations: Pin2 = Tx, Pin 3=Rx, Pin 5= Gnd Baud Rate and Protocol: Baud Rate:19200, Data Bits:8, Stop Bits:1, Parity: No, Flow Control: No
RS-485/RS-422	Connector: 1 x Captive Screw Connector, 5 Pole
Ethernet	Connector: 1 x RJ-45 Female
<b>EDID Settings</b>	
EDID Mode	Default, Port1, Remix, Customized (EDID Wizard support)
<b>Power</b>	
Connectors	1 x 3-Prong AC Socket
Maximum Input Power Rating	100-240 VAC; 50-60Hz; 1.0A
Consumption	AC110V:800W AC220V:800W

<b>Environmental</b>	
Operating Temperature	0–40°C
Storage Temperature	-20–60°C
Humidity	0–80% RH, Non-condensing
<b>Physical Properties</b>	
Housing	Metal
Weight	18.20 kg (40.09 lb)
Dimensions (L x W x H)	48.20 x 47.19 x 39.90 cm (18.98 x 18.58 x 15.71 in.)
Rack Height (U Space)	9U

---



**VM3200**

<b>Input and Output Boards</b>	
Board Input	8 x Slot
Board Output	8 x Slot
<b>Video Input</b>	
Interfaces	Depends on which I/O board is inserted
Max. Data Rate	15.2 Gbps (3.8 Gbps per lane)
<b>Audio</b>	
Input	Depends on which Input board is inserted
Output	Depends on which Output board is inserted
<b>Control</b>	
RS-232	Connector: 1 x DB-9 Female (Black) Serial Control Pin Configurations: Pin2 = Tx, Pin 3=Rx, Pin 5= Gnd Baud Rate and Protocol: Baud Rate:19200, Data Bits:8, Stop Bits:1, Parity: No, Flow Control: No
RS-485/RS-422	Connector: 1 x Captive Screw Connector, 5 Pole
Ethernet	Connector: 1 x RJ-45 Female
<b>EDID Settings</b>	
EDID Mode: Default / Port1 / Remix / Customized (EDID Wizard support)	
<b>Power</b>	
Connectors	1 x 3-Prong AC Socket
Maximum Input Power Rating	100-240 VAC; 50-60Hz; 1.0A
Consumption	AC110V:800W:239BTU AC220V:800W:236BTU

<b>Environmental</b>	
Operating Temperature	0–40°C
Storage Temperature	-20–60°C
Humidity	0–80% RH, Non-condensing
<b>Physical Properties</b>	
Housing	Metal
Weight	18.20 kg (40.09 lb)
Dimensions (L x W x H)	48.20 x 47.19 x 39.90 cm (18.98 x 18.58 x 15.71 in.)

**VM7584 / VM8584**

	VM7584	VM8584
<b>Fiber Optics</b>		
Date Rate	10.3 Gbps	
Wavelength	VM7584K1: 850 nm VM7584K2: 1310 nm	VM8584K1: 850 nm VM8584K2: 1310 nm
Fiber Type	VM7584K1: Multimode (MM), OM3, LC Duplex Type VM7584K2: Single-mode (SM), LC Duplex Type	VM8584K1: Multimode (MM), OM3, LC Duplex Type VM8584K2: Single-mode (SM), LC Duplex Type
<b>Video Input</b>		
Interfaces	4 x bi-directional SFP+ (LC)	
<b>Video</b>		
Max. Data Rate	10.2 Gbps (3.4 Gbps per lane)	
Max. Pixel Clock	340 MHz	
Compliance	HDMI (3D, Deep Color, 4K) HDCP 2.2 compatible Consumer Electronics Control (CEC)	
Max. Resolution	Up to 4096 x 2160 / 3840 x 2160 @ 60Hz (4:2:0); 4096 x 2160 / 3840 x 2160 @ 30Hz (4:4:4)	
Max. Distance	VM7584K1/VM8584K1: up to 300 m (MM, OM3, Black) VM7584K2/VM8584K2: up to 10 km (SM, Blue)	
<b>Control</b>		
RS-232	4 x Captive Screw Connectors, 3 pole	
IR	4 x Mini Stereo Jack Female (Black)	
<b>Power Consumption</b>		
10.54W		
<b>Environmental</b>		
Operating Temperature	0 - 40°C	
Storage Temperature	-20 - 60°C	
Humidity	0 - 80% RH, Non-Condensing	
<b>Physical Properties</b>		
Housing	Metal	
Weight	0.57 kg (1.26 lb)	

---

Dimensions (L x W x H)	35.20 x 23.8 x 2.33 cm (13.86 x 9.37 x 0.92 in.)
---------------------------	--

---

**Note:**

- ◆ The operating distance may vary depending on the fiber type, network bandwidth, connector splicing, signal losses, modal or chromatic dispersion, environmental factors, and kinks.
  - ◆ ATEN recommends using single-mode optical fibers that conform to IEC60793-2-50 B1.1 or ITU-T G.652.B specifications; multimode optical fibers that conform to IEC11801 (OM3) specifications.
  - ◆ The VM7584/VM8584 is a class 1 laser product and complies with the safety regulations of IEC-60825, FDA 21 CFR 1040.10, and FDA 21 CFR 1040.11.
-

**VM7514 / VM8514**

	<b>VM7514</b>	<b>VM8514</b>
<b>Video Input</b>		
Interfaces	4 x RJ-45 Female (Silver)	N/A
Impedance	100 $\Omega$	N/A
<b>Video Output</b>		
Interfaces	N/A	4 x RJ-45 Female (Silver)
Impedance	N/A	100 $\Omega$
<b>Video</b>		
Max. Data Rate	10.2 Gbps (3.4 Gbps per lane)	
Max. Pixel Clock	340 MHz	
Compliance	HDBaseT, HDCP 1.4 compatible Consumer Electronics Control (CEC)	
Max. Resolution	4096 x 2160 / 3840 x 2160 @ 60Hz (4:2:0); 4096 x 2160 / 3840 x 2160 @ 30Hz (4:4:4)	
Max. Distance	100 m (Cat 6a)	
<b>Control</b>		
RS-232	4 x Captive Screw Connectors, 3 pole	
IR	4 x Mini Stereo Jack Female (Black)	
<b>Power</b>		
Consumption	24.5W	12.2W
<b>Environmental</b>		
Operating Temperature	0 - 40°C	
Storage Temperature	-20 - 60°C	
Humidity	0 - 80% RH, Non-Condensing	
<b>Physical Properties</b>		
Housing	Metal	
Weight	0.64 kg / 1.41 lb	0.97 kg / 2.14 lb
Dimensions (L x W x H)	35.20 x 23.80 x 2.33 cm / 13.86 x 9.37 x 0.92 in.	

**VM7904**

<b>Video Input</b>	
Interfaces	4 x DisplayPort Female (Black)
Impedance	100 $\Omega$
Max. Distance	Up to 3m
<b>Video</b>	
Max. Data Rate	10.8 Gbps (2.7 Gbps Per Lane)
Max. Pixel Clock	340 MHz
Compliance	HDCP Compatible
Max. Resolution	4096x2160@30Hz(4:4:4) 3840x2160@30Hz(4:4:4)
<b>Audio</b>	
Input	4 x Captive Screw Connector, 5 Pole (Green) *Audio signal type: stereo, balanced/unbalanced.
<b>Power Consumption</b>	
7.18W	
<b>Environmental</b>	
Operating Temperature	0 - 40°C
Storage Temperature	-20 - 60°C
Humidity	0 - 80% RH, Non-Condensing
<b>Physical Properties</b>	
Housing	Metal
Weight	0.55 kg
Dimensions (L x W x H)	35.20 x 23.80 x 2.33 cm

**VM7824 / VM8824**

	<b>VM7824</b>	<b>VM8824</b>
<b>Video Input</b>		
Interfaces	4 x HDMI Type A Female (Black)	N/A
Impedance	100 Ω	N/A
Max. Distance	Up to 5.0 m	N/A
<b>Video Output</b>		
Interfaces	N/A	4 x HDMI Type A Female (Black)
Impedance	N/A	100 Ω
	N/A	Up to 5.0 m
<b>Video</b>		
Max. Data Rate	18.0 Gpbs (6.0 Gpbs per Lane)	
Max. Pixel Clock	600 MHz	
Compliance	HDMI (3D, Deep Color, 4K) HDCP 2.2 Compatible Consumer Electronics Control (CEC)	
Max. Resolution	4096 x 2160 / 3840 x 2160 @60Hz (4:4:4)	
<b>Audio</b>		
Input	4 x Captive Screw Connector, 5 Pole (Green)	N/A
Output	N/A	4 x Captive Screw Connector, 5 Pole
Audio Signal Type	stereo, balanced, unbalanced	
<b>Power</b>		
Consumption	DC12:8.95W:42BTU	38.97W:183BTU
<b>Environmental</b>		
Operating Temperature	0 - 40°C	
Storage Temperature	-20 - 60°C	
Humidity	0 - 80% RH, Non-Condensing	
<b>Physical Properties</b>		
Housing	Metal	
Weight	0.55 kg / 1.21 lb	0.65 kg / 1.43lb
Dimensions (L x W x H)	35.20 x 23.80 x 2.33 cm / 13.86 x 9.37 x 0.92 in.	

**VM7814 / VM8814**

	<b>VM7814</b>	<b>VM8814</b>
<b>Video Input</b>		
Interfaces	4 x HDMI Type A Female (Black)	N/A
Impedance	100 $\Omega$	N/A
Max. Distance	Up to 5m	N/A
<b>Video Output</b>		
Interfaces	N/A	4 x HDMI Type A Female (Black)
Impedance	N/A	100 $\Omega$
Max. Distance	N/A	Up to 15 m
<b>Video</b>		
Max. Data Rate	10.2 Gpbs (3.4 Gpbs per Lane)	
Max. Pixel Clock	340 MHz	
Compliance	HDMI (3D, Deep Color, 4K) HDCP 2.2 Compatible Consumer Electronics Control (CEC)	
Max. Resolution	4096 x 2160 / 3840 x 2160 @60Hz (4:2:0) 4096 x 2160 / 3840 x 2160 @30Hz (4:4:4)	
<b>Audio</b>		
Input	4 x Captive Screw Connector, 5 Pole	N/A
Output	N/A	4 x Captive Screw Connector, 5 Pole
Audio Signal Type	stereo, balanced, unbalanced	
<b>Power</b>		
Consumption	4.45W	20W
<b>Environmental</b>		
Operating Temperature	0 - 40°C	
Storage Temperature	-20 - 60°C	
Humidity	0 - 80% RH, Non-Condensing	
<b>Physical Properties</b>		
Housing	Metal	
Weight	0.56 kg / 1.23 lb	
Dimensions (L x W x H)	35.20 x 23.80 x 2.33 cm / 13.86 x 9.37 x 0.92 in.	



**VM7804 / VM8804**

	<b>VM7804</b>	<b>VM8804</b>
<b>Video Input</b>		
Interfaces	4 x HDMI Type A Female (Black)	N/A
Impedance	100 $\Omega$	N/A
<b>Video Output</b>		
Interfaces	N/A	4 x HDMI Type A Female (Black)
Impedance	N/A	100 $\Omega$
<b>Video</b>		
Max. Data Rate	6.75 Gpbs (2.25 Gpbs per Lane)	
Max. Pixel Clock	225 MHz	
Compliance	HDMI (3D, Deep Color) HDCP 1.4 Compatible Consumer Electronics Control (CEC)	
Max. Resolution	1920 x 1080	
Max. Distance	15 m	
<b>Audio</b>		
Input	4 x Captive Screw Connector, 5 Pole	N/A
Output	N/A	4 x Captive Screw Connector, 5 Pole
Audio Signal Type	stereo, balanced, unbalanced	
<b>Power</b>		
Consumption	7W	23.13W
<b>Environmental</b>		
Operating Temperature	0 - 40°C	
Storage Temperature	-20 - 60°C	
Humidity	0 - 80% RH, Non-Condensing	
<b>Physical Properties</b>		
Housing	Metal	
Weight	0.58 kg / 1.28 lb	
Dimensions (L x W x H)	35.20 x 23.80 x 2.33 cm / 13.86 x 9.37 x 0.92 in.	

**VM7604 / VM8604**

	<b>VM7604</b>	<b>VM8604</b>
<b>Video Input</b>		
Interfaces	4 x DVI-D Female (White)	N/A
Impedance	100 $\Omega$	N/A
<b>Video Output</b>		
Interfaces	N/A	4 x DVI-D Female (White)
Impedance	N/A	100 $\Omega$
<b>Video</b>		
Max. Data Rate	6.75 Gbps (2.25 Gbps per Lane)	
Max. Pixel Clock	225 MHz	
Compliance	HDCP 1.4 Compatible	
Max. Resolution	1920 x 1200	
Max. Distance	5 m	
<b>Audio</b>		
Input	4 x Captive Screw Connector, 5 Pole	N/A
Output	N/A	4 x Captive Screw Connector, 5 Pole
Audio Signal Type	stereo, balanced, unbalanced	
<b>Power</b>		
Consumption	10.62W	20.10W
<b>Environmental</b>		
Operating Temperature	0 - 40°C	
Storage Temperature	-20 - 60°C	
Humidity	0 - 80% RH, Non-Condensing	
<b>Physical Properties</b>		
Housing	Metal	
Weight	0.55 kg / 1.21 lb	
Dimensions (L x W x H)	35.20 x 23.80 x 2.33 cm / 13.86 x 9.37 x 0.92 in.	

**VM7104**

<b>Video Input</b>	
Interfaces	4 x HDB-15 Female (Blue)
Impedance	75 $\Omega$
Max. Bandwidth	300 MHz
Max. Resolution	1920 x 1200
Max. Distance	1.8 m
<b>Audio Input</b>	
Interfaces	4 x Captive Screw Connector, 5 Pole
Audio Signal Type	stereo, balanced, unbalanced*
<b>Power</b>	
Consumption	7.1W
<b>Environmental</b>	
Operating Temperature	0 - 40°C
Storage Temperature	-20 - 60°C
Humidity	0 - 80% RH, Non-Condensing
<b>Physical Properties</b>	
Housing	Metal
Weight	0.56 kg / 1.23 lb
Dimensions (L x W x H)	35.20 x 23.80 x 2.33 cm / 13.86 x 9.37 x 0.92 in.

**Note:** The maximum audio input is 0.5 V<sub>rms</sub> (- 6.02 dBV @600 ohm) for balanced audio and 1 V<sub>rms</sub> (0 dBV @600 ohm) for unbalanced audio.

**VM7404**

<b>Video Input</b>	
Interfaces	4 x BNC Female
Impedance	75 $\Omega$
<b>Video</b>	
Supported Resolutions	PAL /50 PAL and NTSC/59.94 720p 25, 29.97, 30,50,59.94, 60 1080i 50, 59.94, 60 1080PsF 25, 29.97,30 1080p 23.98, 24, 25, 29.97, 30,50,59.94, 60
Max. Data Rate	2.97 Gpbs
Max. Distance	100m (3G-SDI), 150m (HD-SDI), 300m (SD-SDI)
<b>SDI Formats</b>	
3G-SDI, SMPTE-259,292,424, 425 Level A & B-DL	
<b>Audio Input</b>	
Interfaces	4 x Captive Screw Connector, 5 Pole
Audio Signal Type	stereo, balanced, unbalanced*
<b>Power</b>	
Consumption	16.0W
<b>Environmental</b>	
Operating Temperature	0 - 40°C
Storage Temperature	-20 - 60°C
Humidity	0 - 80% RH, Non-Condensing
<b>Physical Properties</b>	
Housing	Metal
Weight	0.60 kg / 1.32 lb
Dimensions (L x W x H)	35.20 x 23.80 x 2.33 cm / 13.86 x 9.37 x 0.92 in.

**Note:** The maximum audio input is 0.5 Vrms (- 6.02 dBV @600 ohm) for balanced audio and 1 Vrms (0 dBV @600 ohm) for unbalanced audio.

**VE805R**

<b>Video Input</b>	
Interfaces	1 x RJ-45 Female (Silver)
Impedance	100 $\Omega$
<b>Video Output</b>	
Interfaces	1 x HDMI Type A Female (Black)
Impedance	100 $\Omega$
<b>Video</b>	
Max. Data Rate	6.75 Gbps (2.25 Gbps per Lane)
Max. Pixel Clock	225 MHz
Compliance	HDMI (3D, Deep Color) HDCP 1.4 Compatible HDBaseT Compatible
Max. Resolution / Distance	1080p @60m (Cat 5e/6) 1080p @70m (Cat 6a)
<b>Control</b>	
RS-232	1 x Captive Screw Connector, 3 Pole
IR	1 x Mini Stereo Jack Female (Black)
<b>Power</b>	
Connectors	1 x DC Jack (Silver)
Consumption	DC5V:8.36W:39BTU
<b>Environmental</b>	
Operating Temperature	0 - 50°C
Storage Temperature	-20 - 60°C
Humidity	0 - 80% RH, Non-Condensing
<b>Physical Properties</b>	
Housing	Metal
Weight	0.81 kg / 1.78 lb
Dimensions (L x W x H)	17.74 x 16.92 x 4.20 cm / 6.98 x 6.66 x 1.65 in.

**VE816R**

<b>Video Input</b>	
Interfaces	1 x RJ-45 Female (Silver)
Impedance	100 Ω
<b>Video Output</b>	
Interfaces	1 x HDMI Type A Female (Black)
Impedance	100 Ω
<b>Video</b>	
Max. Data Rate	10.2 Gbps (3.40 Gbps per Lane)
Max. Pixel Clock	340 MHz
Compliance	HDMI (3D, 4K, Deep Color) HDCP 2.2 Compatible HDBaseT Compatible
Max. Resolution / Distance	Up to 4K@70m (Cat 5e/6) / 100m (Cat 6a/ATEN 2L-2910 Cat6); 1080p@100m (Cat 5e/6/6a)  *4K supported: 4096 x 2160 / 3840 x 2160 @ 60Hz (4:2:0); 4096 x 2160 / 3840 x 2160 @ 30Hz (4:4:4)
<b>Connectors</b>	
Unit To Unit	1 x RJ-45 Female
Power	1 x DC Jack (Sliver)
<b>Control</b>	
RS-232 Channel	1 x Terminal Block, 3 pole (Green)
IR Channel	1 x Mini Stereo Jack Female (Black)
<b>Switches</b>	
Firmware Upgrade	1 x Slide Switch - ON/OFF
<b>Power Consumption</b>	
DC5V:9.09W:28BTU	
<b>Environmental</b>	
Operating Temperature	0 - 40°C
Storage Temperature	-20 - 60°C
Humidity	0 - 80% RH, Non-Condensing
<b>Physical Properties</b>	
Housing	Metal

Weight	0.67 kg (1.48 lb)
Dimensions (L x W x H) with bracket	16.80 x 14.69 x 3.00 cm (6.61 x 5.78 x 1.18 in.)
Dimensions (L x W x H) without bracket	16.60 x 12.49 x 2.90 cm (6.54 x 4.92 x 1.14 in.)

## **VM-PWR800**

<b>Properties</b>	
Input Voltage	100~240VAC
Power Consumption	Max.Load 800W
Operating Temp.	0~40°C

## **VM-FAN556**

<b>Properties</b>	
Air Flow	55.2 cfm
Operating Voltage	10.2 - 12 VDC
Operating Temp.	-10 - 60°C

## Telnet Operation

---

To connect to VM3200 via Telnet, follow the steps in *Commands*, page 143.

### **Configuration Menu**

Once a Telnet connection to the VM3200 is established, the device's text-based Configuration Menu comes up, with the following items:

#### **1. H – Call up the command list for help**

Command list:

IP – Set IP address

LO – Load connections from profile *nn*

PW – Change password

RI – Read what input is connected to *nn* output

RO – Read what output is connected to *nn* input

SB – Set the serial port baud rate

SS – Switch input to specified port

TI – Set timeout

VR – Software version information

Ctrl-Q – Quit

#### **2. IP – Set IP address**

IP

Old IP address: 192.168.0.60

New IP address:

#### **3. LO – Load connections from profile**

LO 01

Load profile 01 OK.



**4. PW – Change password**

PW

Old password: \*\*\*\*\*

New password:

**5. RI – Read what input is connected to *nn* output**

RI 01

Input port 02 04 08 is connected to output port 01

**6. RO – Read what output is connected to *nn* input**

RO 01

Output port 02 is connected to input port 01

**7. SB – Set serial port baud rate**

SB 96

Serial port baud rate is set to 9600

**8. SS – Switch input to specified output**

SS 01, 03

Switch input 01 to output 03 (00: Local Port)

**9. TI – Set timeout**

TI 30

Set 30 minute timeout

**10. VR – Software version information**

VR

Software version 1.0.

## Limited Warranty

---

ATEN warrants its hardware in the country of purchase against flaws in materials and workmanship for a Warranty Period of two [2] years (warranty period may vary in certain regions/countries) commencing on the date of original purchase. This warranty period includes the [LCD panel of ATEN LCD KVM switches](#). Select products are warranted for an additional year (see [A+ Warranty](#) for further details). Cables and accessories are not covered by the Standard Warranty.

### **What is covered by the Limited Hardware Warranty**

ATEN will provide a repair service, without charge, during the Warranty Period. If a product is defective, ATEN will, at its discretion, have the option to (1) repair said product with new or repaired components, or (2) replace the entire product with an identical product or with a similar product which fulfills the same function as the defective product. Replaced products assume the warranty of the original product for the remaining period or a period of 90 days, whichever is longer. When the products or components are replaced, the replacing articles shall become customer property and the replaced articles shall become the property of ATEN.

To learn more about our warranty policies, please visit our website:  
<http://www.aten.com/global/en/legal/policies/warranty-policy/>

© Copyright 2021 ATEN® International Co., Ltd.  
Released: 2021-06-16

ATEN and the ATEN logo are registered trademarks of ATEN International Co., Ltd. All rights reserved. All other brand names and trademarks are the registered property of their respective owners.