

USER MANUAL

MODELS:

TP-594Txr HDMI Line Transmitter

TP-594Rxr HDMI Line Receiver



Contents

Introduction	1
Getting Started	1
Overview	2
Typical Applications	4
Defining the Transmitter and Receiver	5
Defining TP-594Txr	5
Defining TP-594Rrx	6
Mounting TP-594Txr / TP-594Rrx	7
Connecting TP-594Txr / TP-594Rrx	8
Connecting Analog Audio Output to Balanced/Unbalanced Stereo Audio Acceptor	9
Connecting Balanced/Unbalanced Stereo Audio Source to Analog Audio Balanced Input	10
Connecting to TP-594Txr / TP-594Rrx via RS-232	10
Wiring RJ-45 Connectors	11
Routing Audio Signals	12
Routing Audio Signals from TP-594Txr	12
Routing TP-594Rrx Audio Signals	16
Extending and Routing Control Signals	19
Extending Control Signals via HDBT	19
Extending HDMI CEC Commands via HDMI Connections	20
Routing IP-Driven Control Signals via Built-in Control Gateway	21
Operating and Controlling TP-594Txr and TP-594Rrx	22
Setting DIP-Switches	22
Operating via Ethernet	23
Using the Embedded Web Pages	25
Browsing Web Pages	25
Viewing General Information	28
Viewing Connected Clients	28
Changing Device Settings	29
Defining TP-594Txr Video and Audio Settings	33
Defining TP-594Rrx Video and Audio Settings	35
Managing EDID	36
Defining TP-594Rrx Gateway and Ports Activation	38
Defining TP-594Rrx Gateway Serial Port Settings	41
Setting Web Page Access Permission	42
Viewing About Page	44
Firmware Upgrade	45
Upgrading Firmware Using a Memory Stick	45
Technical Specifications	46
Default Communication Parameters	48
Default EDID	48
Protocol 3000	51
Understanding Protocol 3000	51
Protocol 3000 Commands	52
Result and Error Codes	63

Introduction

Welcome to Kramer Electronics! Since 1981, Kramer Electronics has been providing a world of unique, creative, and affordable solutions to the vast range of problems that confront the video, audio, presentation, and broadcasting professional on a daily basis. In recent years, we have redesigned and upgraded most of our line, making the best even better!

Getting Started

We recommend that you:

- Unpack the equipment carefully and save the original box and packaging materials for possible future shipment.
- Review the contents of this user manual.



Go to www.kramerav.com/downloads/TP-594Txr and www.kramerav.com/downloads/TP-594Rxr to check for up-to-date user manuals, application programs, and to check if firmware upgrades are available (where appropriate).

Achieving the Best Performance

- Use only good quality connection cables (we recommend Kramer high-performance, high-resolution cables) to avoid interference, deterioration in signal quality due to poor matching, and elevated noise levels (often associated with low quality cables).
- Do not secure the cables in tight bundles or roll the slack into tight coils.
- Avoid interference from neighboring electrical appliances that may adversely influence signal quality.
- Position your Kramer **TP-594Txr / TP-594Rxr** away from moisture, excessive sunlight and dust.

Safety Instructions



Caution:

- This equipment is to be used only inside a building. It may only be connected to other equipment that is installed inside a building.
- For products with relay terminals and GPIO ports, please refer to the permitted rating for an external connection, located next to the terminal or in the User Manual.
- There are no operator serviceable parts inside the unit.



Warning:

- Use only the power cord that is supplied with the unit.
- To ensure continuous risk protection, replace fuses only according to the rating specified on the product label which located on the bottom of the unit.

Recycling Kramer Products

The Waste Electrical and Electronic Equipment (WEEE) Directive 2002/96/EC aims to reduce the amount of WEEE sent for disposal to landfill or incineration by requiring it to be collected and recycled. To comply with the WEEE Directive, Kramer Electronics has made arrangements with the European Advanced Recycling Network (EARN) and will cover any costs of treatment, recycling and recovery of waste Kramer Electronics branded equipment on arrival at the EARN facility. For details of Kramer's recycling arrangements in your particular country go to our recycling pages at www.kramerav.com/support/recycling.

Overview

Congratulations on purchasing your Kramer **TP-594Txr HDMI Line Transmitter** and / or **TP-594Rxr HDMI Line Receiver**. **TP-594Txr** and **TP-594Rxr** are high-performance, extended-reach HDBaseT 2.0 transmitter and receiver devices for 4K60Hz (4:4:4) HDMI™, Ethernet, RS-232, IR, ARC (Audio Return Channel) and stereo audio signals over twisted pair. **TP-594Txr** converts all input signals into the transmitted HDBaseT 2.0 signal and extends them onto the receiver. **TP-594Rxr** receives extended HDBT 2.0 signals and converts them back to HDMI, Ethernet, RS-232, IR, ARC and stereo audio signals.

Both devices extend video signals to up 100m (330ft) over CAT copper cables at up to 4K@60Hz (4:4:4) 24bpp video resolution and provide even further reach for lower HD video resolutions.

TP-594Txr and **TP-594Rxr** are standard extenders that can operate together as a transmitter receiver system but can also be matched with any market-available HDBaseT-compliant Tx or Rx extender, auto-detecting and adapting to the peer device capabilities.

TP-594Txr and **TP-594Rxr** provide exceptional quality, advanced and user-friendly operation, and flexible control.

Exceptional Quality

- High Performance Standard Extender – Professional HDBaseT extenders for providing extended-reach signals over twisted-pair copper infrastructures. **TP-594Txr / TP-594Rxr** is a standard extender with backward HDBaseT compatibility, enabling it to be connected to any market-available HDBaseT-compliant extension product. It employs standard low-level video compression technology that delivers visually lossless performance for 4K@60 (4:4:4) and HDR signals with near-zero latency. For optimum extension reach and performance, use recommended Kramer cables, available at www.kramerav.com/product/TP-594Txr.
- Intelligent Compression Handling – Automatically detects a standard HDBaseT extender without compression and disables the compression to extend the signal in compliance with the detected extender.
- HDMI Signal Extension – Supports HDCP 2.2, deep color, x.v.Color™, HDMI uncompressed audio channels, Dolby TrueHD, DTS-HD, 2K, 4K, CEC, and 3D as specified in HDMI 2.0.
- Multi-channel Audio Transmission – Up to 32 channels of digital stereo uncompressed signals for supporting studio-grade surround sound.

- **Intelligent Source Forward Audio Routing:**
 - For **TP-594Txr**, when selecting to use the balanced analog stereo audio port signal, it is converted into a digital signal and embedded into the transmitted HDMI signal, replacing the embedded HDMI audio input signal. This enables embedding a selectable audio source over HDMI. For example, a presenter can display a video clip and temporarily override the audio of the source media with another audio source, such as from a microphone.
 - For **TP-594Rxr**, according to your selection, the transmitted digital audio signal may be de-embedded from the AV signal and converted to an analog signal for transmission to the stereo balanced analog audio output, as well as to the HDMI AV output. This enables high-quality audio playback by routing the audio to external speakers in addition to routing the audio to the connected AV acceptor device's local speakers (such as TV with speakers).
- **Intelligent ARC (Audio Return Channel) Routing:**
 - For **TP-594Txr**, the HDBaseT-ARC signal is routed to the HDMI input and, in parallel, you can select to route the ARC signal to the digital output and/or analog audio bidirectional port. This enables you to play the audio on high-quality external speakers and control the volume using an IR remote control either via a receiver-side AV acceptor device (such as a display) or via a transmitter-side AV acceptor device (such as an AV Receiver with speakers).
 - For **TP-594Rxr**, according to your selection, the ARC signal received from the HDMI output, the digital audio input, or the analog audio bidirectional port may be routed back to the transmitter via the HDBaseT link. This enables high-quality ARC playback and user volume control by routing the ARC to audio speakers connected on the transmitter side, either directly or via an AV acceptor device (such as an AV Receiver with speakers).
- **TP-594Rxr Built-in Intelligent Control Gateway – Remote IP-driven intelligent control of connected AV devices, via CEC (through the HDMI output) or RS-232/IR (through the corresponding output ports), using existing LAN or HDBaseT connectivity. Eliminating the need for an external control gateway, this feature reduces installation complexity and costs, to enable easy integration with control systems, such as Kramer Control.**

Advanced and User-friendly Operation

- **I-EDIDPro™ Kramer Intelligent EDID Processing™ – Intelligent EDID handling, processing and pass-through algorithm that ensures Plug and Play operation for HDMI source and display systems.**
- **Cost-effective Maintenance – Link, power and other useful LED indicators for HDMI and HDBT ports, remote web UI management and support, and RS-232 connection for local technician management and support, facilitate easy maintenance and troubleshooting. Remote firmware upgrade via Ethernet or local via USB connection, ensure lasting, field-proven deployment.**
- **Easy and Elegant Installation – Single cable connectivity for both HDBaseT signals and power. Compact MegaTOOLS™ fan-less enclosure for dropped-ceiling mounting, or side-by-side mounting of 2 units in a 1U rack space with the recommended rack adapter.**

Flexible Connectivity

- Audio Extension – Audio channel data flows in both directions, allowing extension of both transmitter forward-audio channels and receiver return-channel, to peer connected devices.
- Ethernet Extension – Ethernet interface data flows in both directions, allowing extension of up to 100Mbps Ethernet connectivity for LAN communication and device control.
- Bidirectional RS-232 Extension – Serial interface data flows in both directions, allowing data transmission and device control.
- Bidirectional Infrared Extension – IR interface data flows in both directions, allowing remote control of peripheral devices located at either end of the extended link.

Typical Applications

TP-594Txr / TP-594Rxr is ideal for the following typical applications:

- Single-cable 4K HDR AV and ARC extension for AV receiver connectivity in large residential rooms.
- Smooth integration with standard 4K AV and control systems, providing intelligent ARC and audio routing.
- Long-distance 4K HDR AV, ARC and LAN signal extension for multi-room, large dividable auditoriums and lecture hall connectivity.
- 4K HDR AV extension in conference rooms, boardrooms, control rooms, hotels and large church facilities.

Controlling your TP-594Txr / TP-594Rxr

Control your TP-594Txr / TP-594Rxr:

- By RS-232 serial commands transmitted by a touch screen system, PC, or other serial controller.
- Via the Ethernet using built-in user-friendly web pages.

Defining the Transmitter and Receiver

This section defines **TP-594Txr** transmitter and **TP-594Rxr** receiver.

Defining TP-594Txr

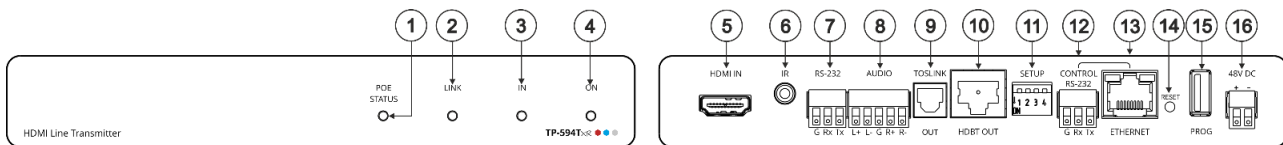

Figure 1: TP-594Txr HDMI Line Transmitter

#	Feature	Function
①	POE STATUS LED	Lights green when power is provided over the HDBT connection.
②	LINK LED	Lights green when the HDBT link is valid.
③	IN LED	Lights green when an active source device input signal is detected.
④	ON LED	Lights green when the device receives power.
⑤	HDMI IN Connector	Connect to an HDMI source.
⑥	IR 3.5mm Mini Jack Connector	Connect to an IR emitter cable to control a local device from the receiver (TP-594Rxr) side or connect to an IR sensor cable to control a remote device connected to the TP-594Rxr receiver.
⑦	RS-232 3-pin Terminal Block Connector	Connect to a controller device (for example, SL-240C) to control a remote device that is connected to TP-594Rxr via serial controller (for example, the HDMI OUT acceptor).
⑧	AUDIO 5-pin Terminal Block Connector	Connect to either a stereo balanced audio source or acceptor (the connection type is defined via the embedded web pages): <ul style="list-style-type: none"> Connect an audio source to extend an audio signal from TP-594Txr to the audio acceptor on the receiver side via the HDBT link. Connect an audio acceptor to output the audio signal received from the audio source on TP-594Rxr via the HDBT link.
⑨	TOSLINK OUT Connector	Digital audio on a TOSLINK optical female connector, for outputting the digital audio signal that is extended from the receiver to an audio acceptor.
⑩	HDBT OUT Connector	Connect to the RJ-45 HDBT IN connector on a receiver (for example, TP-594Rxr or TP-590Rxr) to extend the signals between the TP-594Txr and the receiver.
⑪	SETUP 4-way DIP-switches	Set the operation DIP-switches (see Setting DIP-Switches on page 22).
⑫	CONTROL RS-232 3-pin Terminal Block Connector	Connect to a PC to control the device.
⑬	CONTROL ETHERNET RJ-45 Connector	Connect to a PC to control the device or for LAN extension.
⑭	RESET Recessed Button	Press and hold to reset settings to factory default values.
⑮	PROG USB Port	Connect to a USB memory device to upgrade the firmware.
⑯	48V DC Power Terminal Block Connector	Connect to the supplied power adapter.

Defining TP-594Rxr

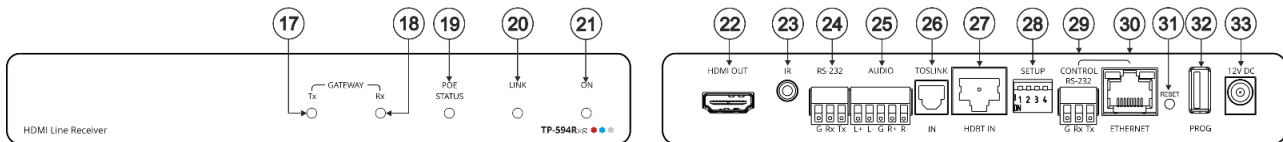

Figure 2: TP-594Rxr HDMI Line Receiver

#	Feature	Function
17	GATEWAY Tx LED	Lights blue to indicate gateway activity of any RS-232, IR or CEC signals sent, as selected in the embedded web pages.
18	GATEWAY Rx LED	Lights blue to indicate gateway activity of any RS-232, IR or CEC signals received, as selected in the embedded web pages.
19	POE STATUS LED	Lights green when power is received over the TP connection.
20	LINK LED	Lights green when the HDBT link is valid.
21	ON LED	Lights green when the device receives power.
22	HDMI OUT Connector	Connect to an HDMI acceptor.
23	IR 3.5mm Mini Jack Connector	Use for one of the following functions: <ul style="list-style-type: none"> Connect to an IR emitter cable to control a local device from the transmitter (TP-594Txr) side. Connect to an IR sensor cable to control a remote device connected to the TP-594Txr transmitter. Connect to an IR emitter cable to control an IR-enabled device via the Ethernet (see Defining TP-594Rxr Gateway and Ports Activation on page 38).
24	RS-232 3-pin Terminal Block Connector	Connect to an RS-232 device to control a remote device that is connected to TP-594Txr or connect to a device that is controlled via the Ethernet (see Defining TP-594Rxr Gateway and Ports Activation on page 38).
25	AUDIO 5-pin Terminal Block Connector	Connect to a stereo balanced audio source or an acceptor (the connection type is defined via the embedded web pages): <ul style="list-style-type: none"> Connect an audio acceptor to output the audio signal received from the audio source on the transmitter side via the HDBT link. Connect an audio source to extend an audio signal to the audio acceptor on the TP-594Txr via the HDBT link.
26	TOSLINK IN Connector	Digital audio on a TOSLINK optical female connector for digital audio input that is extended to the transmitter.
27	HDBT IN Connector	Connect to the RJ-45 HDBT OUT connector on a transmitter (for example, TP-594Txr or TP-590Txr) to extend the signals between TP-594Rxr and the transmitter.
28	SETUP 4-way DIP-switches	Set the operation DIP-switches (see Setting DIP-Switches on page 22).
29	CONTROL RS-232 3-pin Terminal Block Connector	Connect to a PC to control the device.
30	CONTROL ETHERNET RJ-45 Connector	Connect to a PC to control the device or for LAN extension.
31	RESET Recessed Button	Press and hold to reset settings to factory default values.
32	PROG USB Port	Connect to a USB memory device to upgrade the firmware.
33	12V DC Power Connector	12V DC connector for powering the unit when unit is not powered via the HDBT link by the transmitter.

Mounting TP-594Txr / TP-594Rxr

This section provides instructions for mounting **TP-594Txr/ TP-594Rxr**. Before installing, verify that the environment is within the recommended range:



- Operation temperature – 0° to 40°C (32 to 104°F).
- Storage temperature – -40° to +70°C (-40 to +158°F).
- Humidity – 10% to 90%, RHL non-condensing.



Caution:

- Mount **TP-594Txr / TP-594Rxr** before connecting any cables or power.



Warning:

- Ensure that the environment (e.g., maximum ambient temperature & air flow) is compatible for the device.
- Avoid uneven mechanical loading.
- Appropriate consideration of equipment nameplate ratings should be used for avoiding overloading of the circuits.
- Reliable earthing of rack-mounted equipment should be maintained.
- Maximum mounting height for the device is 2 meters.

To mount the TP-594Txr / TP-594Rxr in a rack:

Mount the unit in a rack using the recommended rack adapter (see www.kramerav.com/product/TP-594Txr).

To mount the TP-594Txr on a table or shelf:

- Attach the rubber feet and place the unit on a flat surface.
- Fasten a bracket (included) on each side of the unit and attach it to a flat surface.

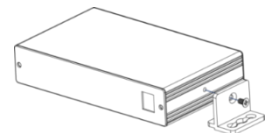

For more information go to www.kramerav.com/downloads/TP-594Txr

Connecting TP-594Txr / TP-594Rxr

The example described in this section shows the **TP-594Txr** and **TP-594Rxr** as a transmitter receiver system although they can be also matched with any market-available HDBaseT receiver or transmitter, respectively.



Always switch off the power to each device before connecting it to your **TP-594Txr** / **TP-594Rxr**. After connecting your **TP-594Txr** / **TP-594Rxr**, connect its power and then switch on the power to each device.

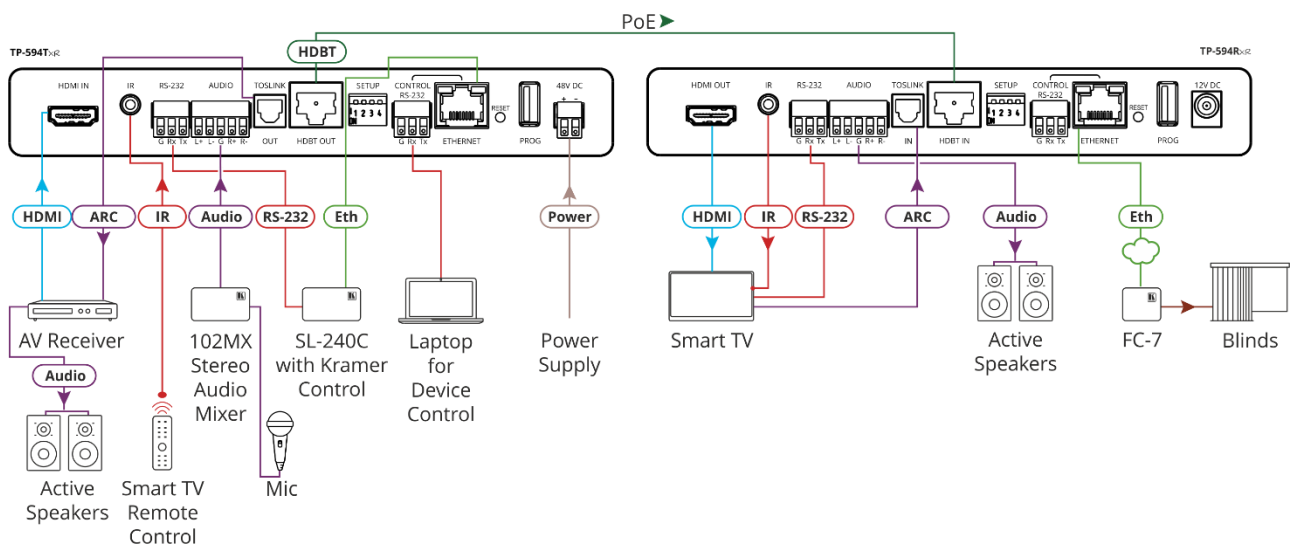

Figure 3: Connecting to the TP-594Txr Rear Panel

To connect the **TP-594Txr** and **TP-594Rxr** as illustrated in the example in [Figure 3](#):

1. Connect the AV inputs and outputs on **TP-594Txr**:
 - Connect the HDMI source (for example, an AV receiver) to the HDMI IN connector (5).
 - Connect an audio source (for example, a microphone via the Kramer 102MX 2-channel audio mixer) to the AUDIO 5-pin terminal block connector (8).
2. Connect the AV inputs and outputs on **TP-594Rxr**:
 - Connect the HDMI OUT connector (22) to an acceptor (for example, a smart TV).
 - Connect the AUDIO 5-pin terminal block connector (25) to an audio acceptor (for example, active speakers).
3. On **TP-594Txr**, connect a device controller (for example, a laptop) to the CONTROL RS-232 port (7).

4. Control the smart TV via IR:
 - On **TP-594Txr**, connect an IR sensor cable to the IR 3.5mm mini jack (6).
 - On **TP-594Rxr**, connect the IR 3.5mm mini jack (23) to an emitter cable and attach the emitter side to the IR sensor of the smart TV.
 - Point the smart TV IR remote controller to the IR sensor to pass an IR command via HDBT to the smart TV.
5. Control the smart TV via RS-232:
 - On **TP-594Txr** connect a room controller (for example, the Kramer **SL-240C** with Kramer Control) to the RS-232 3-pin terminal block connector (7).
 - On **TP-594Rxr** connect the RS-232 3-pin terminal block connector (24) to the smart TV.
 - Send RS-232 commands via the room controller to the smart TV.
6. Control the blinds:
 - On **TP-594Txr** connect a controller (for example, **SL-240C** room controller) to the ETHERNET RJ-45 port (13).
 - On **TP-594Rxr** connect the ETHERNET RJ-45 port (23) to a relay control gateway (for example, the Kramer **FC-7**).
 - On **FC-7** connect the relay to the blinds in the room.
 - Send open/close commands from **SL-240C** to **FC-7** to the blinds via the Ethernet.
7. Output the smart TV audio via TOSLINK connections to the AV receiver:
 - On **TP-594Rxr** connect the smart TV acceptor to the TOSLINK IN connector (26).
 - On **TP-594Txr** connect the TOSLINK OUT connector (9) to the AV receiver source and connect the AV receiver source to active speakers.



[Routing Audio Signals](#) on page 12 describes in detail how to connect and set the audio ports.

Connecting Analog Audio Output to Balanced/Unbalanced Stereo Audio Acceptor

The following figures illustrate the pinouts for connecting the analog audio output to a balanced or unbalanced stereo audio acceptor:

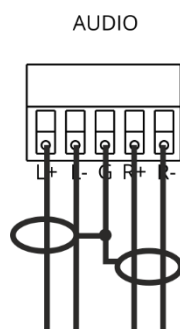

Figure 4: Connecting to a Balanced Stereo Audio Acceptor

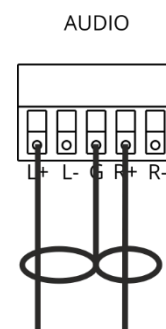

Figure 5: Connecting to an Unbalanced Stereo Audio Acceptor

Connecting Balanced/Unbalanced Stereo Audio Source to Analog Audio Balanced Input

The following figures illustrate the pinouts for connecting a balanced or unbalanced stereo audio source to the balanced analog audio input:

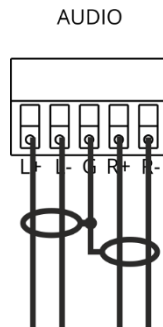

Figure 6: Connecting a Balanced Stereo Audio Source to the Balanced Input

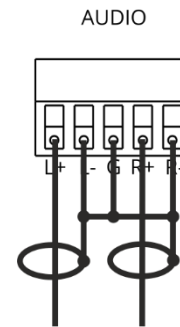

Figure 7: Connecting an Unbalanced Stereo Audio Source to the Balanced Input

Connecting to TP-594Txr / TP-594Rxr via RS-232

In this section, TP-594Txr is taken as an example (TP-594Txr and TP-594Rxr connect to RS-232 ports in the same way).

You can connect to the TP-594Txr via an RS-232 connection ⁽¹³⁾ using, for example, a PC.

The TP-594Txr features an RS-232 3-pin terminal block connector allowing the RS-232 to control the TP-594Txr or for signal-extension over HDBT.

Connect the RS-232 terminal block on the rear panel of the TP-594Txr to a PC/controller, as follows:

From the RS-232 9-pin D-sub serial port connect:

- Pin 2 to the TX pin on the TP-594Txr RS-232 terminal block
- Pin 3 to the RX pin on the TP-594Txr RS-232 terminal block
- Pin 5 to the G pin on the TP-594Txr RS-232 terminal block

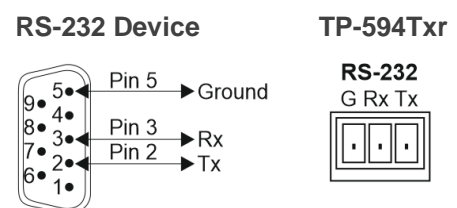

Wiring RJ-45 Connectors

This section defines the HDBaseT pinout, using a straight pin-to-pin cable with RJ-45 connectors.



For HDBT cables, it is recommended that the cable ground shielding be connected/soldered to the connector shield.

EIA /TIA 568B	
PIN	Wire Color
1	Orange / White
2	Orange
3	Green / White
4	Blue
5	Blue / White
6	Green
7	Brown / White
8	Brown

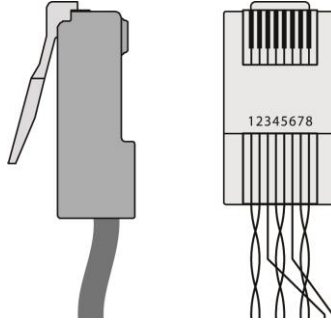

Routing Audio Signals

While video signals are routed from the HDMI input on the transmitter to the HDMI output on the receiver, audio signals can be routed in multiple ways. This section includes information on:

- [Routing Audio Signals from TP-594Txr](#) on page [12](#).
- [Routing TP-594Rxr Audio Signals](#) on page [16](#).

Routing Audio Signals from TP-594Txr

TP-594Txr provides two audio signal sources: the HDMI audio input and the analog balanced audio (when set as source). TP-594Txr enables:

- [Routing Analog Audio Source to Receiver](#) on page [12](#).
- [Routing HDMI Audio Source to Receiver](#) on page [13](#).
- [Routing Priority-Selected Audio Source to Receiver](#) on page [14](#).
- [Routing Analog Audio Source to Receiver for Auto-play when Video Signal is Unavailable](#) on page [15](#).

Routing Analog Audio Source to Receiver

To route the analog audio source to the receiver:

1. Connect an audio source to the AUDIO 5-pin terminal block connector.
2. If required, connect an HDMI source to the HDMI connector.
3. In the TP-594Txr Navigation pane, click **Video & Audio** ([Figure 29](#)). The Video and Audio page appears ([Figure 39](#)).
4. Under Audio Settings ([Figure 8](#)):
 - Set Audio Embedding Selection Mode to **Manual**.
 - Set Audio Embedding Selection Priority to **Analog**.
 - View the active audio Current Selection (Analog in this example).



When Audio Embedding Selection Priority on the TP-594Txr is set to **Analog**, ARC cannot be output via the analog AUDIO port.

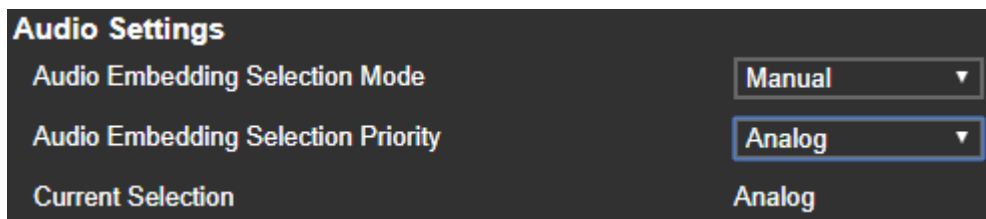

Figure 8: TP-594Txr Video and Audio Page – Analog Audio to Receiver Settings

5. In the TP-594Rxr Navigation pane, click **Video & Audio** ([Figure 30](#)) The Video and Audio settings page appears ([Figure 40](#)).

6. Under Audio Settings ([Figure 9](#)):
 - Set Audio De-embedding Source to **Line-HDMI IN**.
 - Set Audio De-embedding Destination to **Analog OUT**.



When Audio De-embedding Source and/or Destination are set to **None**, the analog AUDIO port is muted.



Figure 9: TP-594Rxr Video and Audio Page – Analog Audio to Receiver Settings



If ARC Output Source is set to **Analog IN**, the above settings are automatically set to **None** and analog output is disabled (see [Setting Audio Signal Sources and Destinations](#) on page [36](#)).

The TP-594Txr analog audio input is routed to the TP-594Rxr HDMI and analog audio outputs.

Routing HDMI Audio Source to Receiver

To route the HDMI audio source to the receiver:

1. Connect an HDMI source to the HDMI connector.
2. If required, connect an analog audio source to the AUDIO 5-pin terminal block connector.
3. In the TP-594Txr Navigation pane ([Figure 29](#)), click **Video & Audio**. The Video and Audio settings page appears ([Figure 39](#)).
4. Under Audio Settings ([Figure 10](#)):
 - Set Audio Embedding Selection Mode to **Manual**.
 - Set Audio Embedding Selection Priority to **HDMI**.
 - View the active audio Current Selection (Embedded in this example).

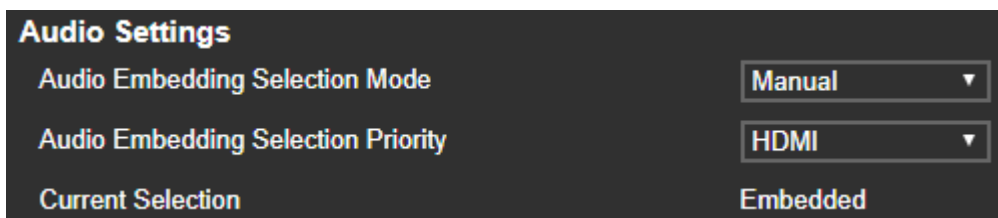

Figure 10: TP-594Txr Video and Audio Page – HDMI Audio to Receiver Settings

5. In the TP-594Rxr Navigation pane ([Figure 30](#)), click **Video & Audio**. The Video and Audio settings page appears ([Figure 40](#)).

6. Under Audio Settings ([Figure 11](#)):

- Set Audio De-embedding Source to **Line-HDMI IN**.
- Set Audio De-embedding Destination to **Analog OUT**.



When Audio De-embedding Source and/or Destination are set to **None**, the AUDIO analog out port is muted.



Figure 11: TP-594Rxx Video and Audio Page – HDMI Audio to Receiver Settings



If ARC Output Source ([Figure 40](#)) is set to **Analog IN**, the above settings are automatically set to **None** and analog output is disabled (see [Setting Audio Signal Sources and Destinations](#) on page [36](#)).

The TP-594Txx HDMI audio input is routed to the TP-594Rxx HDMI and analog audio outputs.

Routing Priority-Selected Audio Source to Receiver

To set a priority-selected analog audio source automatically:

1. Connect an analog audio source to the AUDIO 5-pin terminal block connector and/or the HDMI connector.
2. In the TP-594Txx Navigation pane ([Figure 29](#)), click **Video & Audio**. The Video and Audio settings page appears ([Figure 39](#)).
3. Under Audio Settings ([Figure 12](#)):
 - Set Audio Embedding Selection Mode to **Auto**.
 - Set Audio Embedding Selection Priority to **Analog/HDMI**.
In this example, the audio embedding source priority is set to analog; if the HDMI source is connected and the analog audio source is then connected, the audio embedding source switches automatically to analog.
 - View the active audio Current Selection (Embedded in this example).



When AUDIO on the TP-594Txx is set to **Analog**, ARC cannot be output via the analog AUDIO port.

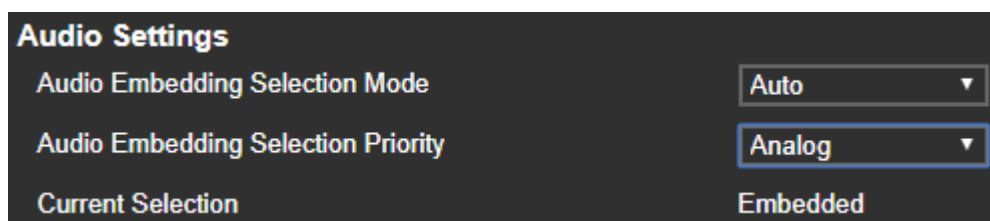

Figure 12: TP-594Txx Video and Audio Page – Auto Priority Audio Settings

4. In the TP-594Rxx Navigation pane ([Figure 30](#)), click **Video & Audio**. The Video and Audio settings page appears ([Figure 40](#)).

5. Under Audio Settings ([Figure 13](#)):

- Set Audio De-embedding Source to **Line-HDMI IN**.
- Set Audio De-embedding Destination to **Analog OUT**.



When Audio De-embedding Destination is set to None, the AUDIO analog port is muted.



Figure 13: TP-594Rxr Video and Audio Page – Auto Priority Audio Settings



If ARC Output Source is set to **Analog IN**, the above settings are automatically set to **None** and analog output is disabled (see [Setting Audio Signal Sources and Destinations](#) on page [36](#)).

The TP-594Txx priority audio source is routed to the TP-594Rxx HDMI and analog audio outputs.

Routing Analog Audio Source to Receiver for Auto-play when Video Signal is Unavailable

To route the analog audio source to the receiver without video signal display:

1. Connect an audio source to the AUDIO 5-pin terminal block connector.
2. Mute or disconnect the HDMI source connected to the HDMI connector.
3. In the TP-594Txx Navigation pane ([Figure 29](#)), click **Video & Audio**. The Video and Audio settings page appears ([Figure 39](#)).
4. Under Video Settings ([Figure 14](#)):
 - Set Analog Audio Auto-play Upon No Video Signal to **On**.

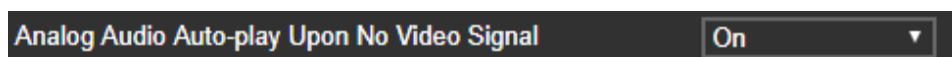

Figure 14: TP-594Rxx Video and Audio Page – Audio Auto-play Set to On

5. Under Audio Settings ([Figure 15](#)):

- Set Audio De-embedding Source to **Manual**.
- Set Audio De-embedding Destination to **Analog**.
- View the active audio Current Selection (**Analog** in this example).



When the Audio Embedding Selection Priority on the TP-594Txx is set to **Analog**, ARC cannot be output via the analog AUDIO port.

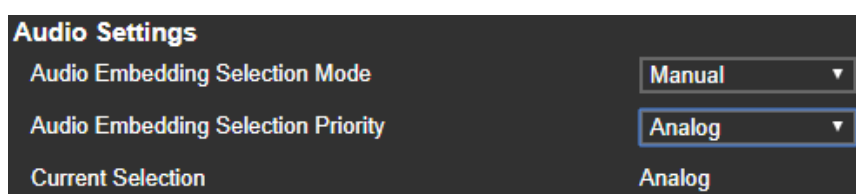

Figure 15: TP-594Txx Video and Audio Page – Analog Audio to Receiver Settings (no HDMI signal)

6. In the **TP-594Rxx** Navigation pane, click **Video & Audio**. The Video and Audio settings page appears.
7. Under Audio Settings ([Figure 16](#)):
 - Set Audio De-embedding Source to **Line-HDMI IN**.
 - Set Audio De-embedding Destination to **Analog OUT**.



When Audio De-embedding Source/Destination is set to **None**, the analog AUDIO port is muted.



Figure 16: TP-594Rxx Video and Audio Page – Analog Audio to Receiver Settings



If ARC Output Source is set to **Analog IN**, the above settings are automatically set to **None** and analog output is disabled (see [Setting Audio Signal Sources and Destinations](#) on page [36](#)).

The **TP-594Txx** analog audio input is routed to the **TP-594Rxx** analog audio output and played on its connected speakers with a black screen on the display.

Routing TP-594Rxx Audio Signals

TP-594Rxx provides several audio sources that are defined via the web pages: the HDMI OUT ARC, the TOSLINK IN digital input or Analog AUDIO defined as an input.

After defining the ARC source (see [Defining the ARC Source](#) on page [16](#)), perform the following operations:

- [Routing HDMI-out ARC signal to AUDIO on TP-594Rxx](#) on page [17](#).
- [Routing Audio Return Signals on TP-594Txx](#) on page [17](#).

Defining the ARC Source

To define the ARC signal source:

1. In the **TP-594Rxx** Navigation pane, click **Video & Audio**. The Video and Audio settings page appears.
2. Select one of the following source options:
 - HDMI-out ARC.
 - Analog IN (defines the AUDIO port on **TP-594Rxx** as an input, otherwise defined as an output).
 - Digital IN (refers to the TOSLINK IN port).

Routing HDMI-out ARC signal to AUDIO on TP-594Rxr

The HDMI-out ARC signal can be routed to the analog balanced stereo AUDIO port.

To route the HDMI OUT ARC signal to the analog AUDIO port on TP-594Rxr:

1. Connect the TP-594Rxr HDMI OUT connector to an acceptor (for example, a smart TV).
2. In the TP-594Rxr Navigation pane, click **Video & Audio**. The Video and Audio settings page appears.
3. Under Audio Settings ([Figure 17](#)):
 - Set ARC Output Source to **HDMI-out ARC**.
 - Set Audio De-embedding Source to **HDMI-out ARC**.
 - Set Audio De-embedding Destination to **Analog OUT**.

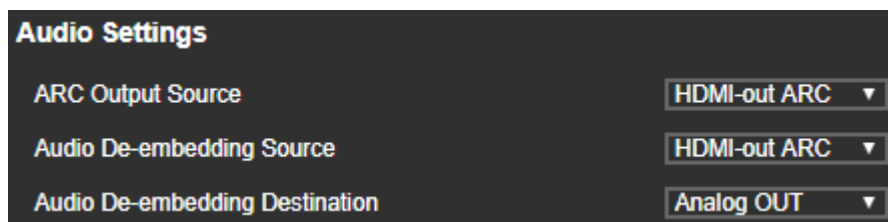

Figure 17: TP-594Rxr Video and Audio Page – Routing ARC to TP-594Rxr Analog Audio

HDMI OUT ARC is routed to the AUDIO analog port on the TP-594Rxr and to the TP-594Txr via the HDBT link.

Routing Audio Return Signals on TP-594Txr

The following audio ports accept ARC on the transmitter:

- HDMI IN.
- AUDIO.
- TOSLINK OUT.

The ARC signals are defined in the TP-594Rxr Video & Audio web page (see [Setting Audio Signal Sources and Destinations](#) on page 36) and extended via HDBT to their destination ports on TP-594Txr.

To route an ARC signal to the AUDIO port on TP-594Txr:

1. In the **TP-594Rxr** Navigation pane, click **Video & Audio**. The Video and Audio settings page appears ([Figure 29](#)).
2. Define the ARC signal source on **TP-594Rxr** (see [Defining the ARC Source](#) on page [16](#)), **HDMI-out ARC** in this example ([Figure 18](#)).

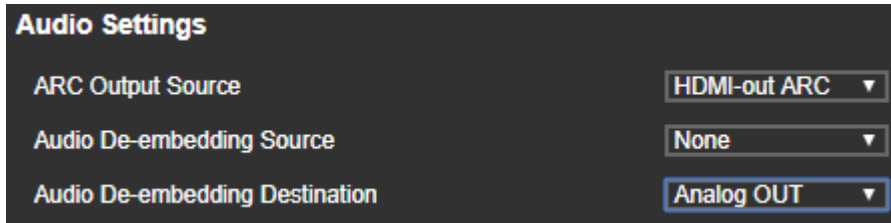

Figure 18: TP-594Rxr Video and Audio Page – Setting HDMI-out ARC

The **TP-594Txr** received ARC signal is routed to the HDMI IN and analog audio outputs according to the **Audio Line-ARC Extraction Destination** (see [Setting Audio Parameters](#) on page [34](#)).

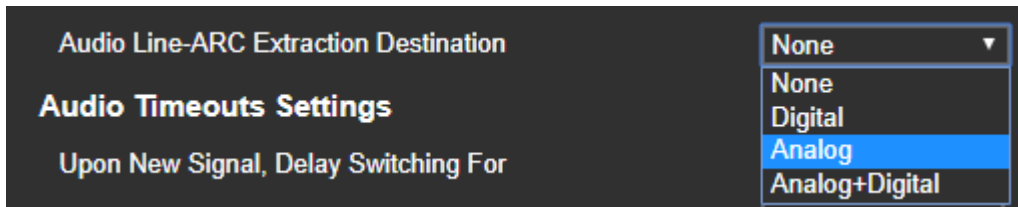

Figure 19: Setting Audio Line-ARC Extraction Destination on TP-594Txr



When in **TP-594Rxr** Audio De-embedding Destination is set to **Analog OUT**, the **TP-594Txr** analog AUDIO port should not be connected to an analog audio source.

Extending and Routing Control Signals

TP-594Txr and TP-594Rxr control signals can be extended in the following ways:

- [Extending Control Signals via HDBT](#) on page 19.
- [Extending HDMI CEC Commands](#) via HDMI Connections on page 20.
- [Routing IP-Driven Control Signals via Built-in Control Gateway](#) on page 21.

Extending Control Signals via HDBT

Ethernet, RS-232 and IR control commands can be extended bidirectionally between the TP-594Txr and TP-594Rxr transmitter and receiver system, enabling the user to control peripheral devices connected to far-end devices.

The example in [Figure 20](#) shows:

- RS-232 signal extension – Serial control signals are extended, via HDBT, between the **SL-240C** that is connected to the RS-232 port on the transmitter side, and the RS-232 port on the receiver side that is connected to the smart TV.
- IR signal extension – The smart TV IR remote control unit sends an IR command signal via an IR sensor cable that is connected to the transmitter side. This signal is extended via HDBT to the receiver side and is transmitted to the smart TV via an IR emitter cable.
- Ethernet extension – IP control signals are extended, via HDBT, between the **SL-240C**, that is connected to the ETH port on the transmitter side, and the **FC-7** that is connected to the ETH port on the receiver side. **FC-7** relays are connected to the blinds.

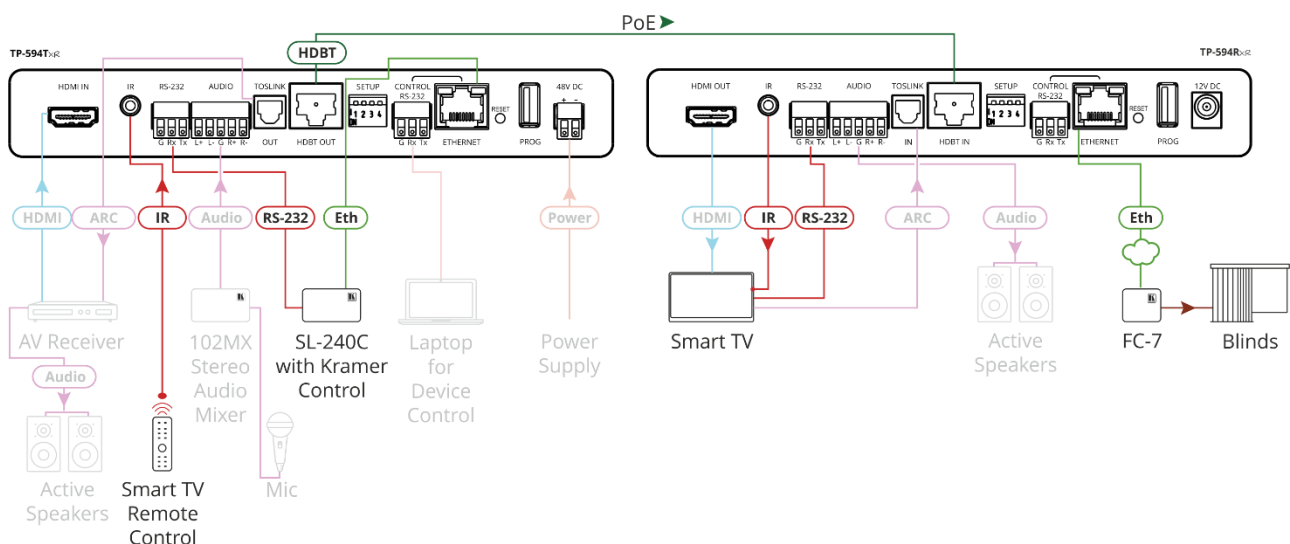

Figure 20: Extending Control Signals via HDBT

Extending HDMI CEC Commands via HDMI Connections

CEC enables the user to control all HDMI connected devices. In the extender (transmitter receiver) system, all the connected HDMI devices can communicate to each other, via standard HDMI-embedded CEC control channel, allowing control of one HDMI-connected device by another.

The example in [Figure 21](#) shows an AV receiver on the transmitter side and a smart TV on the receiver side, connected via HDMI, both CEC-enabled. The IR remote control unit that points to the smart TV can send commands, such as audio mute or volume up/down, to control either the smart TV and/or the AV receiver on the transmitter side, via the end-to-end CEC control channel, extended over the HDBT link.

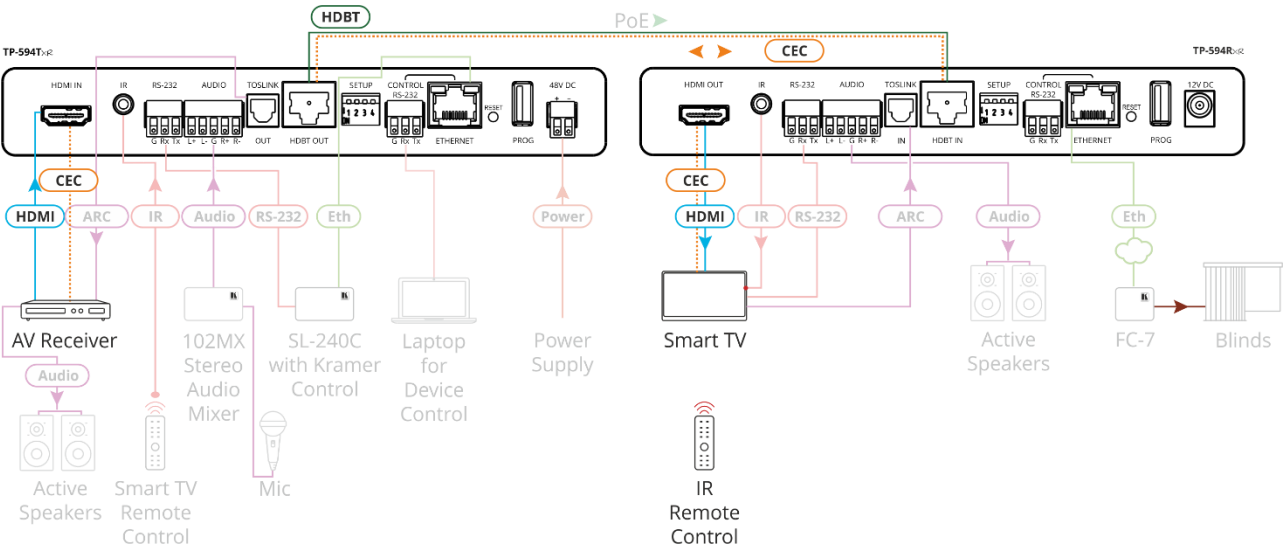

Figure 21: CEC End-to-End Extension

Routing IP-Driven Control Signals via Built-in Control Gateway

Remote IP connected clients can send from the LAN, via the **TP-594Rxr** built-in control gateway, CEC, RS-232 and IR commands, to control devices connected to **TP-594Rxr** HDMI-CEC, RS-232 and IR control ports. The built-in control gateway sends the control commands (converted from the client received IP messages) to the connected controlled devices, and distributes the responses received from the connected controlled devices to all connected clients.

[Figure 22](#) shows the **TP-594Rxr** built-in control gateway connection. On the transmitter, **KT-107** (with Kramer Control) is connected to the Ethernet port via LAN. **KT-107** sends IP commands to the receiver control gateway, over the HDBT LAN connection, to send control messages to, and receive control responses from:

- The smart TV connected to the receiver via either the IR, RS-232 and/or HDMI (CEC) ports.
- The AV Receiver connected to the transmitter via the HDMI (CEC) port.

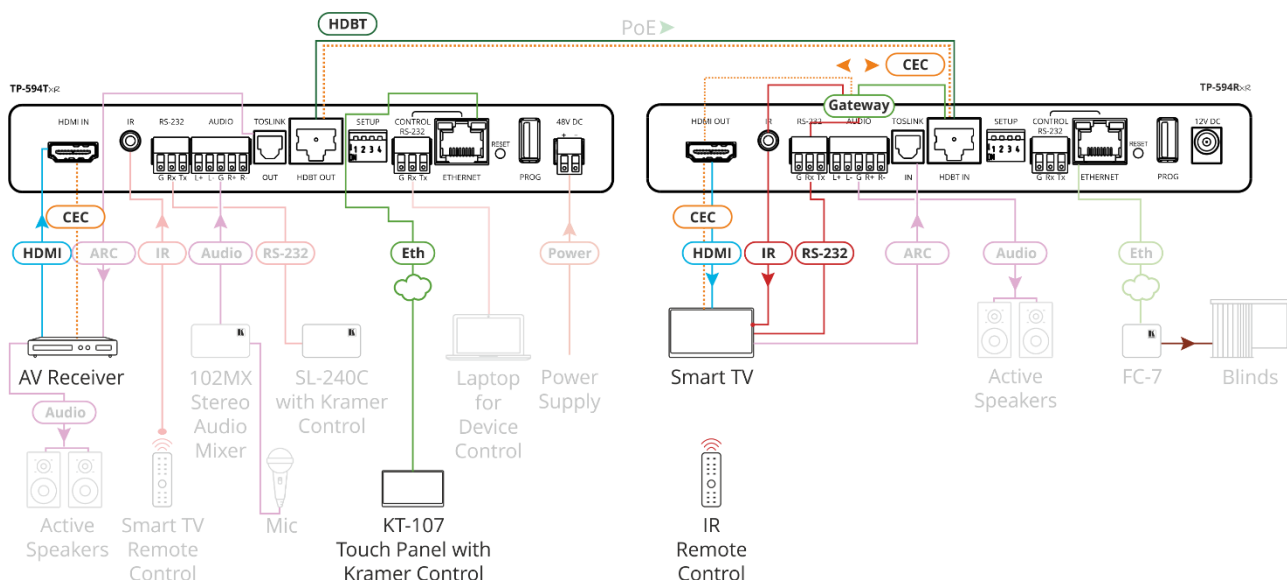

Figure 22: Extending Signals via Control Gateway

Built-in control gateway enable/disable activation, enable/disable activation of the associated control ports, and the control gateway CEC configuration (such as the CEC logical address of the control gateway), as well as its manual commands sending operation, is done via **TP-594Rxr** control gateway webpages (see [Defining TP-594Rxr Gateway and Ports Activation](#) on page [38](#)).

Operating and Controlling TP-594Txr and TP-594Rxr

This section describes the following actions:

- [Setting DIP-Switches](#) on page [22](#).
- [Operating via Ethernet](#) on page [23](#).

Setting DIP-Switches

The four DIP-switches located on the back panel are used for setting the range mode, IR modulation and EDID setup. By default, all DIP-switches are set to Off except for DIP-switch 1 which is set to ON by default.

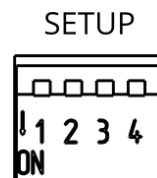





Figure 23: DIP-Switches

#	Function	Status
1	Range Mode	Off (up)—HDBaseT ultra-long range (provides increased range at a reduced bandwidth). On (down)—Normal range.  The ultra-long range mode is activated when DIP-switch 1, on at least one of the devices, is set to ON.
2	IR Pass-through	OFF (up)—Add IR 38kHz modulation to the IR output signal (applies only when the IR port is connected to an IR emitter cable). ON (down)—Pass-through the modulated IR signal to the IR port via IR cable.  The IR pass-through DIP-switch setup depends on the IR control configuration. We recommend that you test which position best suits your application.
3	EDID lock	Off (up)—EDID is acquired automatically. On (down)—EDID locks the current EDID so that changes on the output do not result in changes to the EDID.  EDID remains locked to auto-EDID changes when replacing the display device, for example, and does not apply to manual EDID changes such as EDID Designer EDID setup and EDID changes due to panel keys/switches user changes.
4	N/A	



The unit must be powered off and on for the new settings to activate.

Operating via Ethernet

You can connect to the **TP-594Txr** via Ethernet using either of the following methods:

- Directly to the PC using a crossover cable (see [Connecting Ethernet Port Directly to PC](#) on page 23).
- Via a network hub, switch, or router, using a straight-through cable (see [Connecting the Ethernet Port via a Network Hub or Switch](#) on page 24).

Note: If you want to connect via a router and your IT system is based on IPv6, speak to your IT department for specific installation instructions.

Connecting Ethernet Port Directly to PC

You can connect the Ethernet port of the **TP-594Txr** directly to the Ethernet port on your PC using a crossover cable with RJ-45 connectors.



This type of connection is recommended for identifying the **TP-594Txr** with the factory configured default IP address

After connecting the **TP-594Txr** to the Ethernet port, configure your PC as follows:

1. Click **Start > Control Panel > Network and Sharing Center**.
2. Click **Change Adapter Settings**.
3. Highlight the network adapter you want to use to connect to the device and click **Change settings of this connection**.

The Local Area Connection Properties window for the selected network adapter appears.

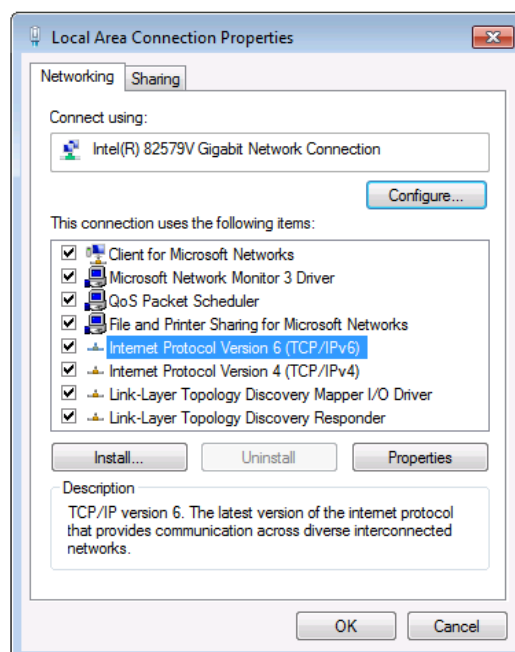

Figure 24: Local Area Connection Properties Window

4. Highlight **Internet Protocol Version 4 (TCP/IPv4)**.

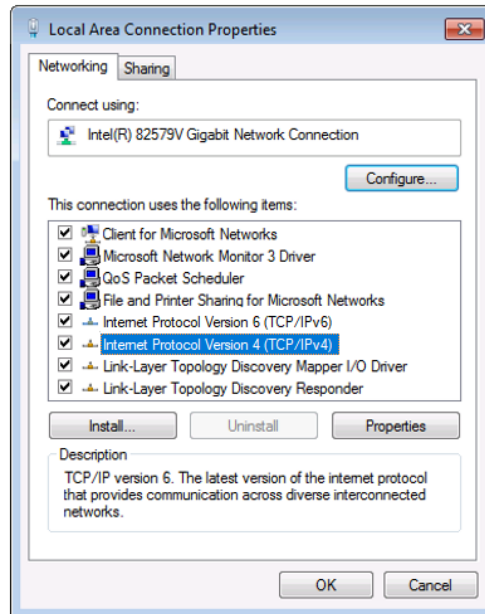

Figure 25: Local Area Connection Properties – Version 4

5. Click **Properties**.
The Internet Protocol Properties window.

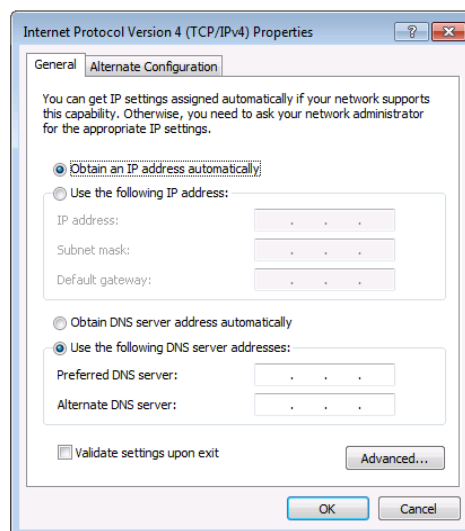

Figure 26: Internet Protocol Version 4 Properties Window

6. Select **Obtain an IP address automatically** for dynamic IP addressing allocation, and use any IP address that is provided by your IT department DHCP server.
7. Click **OK**.
8. Click **Close**.

Connecting the Ethernet Port via a Network Hub or Switch

You can connect the Ethernet port of the **TP-594Txr** to the Ethernet port on a network hub or using a straight-through cable with RJ-45 connectors.

Configuring the Ethernet Port

You can set the Ethernet parameters via the embedded Web pages (see [Using the Embedded Web Pages](#) on page 25).

Using the Embedded Web Pages

Use the embedded web pages to operate **TP-594Txr** and **TP-594Rxr** remotely. You can view both web pages when they are connected to each other via HDBT and at least one of them is connected to the Ethernet.

The web pages are accessed using a Web browser and an Ethernet connection.

 In this section, **TP-594Txr** web pages are used to describe both devices' pages except when there are differences, which are described separately.

Before attempting to connect:

- Perform the procedures in [Configuring the Ethernet Port](#) on page [24](#).
- Ensure that your browser is supported.

The following operating systems and Web browsers are supported:

Operating Systems	Versions
Windows 7	IE
	Firefox
	Chrome
	Safari
Windows 10	IE
	Edge
	Firefox
	Chrome
Mac	Safari
iOS	Safari

 Some features might not be supported by some mobile operating systems.

Browsing Web Pages

By default, both devices are set to DHCP.



Figure 27: Using the Embedded Web pages – Default IP Address

 Each device has its own unique web page.

To browse the Web pages:

1. Open your browser:
 - When DHCP is ON – Access the web page for each device by entering the device name in the address bar of your browser.

- When DHCP is OFF – Enter the IP address of the device in the address bar of your browser.



If the page is not secured, it appears when entering the device name or IP address.

2. If the page is secured, once you enter the device name/IP address, the Authentication window appears:

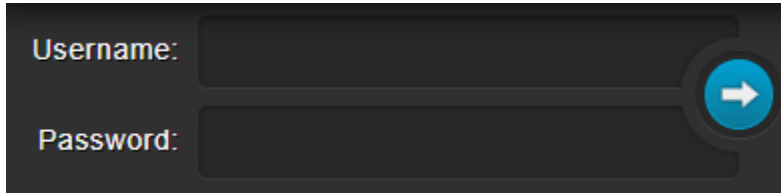

Figure 28: Using the Embedded Web Pages – Authentication Window

3. Enter the Username and Password (Admin, Admin by-default) and click the arrow button.

The General Info page appears:

- For **TP-594Txr**:

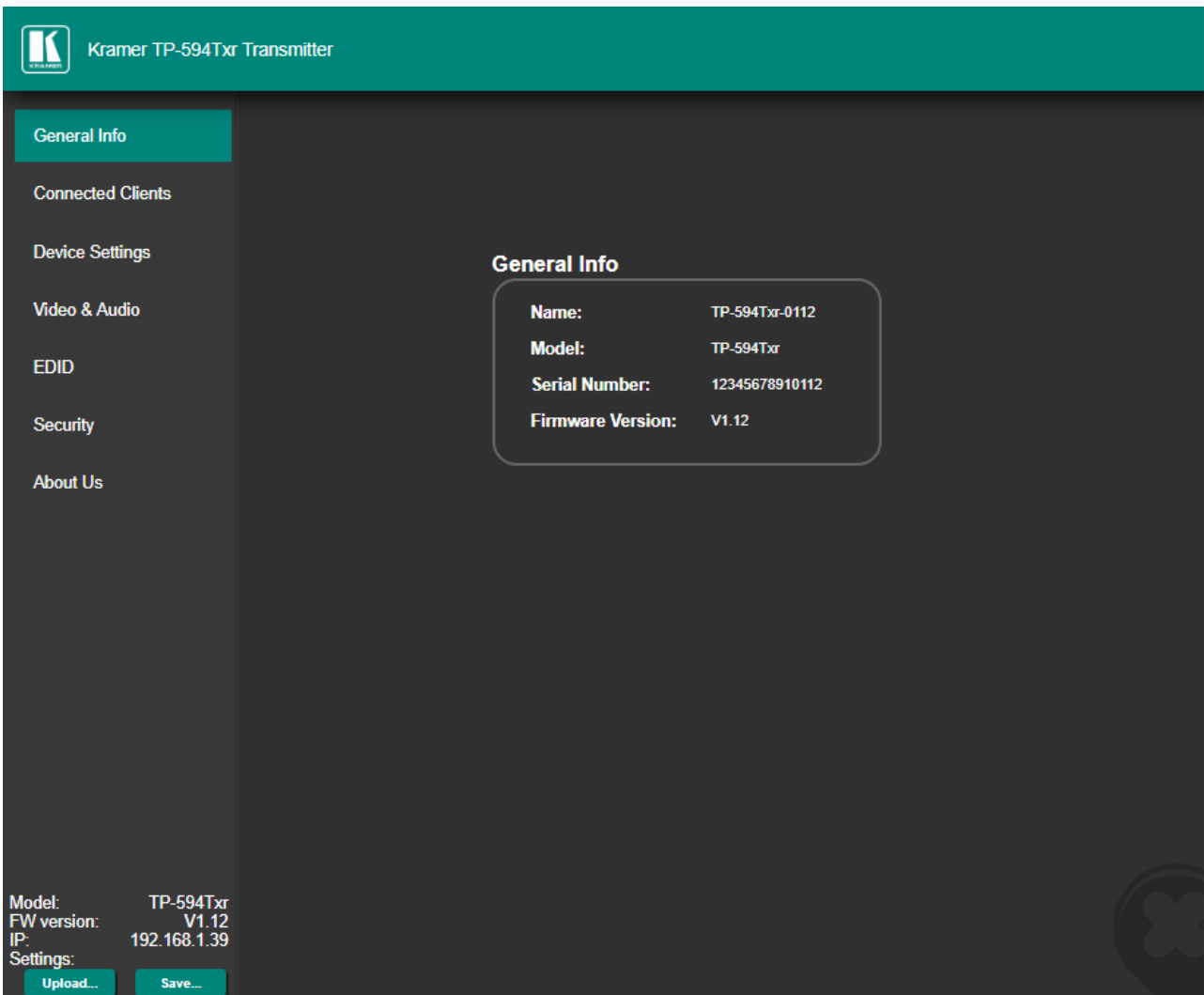

Figure 29: TP-594Txr Routing Settings Page with Navigation List on Left

- For TP-594Rxr:

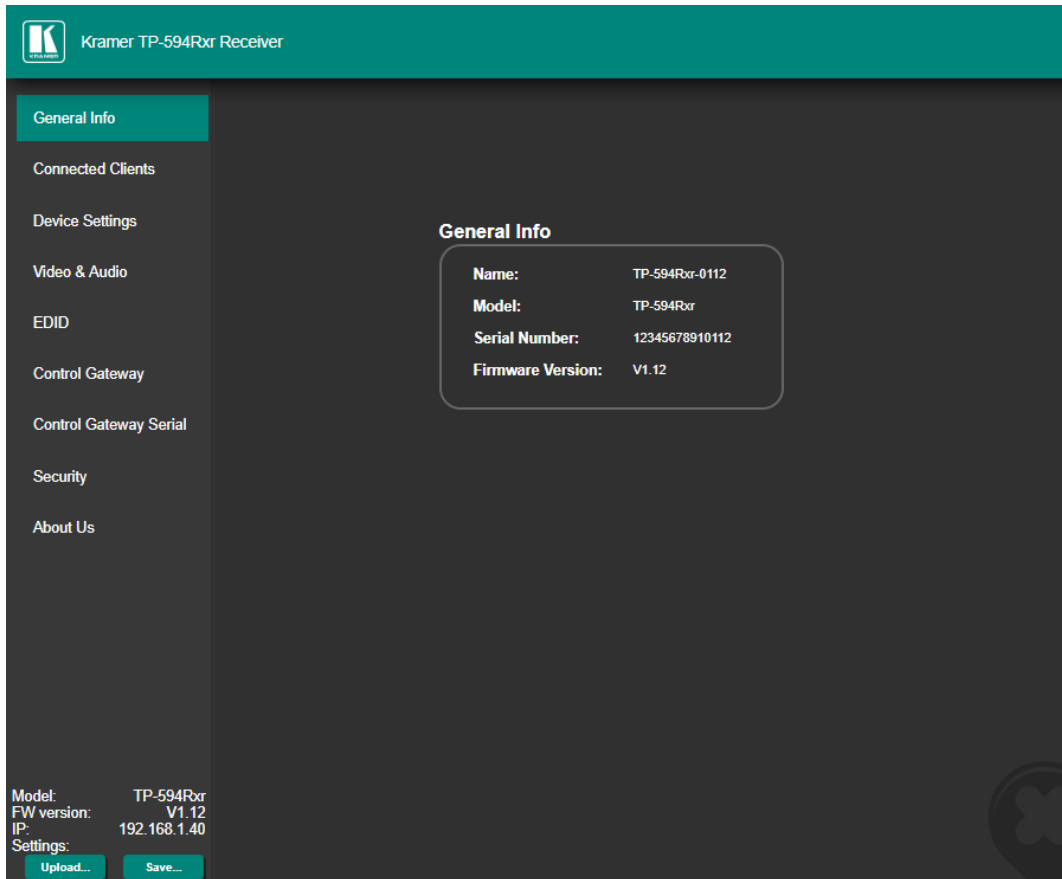

Figure 30: TP-594Rxr Routing Settings Page with Navigation List on Left



Items in the navigation pane list that are identical for both devices are described together. Unique items for each device are described separately.

4. Click the desired item in the navigation pane.



The model name, FW version and IP address appear on the lower left side of the main page. The lower part of the screen lets you save the settings and upload a saved setting.

The TP-594Txr and TP-594Rxr web pages enable performing the following functions:

- [Viewing General Information](#) on page [28](#).
- [Viewing Connected Clients](#) on page [28](#).
- [Changing Device Settings](#) on page [29](#).
- [Defining TP-594Txr Video and Audio Settings](#) on page [33](#).
- [Defining TP-594Rxr Video and Audio Settings](#) on page [35](#).
- [Managing EDID](#) on page [36](#).
- [Defining TP-594Rxr Gateway and Ports Activation](#) on page [38](#).
- [Defining TP-594Rxr Gateway Serial Port Settings](#) on page [41](#).
- [Setting Web Page Access Permission](#) on page [42](#).
- [Viewing About Page](#) on page [44](#).

Viewing General Information

The General Info page displays the name and model of the **TP-594Txr / TP-594Rxr** as well as its serial number and firmware version.

To view general information:

1. in the Navigation pane, click **General Info**. The General Info page opens.



Figure 31: General Info Page

Viewing Connected Clients

Up to 4 connected TCP clients and 4 connected UDP clients can be IP-connected to **TP-594Txr / TP-594Rxr** control gateway for simultaneous control of the device itself as well as peripheral devices such as projectors, displays and DVD players.

To view the connected clients list:

1. In the Navigation pane, click **Connected Clients**. The Connected Clients page opens:

The screenshot shows a dark-themed interface with a table titled "Connected Clients". The table has four columns: Client IP, Client Port, Protocol, and Port. It lists three active connections.

Client IP	Client Port	Protocol	Port
192.168.1.10	50609	TCP	5000
192.168.1.12	62254	UCP	50000
192.168.1.41	62236	TCP	5001

Figure 32: Connected Clients Page

The Connected Clients page displays the following information:

- Client IP lists the IP addresses of the connected clients (for example, your PC, an IP-enabled controller and so on).
- Client Port lists the client IP protocol port number used for the connection.
- Protocol lists the client IP protocol type (TCP or UDP) used for the connection.
- Port lists the TP-594Txr / TP-594Rxr IP protocol port number used for the connection.



Set the TP-594Txr / TP-594Rxr port number via the Device Settings page ([Changing the IP Settings](#) on page 30) and set the control gateway port numbers for TP-594Rxr via (see [Defining TP-594Rxr Gateway Serial Port](#) Settings on page 41).

Changing Device Settings

Use the Device Settings page to change the TP-594Txr / TP-594Rxr name (then click **SET**) and perform the following operations:

- [Changing the IP Settings](#) on page 30.
- Viewing the HDBT range mode status as defined by DIP-switch 1 (see [Setting DIP-Switches](#) on page 22).
- [Upgrading the Firmware](#) on page 31.
- [Soft Factory](#) Reset on page 32.

Changing the IP Settings

To change the IP settings:

1. In the Navigation pane, click **Device Settings**. The Device Settings page appears:

Figure 33: Device Settings Page

2. Check/uncheck the **DHCP** box **ON** (default) or **OFF**.

When DHCP is checked:

- IP Address shows the device-acquired IP address (from the DHCP server).
- Static IP Address, Gateway and Subnet are disabled.



Static IP Address is the actual IP address when operating in non-DHCP mode and is also the fallback IP address, auto-acquired after no DHCP server detection. Defaults are set to:

- TP-594Txr: 192.168.1.39.
- TP-594Rxr: 192.168.1.40.

The confirmation window appears:

Figure 34: Device Settings Page – Changing to DHCP Mode

3. Click **OK**.
4. If DHCP is **OFF**, change any of the static IP parameters (Static IP Address, Netmask and/or Gateway).
5. Click **Set Changes**.



- After changing the IP Address, or DHCP to ON, reload the Web page with the new IP address.
- After changing the Subnet mask, turn the **TP-594Txr / TP-594Rxr** power off and then on again.

Any change in the device settings requires confirmation, as illustrated in the example in [Figure 35](#).

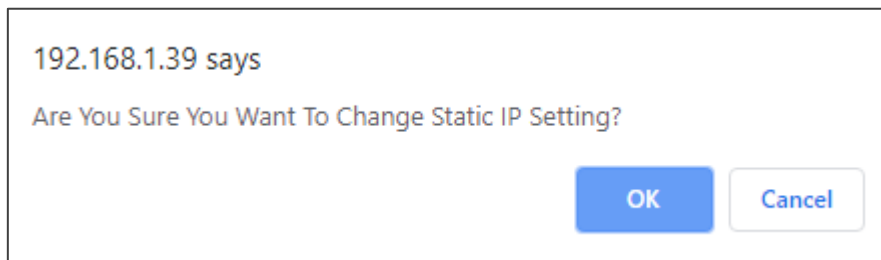

Figure 35: The Device Settings Page – Static IP Setting Confirmation

6. Click **OK**.
Ethernet parameters are changed.

Viewing HDBaseT Settings

HDBaseT range is set by DIP-switch 1 (see [Setting DIP-Switches](#) on page 22).

HDBT Extra Range displays the extra range status as set by the DIP-switch (ON/OFF).

Upgrading the Firmware

To upgrade the firmware:

1. In the Navigation pane, click **Device Settings**. The Device Settings page appears.
2. Click **Choose File** in the Firmware update line. An Open window appears.
3. Select the correct firmware file from the PC that is connected to the device.



Each device has its own firmware file.

4. Click **Open**. The selected file appears in the **Firmware Update** line.

5. Click **Upgrade**.

The new firmware is uploaded, the firmware is upgraded and the system restarts. Upon completion, the web page refreshes.

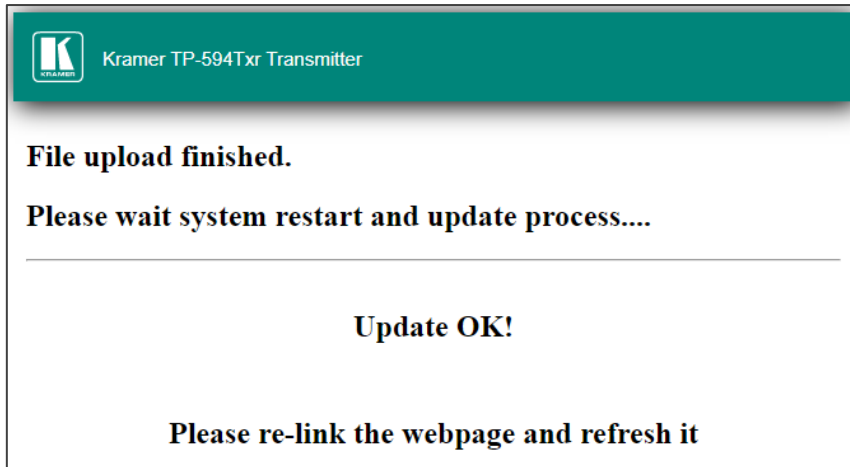

Figure 36: The Device Settings Page – Uploading the New Firmware File

6. Make sure that the new version appears on the Web page lower left side:

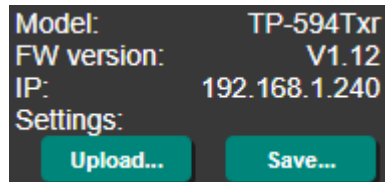

Figure 37: The Device Settings Page – New Firmware Updated

Soft Factory Reset

To reset the device to its factory default parameters (except for IP parameters):

1. In the Navigation pane, click **Device Settings**. The Device Settings page appears.
2. Click **Soft Factory reset**. The following message appears:

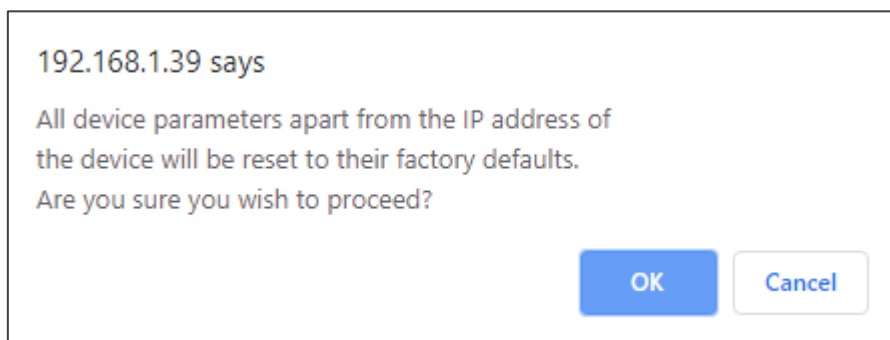

Figure 38: Device Settings Page – Soft Factory Reset Message

3. Click **OK** and wait for the web page to reload following soft factory reset.



See [Default Communication Parameters](#) on page [48](#) to view other factory reset procedures.

Defining TP-594Txr Video and Audio Settings

The TP-594Txr enables performing the following:

- [Setting Input Video Parameters](#) on page 33.
- [Setting Audio Parameters](#) on page 34.

Setting Input Video Parameters

To set the input video parameters:

1. In the Navigation pane, click **Video & Audio**. The Video and Audio settings page appears.

Video & Audio

Video Settings

HDCP Input Status: OFF

HDCP Mode:

DSC Compression:

Analog Audio Auto-play Upon No Video Signal:

Video Timeouts Settings

Upon Signal Loss, Delay 5V Power Off For: second

Upon New Signal, Delay Switching For: second

Upon Signal Loss, Delay Switching (& Leave 5V ON) For: second

Upon Cable Unplug, Delay Switching For: second

Audio Settings

Audio Embedding Selection Mode:

Audio Embedding Selection Priority:

Current Selection: Embedded

Active Audio Signal Detection Sensitivity Level:

Audio Line-ARC Extraction Destination:

Audio Timeouts Settings

Upon New Signal, Delay Switching For: second

Upon Signal Loss, Delay Switching (& Leave 5V ON) For: second

Figure 39: TP-594Txr Video & Audio Page

2. View the HDCP Input status.
Once an input is connected, TP-594Txr automatically detects input signal HDCP status.
3. Set the following:
 - **Enable** (default) or **Disable** HDCP Mode for HDCP support on the HDMI input.
 - **Enable** (default) or **Disable** DSC Compression.



Display Stream Compression (DSC) enables standard visually lossless compression for 18G ultra-high definition 4K60 4:4:4 (4K HDR) HDMI signal extension over the HDBT link. When DSC is disabled, only 10G 4K60 4:2:0 HDMI signal extension is supported over the HDBT.

- Define Analog audio auto-play **On** or **Off** (default). When audio auto-play is On, and no video signal is detected, **TP-594Txr** automatically transmits, to the HDBT output, a black video signal with embedded analog audio input signal. Typically, this is used for playing background audio music/signal by the peer **TP-594Rxr** device.

4. Set Video Timeout Settings as defined in the following table:



The **Video Timeouts Settings** (excluding output inactivity) refer to the time delay to switch to analog audio when audio embedding mode is set to Auto and HDMI is set as the priority.

Timeout	Description	Range [sec]	Default [sec]	Limitation
Output inactivity: Upon Signal Loss, Delay Power Off	When the signal is lost, delay 5V power off (on the receiver side) for x seconds	5 to 60000	900	Output inactivity timeout > Input unplug timeout
This timeout setting is valid only when the receiver side does not have this timeout setting.				
Signal detected: Upon New Signal, Delay Switching	When a new HDMI signal is detected while the analog audio input is active, delay the switching from analog audio input to the HDMI embedded audio.	0 to 90	0	None
Signal loss: Upon Signal Loss, delay switching (& Leave 5V ON)	When the signal is lost either because the source is on standby or in the sleep mode, delay the switching to analog audio input.	5 to 90	10	Signal loss timeout < Output inactivity timeout
Input unplug: Upon Cable Unplug, Delay Switching	When the signal is lost because the source is disconnected, delay the switching to analog audio input.	0 to 90	0	Input unplug timeout ≤ Output inactivity timeout

Setting Audio Parameters

To set the input audio features:

1. In the Navigation pane, click **Video & Audio**. The Video and Audio settings page appears.
2. Select the audio embedding mode to **Manual** (default) or **Auto**.
3. If audio embedding is set to Auto, set the audio embedding priority to **HDMI** (default) or **Analog**.
4. Select the audio signal detection level (-45dBFS, by default) to determine the signal detection sensitivity level.
Signal detection level ranges from -57dBFS (highest sensitivity) to -20dBFS (lowest sensitivity).

- Select the audio port to which the ARC signal (passing from the receiver via the HDBT) is de-embedded to (while also routed to the HDMI IN port): Analog (AUDIO), Digital (TOSLINK OUT) or both.

ARC source is set in the receiver web page (see [Setting Audio Signal Sources and Destinations](#) on page 36).



For further information regarding routing audio signals, see [Routing Audio Signals](#) on page 12.

- Set the audio timeouts according to the information in the following table:

Timeout	Description	Range [sec]	Default [sec]	Limitation
Signal detected: Upon New Signal Delay Switching	When a new analog audio signal is detected, delay the switching from HDMI to the analog audio input embedding.	0 to 90	0	None
Signal loss: Upon signal loss, Delay Switching (& Leave 5V ON)	When the analog audio signal is lost, delay the switching to HDMI audio.	60 to 180	60	None



The **Audio Timeout Settings** refer to the time delay to switch to HDMI audio when audio embedding is set to Auto and Analog is set as the priority.

Defining TP-594Rxr Video and Audio Settings

The Video and Audio settings page enables performing the following functions:

- [Setting Input Video Parameters](#) on page 33.
- [Setting Audio Parameters](#) on page 34.

Setting Video Parameters

To set the input video parameters:

- In the Navigation pane, click **Video & Audio**. The Video and Audio settings page appears.

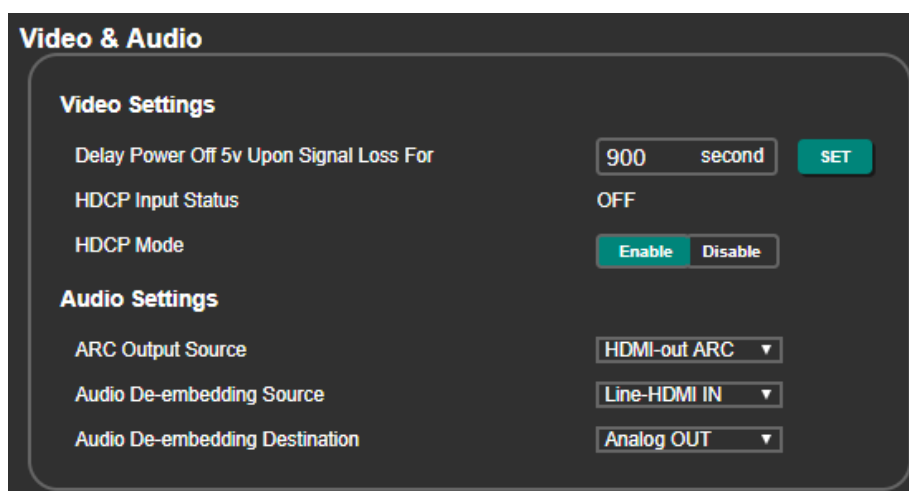

Figure 40: TP-594Rxr Video & Audio Page

2. Set the 5V power off delay timeout (on the receiver side) when the signal is lost, for x seconds (5 to 60000 seconds, 900 seconds by default).



This timeout setting is valid only when the transmitter side does not have this timeout setting.

3. View the HDCP input status.
Once an input is connected, **TP-594Rxr** automatically detects the input signal's HDCP status.
4. **Enable** (default) or **Disable** HDCP mode support on the HDMI input. This allows the source to transmit a non-HDCP signal if required (for example, when a Mac computer is connected to the transmitter side).

Setting Audio Signal Sources and Destinations

To set the input audio features:

1. In the Navigation pane, click **Video & Audio**. The Video and Audio settings page appears.
2. Select the ARC signal source for extension:
 - **HDMI-out ARC** – Select the audio return signal on HDMI OUT.
 - **Analog IN** – Select the input signal on the **TP-594Rxr** AUDIO 5-pin terminal block connector.
 - **Digital IN** – Select the TOSLINK IN input signal.
 - **None** – Do not select ARC.
3. Select the audio de-embedding source for analog audio output:
 - **Line-HDMI IN** – From the HDMI IN on the transmitter via HDBT (line).
 - **HDMI-out ARC** – From the HDMI OUT audio return signal.
 - **None** – No de-embedding.
4. Select **Analog OUT** to route the de-embedded audio signal to the AUDIO 5-pin terminal block connector on **TP-594Rxr**. Otherwise, select **None**.



For further information regarding routing audio signals, see [Routing Audio Signals](#) on page [12](#).

Managing EDID

Use the **TP-594Txr** and **TP-594Rxr** EDID page to acquire the EDID from the output, from the default or from a custom file, and to view the current EDID lock status (see DIP-switch 3 in [Setting DIP-Switches](#) on page [22](#)).

When acquiring the EDID:

- **TP-594Txr** acquires the EDID from HDBT OUT/default/EDID file to use with HDMI IN.
- **TP-594Rxr** acquires the EDID from HDMI OUT/default/EDID file to use with HDBT IN.

To acquire the EDID from the default EDID:

- 1. In the Navigation pane, click **EDID**. The EDID management page appears.
- 2. Click **Default**.

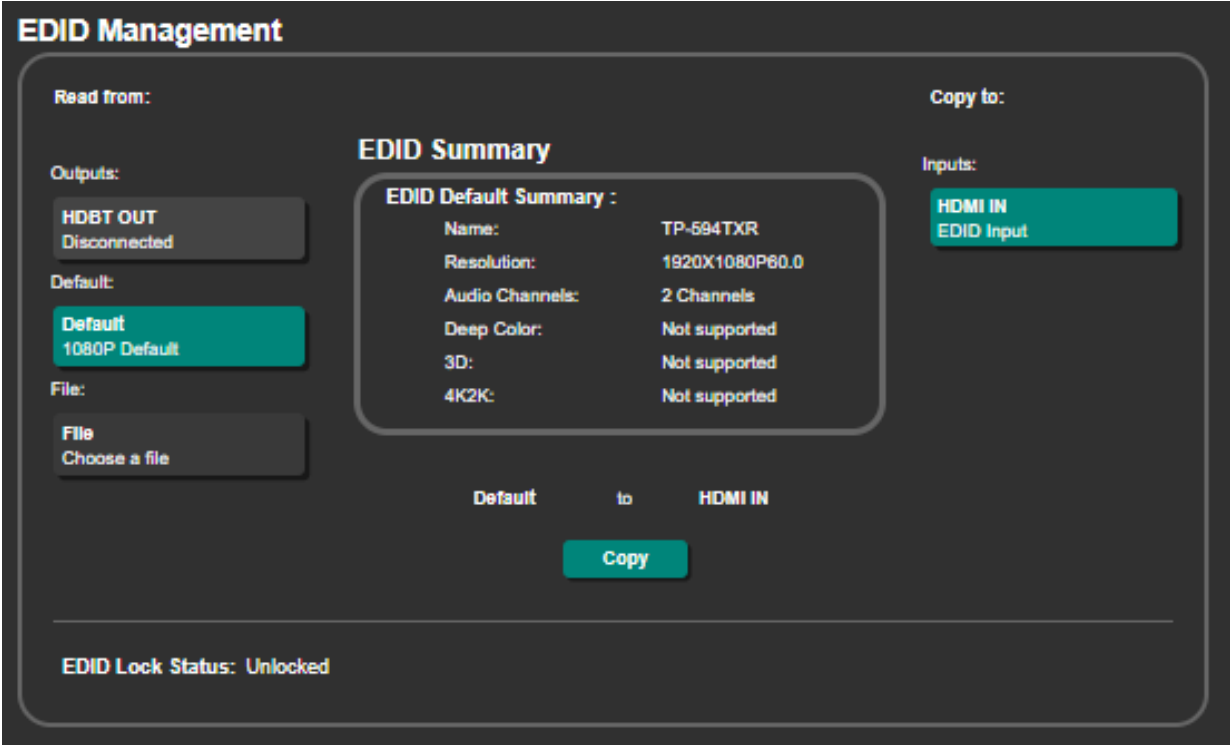

Figure 41: TP-594Txr EDID Management Page

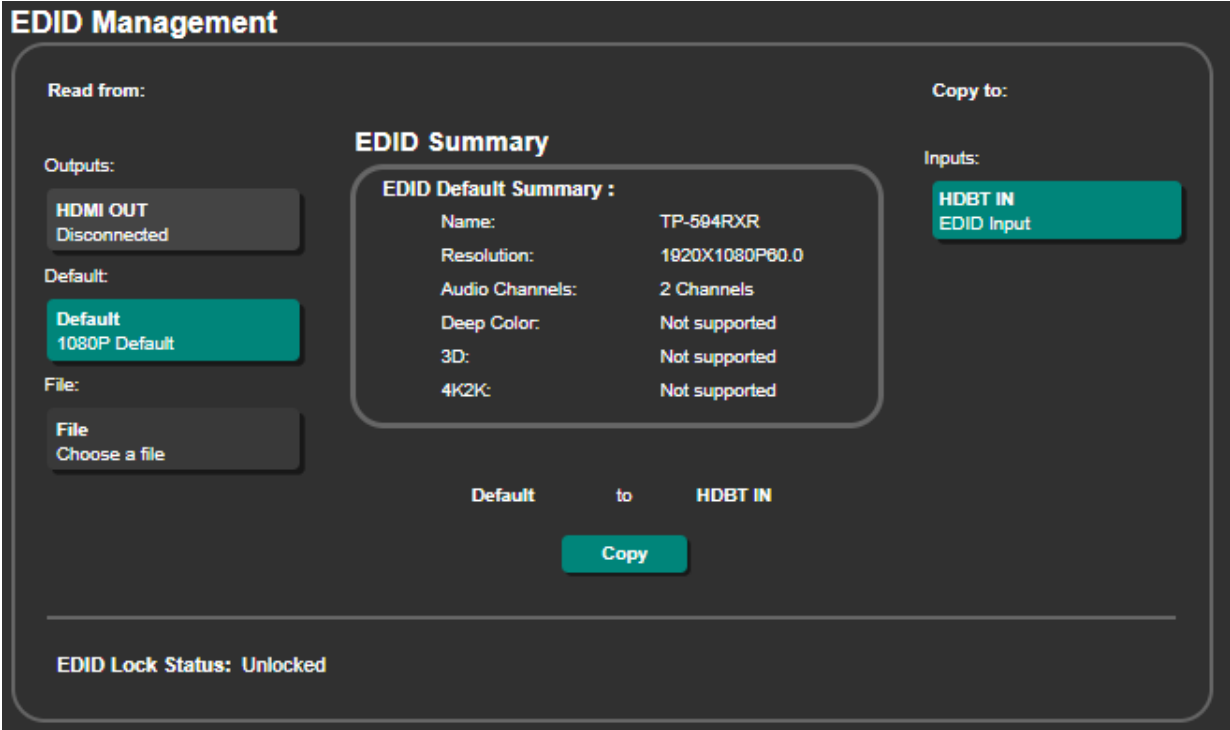

Figure 42: TP-594Rxr EDID Management Page

3. Click **Copy** and follow the instructions on-screen. A confirmation message appears.



Figure 43: EDID Confirmation Message

4. Click **OK**.
5. EDID is copied successfully.

To copy an EDID from the output to the input:

1. In the Navigation pane, click **EDID**. The EDID management page appears.
2. Select the output:
 - **TP-594Txr** – Click **HDBT OUT**.
 - **TP-594Rxr** – Click **HDMI OUT**.
3. Click **Copy**. A confirmation message appears.
4. Click **OK**.
The EDID is copied to the input.

To load a custom EDID file:

1. In the Navigation pane, click **EDID**. The EDID management page appears.
2. In the **File** area, click **Choose a file** to browse for the custom EDID file location.
3. Open the custom EDID file.
4. Click **Copy** and follow the instructions on-screen.

Defining TP-594Rxr Gateway and Ports Activation

The devices connected to the RS232/IR control ports are controlled via extended control signals from the transmitter over the HDBT link, while CEC control is done via IR remote control units of the HDMI-connected devices, either on the transmitter side or receiver side.

Use the **TP-594Rxr** Control Gateway page to either extend HDMI-CEC, RS-232 and IR commands bidirectionally via the HDBT link, or send them over the Ethernet to control peripheral devices that are connected to **TP-594Rxr**. For example, this can be used to control a display that is connected to the HDMI OUT connector via CEC commands. CEC commands and responses can be routed both via gateway and HDBT simultaneously.

To set the control gateway and control port operation modes:

1. In the Navigation pane select **Control Gateway**. The Gateway & Ports Activation page appears.

Gateway & Ports Activation

Control Gateway Status Enable Disable

RS-232 Port Commands Source Gateway HDBT-Line

IR Port Commands Source Gateway HDBT-Line

CEC Port Commands Source Gateway + HDBT-Line HDBT-Line

CEC Gateway Logical Address 14

CEC Members Logical Address List

CEC List Refresh

Manual Control

Control Port Selection RS-232

Command Status : N/A Send

Figure 44: TP-594Rxr Control Gateway & Ports Activation Page

2. In the Control Gateway Status area, click **Enable**:
 - The connected IP clients can send IP messages (see [Protocol 3000](#) on page [51](#)) to control devices connected to gateway-enabled control ports (see below IR/RS-232/CEC), and receive their control responses over the IP connection.
 - **Disable** control gateway (default).
3. Optionally, route RS-232 port control communication via **Gateway** or via **HDBT-Line** (default) extension.

 When routing commands via gateway, and sending replies to a new client is enabled (see [Defining TP-594Rxr Gateway Serial Port Settings](#) on page [41](#)), RS-232 responses are sent to other gateway Clients too.
4. Optionally, route IR port control communication via **Gateway** or **HDBT-Line** (default) extension.

- Optionally, route CEC port control communication either via **Gateway and HDBT-Line** (both are active) or only via **HDBT-Line** (default) extension (gateway CEC communication is blocked).

When CEC (HDMI) port control communication is via **Gateway**, define the following CEC-enabled control gateway attributes:

- Enter the CEC logical address (14, by default) of the control gateway.
- View the list of logical addresses for CEC-enabled devices connected on HDMI line as members of the CEC control channel.
- Click **CEC List Refresh** to update the logical address list of CEC members.



According to HDMI CEC standard, for proper identification during CEC control communication, each CEC-enabled member of the CEC control channel, is assigned a CEC logical address.

Sending Commands Manually via Gateway

TP-594Txr and TP-594Rxr enable manually controlling a peripheral device that is connected to TP-594Rxr, via RS-232, IR or HDMI-CEC control ports.



Before manually controlling via RS-232 port, you need to define it as a control gateway serial port (see [Defining TP-594Rxr Gateway Serial Port Settings](#) on page 41).

To send commands manually:

- In the Navigation pane select **Control Gateway**. The Gateway & Ports Activation page appears.
- Under Manual Control, select the Control Port (**RS-232**, **IR** or **CEC**).
- Enter a Hex command.
- Click **Send**.

The status of the command appears in the Status text box (Sent or Error).

Figure 45: TP-594Rxr Control Gateway page – Manual Control

Defining TP-594Rxr Gateway Serial Port Settings

Use the Gateway Serial Port Settings page to enable access from connected IP clients to the control gateway. This enables for sending IP messages (see [Protocol 3000](#) on page 51) to serially control the device that is connected to the TP-594Rxr RS-232 port and receive its control responses over the IP connection.

To set the gateway serial port settings:

1. In the Navigation pane select **Control Gateway Serial**. The Gateway Serial Ports Settings page appears.

Gateway Serial Port Settings

Baud Rate: 9600

Data Bits: 8

Parity: NONE

Stop Bits: 1

IP Protocol: TCP UDP

TCP Keep Alive: 60 sec

TCP Port: 5001

UDP Port: 50001

Send Replies To New Client By Default: ON OFF

Reset Ethernet Settings Set changes

Figure 46: Control Gateway Serial page

2. Define the serial port **Baud Rate**, **Data Bits**, **Parity** and **Stop Bits** (see [Default Communication Parameters](#) on page 48).
3. Select the IP connection Protocol type (TCP or UDP).
4. Set TCP Keep Alive timeout (to auto-terminate the connection if the client does not respond).
5. Enter the TCP and UDP port numbers to connect to clients.
6. Define whether a new client automatically receives control responses from RS-232 (On) or can only send control commands (Off).

The gateway serial port is defined.

Setting Web Page Access Permission

By default, the Web pages are secured and require access permission (user name and password are both: **Admin**). This section describes how to change the password and disable/enable access permission.

To change the password:

1. In the Navigation pane, click **Security**. The Security page appears.

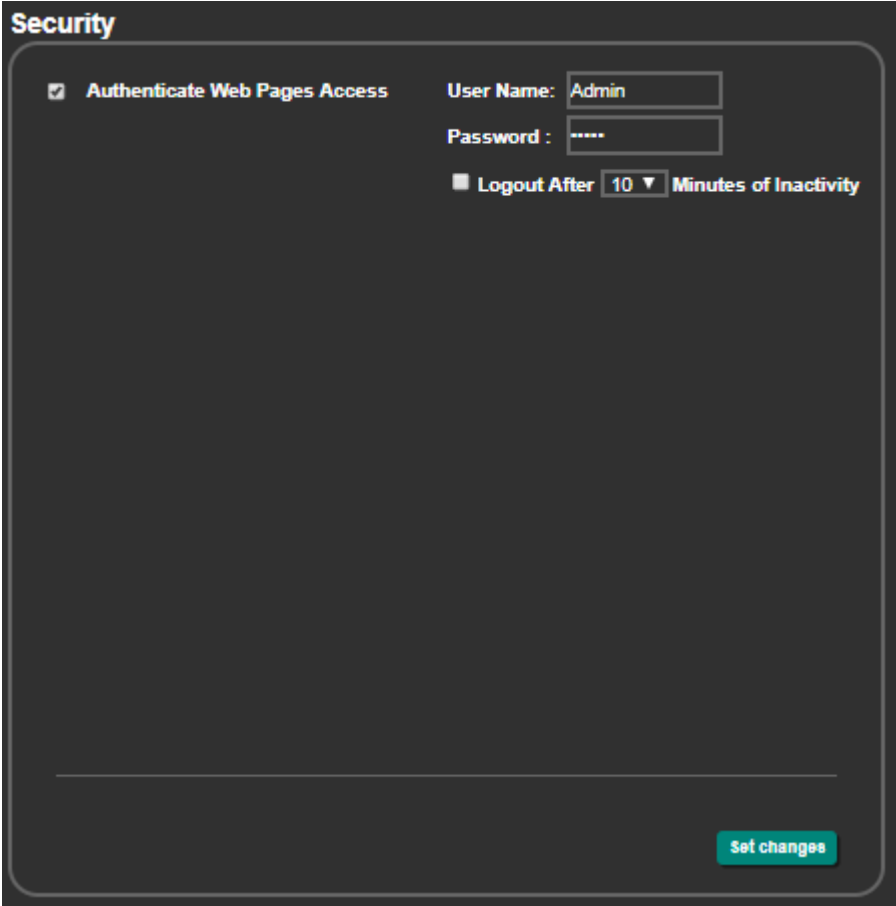

Figure 47: Security Page

2. Enter the new password.
3. Click **Set changes**.
The following message appears:

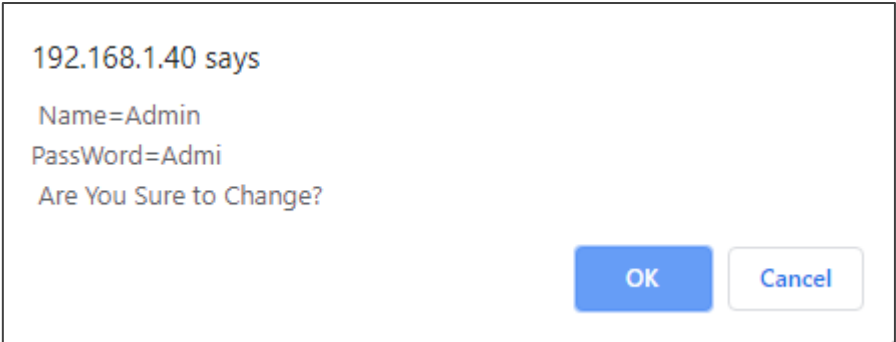

Figure 48: Security Page – Changing the Name/Password

4. Click **OK**.

The following message appears:

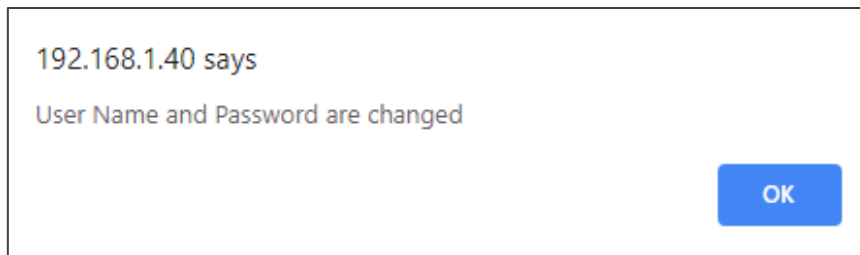

Figure 49: Security – Password Change Confirmation

5. Click **OK**.

Username and password have changed.

To disable security:

1. In the Navigation pane, click **Security**. The Security page appears.
2. Uncheck **Authenticate Web pages Access**.
Current credentials are grayed out.
3. Click **Set changes**
The following message appears:



Figure 50: Security – Security Disable Confirmation

4. Click **OK**.
Authentication is not required.

To enable security:

1. In the Navigation pane, click **Security**. The Security page appears.
2. Check **Authenticate Web pages Access**.
Previous credentials are restored.
3. Click **Set changes**
The following message appears:



Figure 51: Security – Security Enable Confirmation

4. Click **OK**.
 appears, and authentication is now required.

Viewing About Page

In the Navigation pane, click **About** to view the **TP-594Txr** Web page version and Kramer Electronics Ltd details.



Figure 52: About Page

Firmware Upgrade



The latest firmware version can be downloaded from the Kramer Web site at www.kramerav.com/downloads/TP-594Rxr or www.kramerav.com/downloads/TP-594Txr

You can upgrade the firmware on **TP-594Txr** and **TP-594Rxr** (separately) in any of the following methods:

- The device embedded web pages (see [Upgrading the Firmware](#) on page 31).
- Using the Kramer **K-UPLOAD** software to upgrade the firmware via the **TP-594Txr** / **TP-594Rxr** PROG USB port (15), via the CONTROL RS-232 port (12) or via the CONTROL Ethernet port (13).



The latest version of **K-UPLOAD** and installation instructions can be downloaded from our website at: www.kramerav.com/support/product_downloads.asp.

- Directly using a memory stick (see [Upgrading Firmware Using a Memory Stick](#) on page 45).

Upgrading Firmware Using a Memory Stick

You can upgrade **TP-594Txr** / **TP-594Rxr** via the USB port (15) on the rear panel.

To upgrade the firmware via the USB port:

1. Download the firmware `.Bin` file and copy it to the root folder of a USB flash drive memory stick, formatted with FAT32 system.
2. Connect your PC to the device.
3. Connect the USB flash drive to the device.
4. Send the `X-UPGRADE` command to the device (via RS-232 or Ethernet):
 - For **TP-594Txr**: `"#X-UPGRADE IN.USB_PORT.1,TP-594TXR_All*.Bin"`.
 - For **TP-594Rxr**: `"#X-UPGRADE IN.USB_PORT.1,TP-594RXR_All*.Bin"`.
5. Check that the firmware was updated in the lower left side of the device Navigation pane (see [Browsing Web Pages](#) on page 25).

Technical Specifications

TP-594Txr

Input	HDMI	On a female HDMI connector
Output	HDBT	On an RJ-45 connector
	Optical (Digital Audio)	On a TOSLINK® connector
Input/Output (configurable)	Balanced Stereo Audio	On a 5-pin terminal block connector

TP-594Rxr

Input	HDBT	On an RJ-45 connector
	Optical (Digital Audio)	On a TOSLINK® connector
Output	HDMI	On a female HDMI connector
Input/Output (configurable)	Balanced Stereo Audio	On a 5-pin terminal block connector

General

Ports	Ethernet	On an RJ-45 female connector for device control and LAN extension
	RS-232	On a 3-pin terminal block for serial link extension
	IR	On a 3.5mm mini jack for IR extension
	Control RS-232	On a 3-pin terminal block for device control
	USB	On a female USB-A connector for device firmware upgrade
Extension	We recommend that you use Kramer shielded cables to achieve optimum extension ranges	
	Compression	Low-latency compression for signals above 4K@60 (4:2:0)
	4K@60 (4:4:4) Range	Compression: up to 100m (330ft)
	4K@60 (4:2:0) Range	No compression: up to 100m (330ft)
	Full HD (1080p@60Hz) Range	No compression: up to 130m (430ft) Ultra-long mode: up to 180m (590ft)
	Compliance	HDBaseT 2.0
Video	Max Bandwidth	Compression: 17.95Gbps (5.98Gbps per graphic channel) No compression: 10.2Gbps (3.4Gbps per graphic channel)
	Max Resolution	Compression: 3840x2160@60Hz 4:4:4 24bpp No compression: 4096x2160@60Hz 4:2:0 24bpp
	Compliance	HDCP 2.2, HDR 10
Controls	Front Panel	IN (TP-594Txr only), GATEWAY Tx/Rx (only), POE STATUS, LINK and ON LED indicators
	Rear Panel	DIP-switches
Extended RS-232	Baud Rate	300 to 115200
Extended Ethernet	Data Rate	Up to 100Mbps
Extended IR	Frequency	0kHz to 60kHz
Power	Consumption	TP-594Txr + TP-594Rxr: 48V DC, 0.65A TP-594Txr: 48V DC, 0.45A TP-594Rxr: 12V DC, 1.1A
	Source	TP-594Txr: 48V DC, 1.36A TP-594Rxr: 12V DC, 2A
Environmental Conditions	Operating Temperature	0° to +40°C (32° to 104°F)
	Storage Temperature	-40° to +70°C (-40° to 158°F)
	Humidity	10% to 90%, RHL non-condensing

Regulatory Compliance	Safety	CE, UL
	Environmental	RoHs, WEEE
Enclosure	Size	Tool
	Type	Aluminum
	Cooling	Convection ventilation
General	Net Dimensions (W, D, H), each	18.7cm x 11.5cm x 2.5cm (7.4" x 4.5" x 1")
	Shipping Dimensions (W, D, H)	34.5cm x 16.5cm x 5.2 cm (13.6" x 6.5" x 2")
	Net Weight, each	0.4kg (0.9bs) approx.
	Shipping Weight	0.95kg (2.1lbs) approx.
Accessories	Included	1 power adapter, 1 power cord and 1 bracket set per device
Specifications are subject to change without notice at www.kramerav.com		

Default Communication Parameters

RS-232	
Baud Rate:	115,200
Data Bits:	8
Stop Bits:	1
Parity:	None
Command Format:	ASCII
Example (pass embedded audio to the output):	#AUD-EMB 1, 2, 0<CR>
Network	
IP Address:	DHCP enabled
Fallback IP Address:	TP-594Txr: 192.168.1.39; TP-594Rxr 192.168.1.40
Fallback subnet mask:	255.255.255.0
Fallback gateway:	192.168.1.1
TCP Port:	5000
UDP Port:	50000
Security Password:	User/Password: Admin/Admin
Factory Reset	
Via rear panel button:	Press the RESET button while plugging the power to reset the machine, hold for a few seconds and release.
Web page soft factory reset:	In Device Settings, click Soft Factory Reset (IP Addresses remain unchanged).
Web page hard factory reset:	TP-594Rxr only, in Control Gateway Serial, click Reset Ethernet Settings.
Protocol 3000	Use "#FACTORY" command and use "#RESET" to restore the factory default values.

Default EDID

Monitor

Model name..... VM-10H2
 Manufacturer..... KMR
 Plug and Play ID..... KMR1200
 Serial number..... n/a
 Manufacture date..... 2016, ISO week 14
 Filter driver..... None

EDID revision..... 1.3
 Input signal type..... Digital
 Color bit depth..... Undefined
 Display type..... Monochrome/grayscale
 Screen size..... 520 x 320 mm (24.0 in)
 Power management..... Standby, Suspend, Active off/sleep
 Extension blocs..... 1 (CEA-EXT)

DDC/CI..... Not supported

Color characteristics

Default color space..... Non-sRGB
 Display gamma..... 2.20
 Red chromaticity..... Rx 0.674 - Ry 0.319
 Green chromaticity..... Gx 0.188 - Gy 0.706
 Blue chromaticity..... Bx 0.148 - By 0.064
 White point (default).... Wx 0.313 - Wy 0.329
 Additional descriptors... None

Timing characteristics

Horizontal scan range.... 30-83kHz
 Vertical scan range..... 56-76Hz
 Video bandwidth..... 170MHz
 CVT standard..... Not supported
 GTF standard..... Not supported
 Additional descriptors... Established timings
 Preferred timing..... Yes
 Native/preferred timing.. 1920x1080p at 60Hz
 Modeline..... "1920x1080" 148.500 1920 2008 2052 2200 1080 1084 1089 1125 +hsync +vsync

Standard timings supported

640 x 480p at 60Hz - IBM VGA
 640 x 480p at 72Hz - VESA
 640 x 480p at 75Hz - VESA
 800 x 600p at 60Hz - VESA
 800 x 600p at 72Hz - VESA
 800 x 600p at 75Hz - VESA
 1024 x 768p at 60Hz - VESA
 1024 x 768p at 70Hz - VESA
 1024 x 768p at 75Hz - VESA
 1280 x 1024p at 75Hz - VESA
 1600 x 900p at 60Hz - VESA STD
 1280 x 800p at 60Hz - VESA STD
 1600 x 1200p at 60Hz - VESA STD
 1024 x 768p at 85Hz - VESA STD
 800 x 600p at 85Hz - VESA STD
 640 x 480p at 85Hz - VESA STD
 1152 x 864p at 75Hz - VESA STD
 1280 x 960p at 60Hz - VESA STD
 848 x 480p at 60Hz - VESA
 1280 x 768p at 60Hz - VESA
 1280 x 1024p at 60Hz - VESA
 1360 x 768p at 60Hz - VESA
 1440 x 900p at 60Hz - VESA
 1400 x 1050p at 60Hz - VESA
 1650 x 1050p at 60Hz - VESA

EIA/CEA-861 Information

Revision number..... 3
 IT underscan..... Supported
 Basic audio..... Supported
 YCbCr 4:4:4..... Not supported
 YCbCr 4:2:2..... Not supported
 Native formats..... 1
 Detailed timing #1..... 720x480i at 30Hz
 Modeline..... "720x480" 8.490 720 808 857 981 480 488 498 570 interlace +hsync +vsync
 Detailed timing #2..... 852x480p at 60Hz (16:9(
 Modeline..... "852x480" 49.450 852 1380 1429 1572 480 484 489 525 +hsync +vsync
 Detailed timing #3..... 1366x768p at 50Hz (16:9(
 Modeline..... "1366x768" 84.650 1366 1894 1943 2086 768 772 777 813 +hsync +vsync
 Detailed timing #4..... 1366x768p at 60Hz (16:9(
 Modeline..... "1366x768" 101.610 1366 1894 1943 2086 768 772 777 813 +hsync +vsync
 Detailed timing #5..... 720x576p at 50Hz (4:3(
 Modeline..... "720x576" 27.370 720 728 841 880 576 578 596 621 -hsync -vsync

CE video identifiers (VICs) - timing/formats supported

1920 x 1080p at 60Hz - HDTV (16:9, 1:1) [Native]
 1920 x 1080i at 60Hz - HDTV (16:9, 1:1(
 720 x 480p at 60Hz - EDTV (4:3, 8:9(
 1920 x 1080i at 50Hz - HDTV (16:9, 1:1(
 1920 x 1080p at 50Hz - HDTV (16:9, 1:1(
 1920 x 1080p at 24Hz - HDTV (16:9, 1:1(
 1920 x 1080p at 30Hz - HDTV (16:9, 1:1(
 1920 x 1080p at 30Hz - HDTV (16:9, 1:1(
 1920 x 1080p at 30Hz - HDTV (16:9, 1:1(
 1920 x 1080p at 30Hz - HDTV (16:9, 1:1(
 1920 x 1080p at 30Hz - HDTV (16:9, 1:1(
 1920 x 1080p at 30Hz - HDTV (16:9, 1:1(
 1920 x 1080p at 30Hz - HDTV (16:9, 1:1(
 1920 x 1080p at 30Hz - HDTV (16:9, 1:1(
 1920 x 1080p at 30Hz - HDTV (16:9, 1:1(
 1920 x 1080p at 30Hz - HDTV (16:9, 1:1(
 1920 x 1080p at 30Hz - HDTV (16:9, 1:1(
 1920 x 1080p at 30Hz - HDTV (16:9, 1:1(
 1920 x 1080p at 30Hz - HDTV (16:9, 1:1(
 1920 x 1080p at 30Hz - HDTV (16:9, 1:1(
 NB: NTSC refresh rate = (Hz*1000)/1001

CE audio data (formats supported)

LPCM 2-channel, 16/20/24 bit depths at 32/44/48 kHz

CE speaker allocation data

Channel configuration.... 2.0
 Front left/right..... Yes
 Front LFE..... No
 Front center..... No
 Rear left/right..... No
 Rear center..... No
 Front left/right center.. No
 Rear left/right center... No
 Rear LFE..... No

CE vendor specific data (VSDB)

IEEE registration number. 0x000C03
 CEC physical address..... 1.0.0.3

Maximum TMDS clock..... 165MHz

Report information

Date generated..... 19/02/2019
Software revision..... 2.70.0.989
Data source..... Real-time 0x0071
Operating system..... 6.1.7601.2.Service Pack 1

Raw data

,00 FF,FF,FF,FF,FF,FF,00,2D,B2,00,12,00,00,00,00,0E,1A,01,03,80,34,20,78,E2,B3,25,AC,51,30,B4,26,
10,50,54,2 D,CF,00,A9,C0,81,00,A9,40,61,59,45,59,31,59,71,4F,81,40,02,3A,80,18,71,38,2D,40,58,2C,
45,00,0 F,24,21,00,00,1E,00,00,00,FD,00,38,4C,1E,53,11,00,0A,20,20,20,20,20,00,00,00,FC,00,56,
4 D,2D,31,30,48,32,0A,20,20,20,20,00,00,00,F7,00,00,08,42,A2,20,00,00,00,00,00,00,00,01,AF,
,02,03,23 C1,50,90,05,02,14,1F,20,22,5D,5F,61,62,64,66,67,69,6B,23,09,07,07,83,01,00,00,65,03,0C,
,00,10,03,51,03 D0,05,21,F0,2D,00,58,31,45,00,0F,1A,21,00,00,9E,51,13,54,D0,32,E0,2D,10,10,31,45,
,80 BA,88,21,00,00,1E,11,21,56,D0,52,00,2D,30,10,31,45,80,BA,88,21,00,00,1E,B1,27,56,D0,52,00,2D,
30,10,31,45,80,BA,88,21,00,00,1E,B1,0A,D0,A0,20,40,2D,20,08,71,22,01,80,E0,21,00,00,00,00,F1,CF

Protocol 3000

Kramer devices can be operated using Kramer Protocol 3000 commands sent via serial or Ethernet ports.

Understanding Protocol 3000

Protocol 3000 commands are a sequence of ASCII letters, structured according to the following.

- **Command format:**

Prefix	Command Name	Constant (Space)	Parameter(s)	Suffix
#	Command	_	Parameter	<CR>

- **Feedback format:**

Prefix	Device ID	Constant	Command Name	Parameter(s)	Suffix
~	nn	@	Command	Parameter	<CR><LF>

- **Command parameters** – Multiple parameters must be separated by a comma (,). In addition, multiple parameters can be grouped as a single parameter using brackets ([and]).
- **Command chain separator character** – Multiple commands can be chained in the same string. Each command is delimited by a pipe character (|).
- **Parameters attributes** – Parameters may contain multiple attributes. Attributes are indicated with pointy brackets (<...>) and must be separated by a period (.).

The command framing varies according to how you interface with the VS-88UT. The following figure displays how the # command is framed using terminal communication software (such as Hercules):

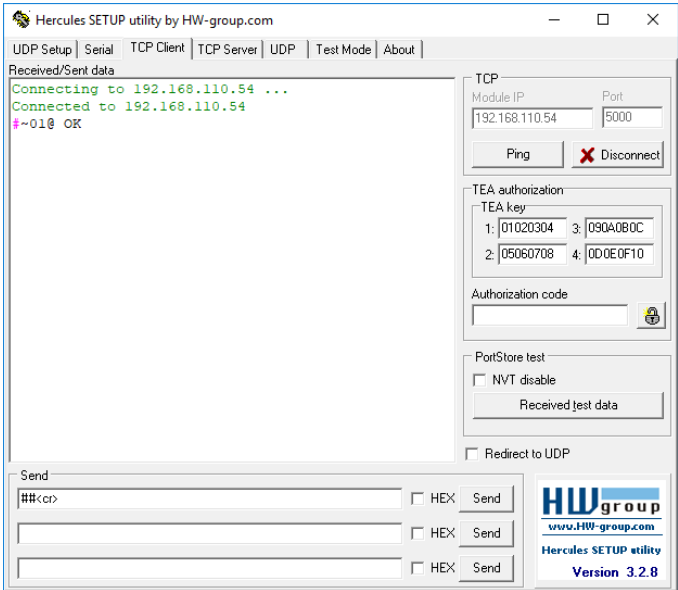

Protocol 3000 Commands



The commands in the following table apply to TP-594Txr and TP-594Rxr as defined for each command under the Function column.

Function	Description	Syntax	Parameters/Attributes	Example
# TP-594Txr TP-594Rxr	Protocol handshaking. Validates the Protocol 3000 connection and gets the machine number. Step-in master products use this command to identify the availability of a device.	COMMAND #<CR> FEEDBACK ~nn@_OK<CR><LF>		#<CR>
AUD-EMB	Set audio in video embedding status.	COMMAND #AUD-EMB_in,out,status<CR> FEEDBACK ~nn@AUD-EMB_in,out,status<CR><LF>	in – Audio input to be embedded number (1... max number of inputs) out – Video output to embed into number (1... max number of outputs) status – Embedding status 0 – Analog 1 – Embedded	Set audio in video embedding status for input 2 and output 1 to analog: #AUD-EMB_2,1,0<CR>
AUD-EMB? TP-594Txr	Get audio in video embedding status.	COMMAND #AUD-EMB?_in,out<CR> FEEDBACK ~nn@AUD-EMB_in,out,status<CR><LF>	in – Audio input: 1 out – Video output to embed into: 1 status – Embedding status 0 – Analog 1 – Embedded 2 – Auto	#AUD-EMB?_1,1<CR>
AUD-ONLY TP-594Txr	Enable/Disable audio only mode.	COMMAND #AUD-ONLY_channel,mode<CR> FEEDBACK ~nn@AUD-ONLY_channel,mode<CR><LF>	channel – Output number mode – Audio only mode 0 – Off 1 – On	Enable audio only mode: #AUD-ONLY_1,1<CR>
AUD-ONLY? TP-594Txr	Get audio only mode status.	COMMAND #AUD-ONLY?<CR> FEEDBACK ~nn@AUD-ONLY_channel,mode<CR><LF>	channel – Output number mode – Audio only mode 0 – Off 1 – On	Get audio only mode status: #AUD-ONLY?<CR>
AUD-SIGNAL? TP-594Txr	Get audio input signal status.	COMMAND #AUD-SIGNAL?_inp_id<CR> FEEDBACK ~nn@AUD-SIGNAL_inp_id,status<CR><LF>	inp_id – Input number 1 – Input 1 status – On/Off 0 – Off (no signal) 1 – On (signal present)	Get the status of input 1: #AUD-SIGNAL?_1<CR>
AV-SW-TIMEOUT TP-594Txr TP-594Rxr	Set auto switching timeout.	COMMAND #AV-SW-TIMEOUT_action,time_out<CR> FEEDBACK ~nn@AV-SW-TIMEOUT_action,time_out<CR><LF>	action – 4 – Disable 5V on video output if no input signal detected. time_out – Timeout in seconds 0 - 65535	Set the auto switching timeout to 5 seconds in the event of 5V disable when no input signal is detected: #AV-SW-TIMEOUT_4,5<CR>
AV-SW-TIMEOUT? TP-594Txr TP-594Rxr	Get auto switching timeout.	COMMAND #AV-SW-TIMEOUT?_action<CR> FEEDBACK ~nn@AV-SW-TIMEOUT_action,time_out<CR><LF>	action – 4 – Disable 5V on video output if no input signal detected time_out – Timeout in seconds	Get the Disable 5V on video output if no input signal detected timeout: #AV-SW-TIMEOUT?_4<CR>
BUILD-DATE? TP-594Txr TP-594Rxr	Get device build date.	COMMAND #BUILD-DATE?_<CR> FEEDBACK ~nn@BUILD-DATE_date,time<CR><LF>	date – Format: YYYY/MM/DD where YYYY = Year MM = Month DD = Day time – Format: hh:mm:ss where hh = hours mm = minutes ss = seconds	Get the device build date: #BUILD-DATE?<CR>
CEC-SND TP-594Rxr	Send CEC command to port.	COMMAND #CEC-SND_port_num,cmd_id,cmd_name,len,cec_command<CR> FEEDBACK ~nn@CEC-SND_port_num,cmd_id,cmd_name,status<CR><LF>	port_num – CEC port transmitting the command 1 – Port number cmd_id – serial number of command for flow control and response commands from device 0 to 255 cmd_name – command name len – 1-16 cec_command – CEC format command (in HEX format, no leading zeros, no '0x' prefix) status – 0 – Sent 1 – Gateway disabled 2 – Inactive CEC-Master 3 – Busy 4 – Illegal Message Parameter 5 – Illegal CEC Address Parameter 6 – Illegal CEC Command 7 – Timeout 8 – Error	Send CEC command to port: #CEC-SND_1,1,1,1,1<CR>

Function	Description	Syntax	Parameters/Attributes	Example
COM-ROUTE TP-594Rxr	Set tunneling port routing. ① This command sets tunneling port routing. Every com port can send or receive data from the ETH port. Set command can edit an existing configuration.	COMMAND #COM-ROUTE_ COM_Num,portType,ETHPort,ETH_rep_en,TCP_keep_alive_timing<CR> FEEDBACK ~nn@COM-ROUTE_ COM_Num,portType,ETHPort,ETH_rep_en,TCP_keep_alive_timing<CR><LF>	COM_Num – 1 portType – TCP/UDP 0 – TCP 1 – UDP ETHPort – TCP/UDP port number: 1 to 65535 ETH_rep_en – 0 – COM port does not send replies to new clients 1 – COM port sends replies to new clients. 0~1 (reply On/Off) TCP_keep_alive_timing – 1 to 3600 seconds - every x seconds the device sends an empty string to TCP client ("0")	Set tunneling for TCP port 5000; where the COM port sends replies to new clients and the keep alive time is 1: #COM-ROUTE_1,tcp,5000,1,1<CR>
COM-ROUTE? TP-594Rxr	Get tunneling port routing. ① This command sets tunneling port routing. Every com port can send or receive data from the ETH port. Set command can edit an existing configuration.	COMMAND #COM-ROUTE?_COM_Num<CR> FEEDBACK ~nn@COM-ROUTE_ COM_Num,portType,ETHPort,ETH_rep_en,TCP_keep_alive_timing<CR><LF>	COM_Num – 1 portType – TCP/UDP 0 – TCP 1 – UDP ETHPort – TCP/UDP port number ETH_rep_en – 0 – COM port does not send replies to new clients 1 – COM port sends replies to new clients. 0~1 (reply On/Off) TCP_keep_alive_timing – 1-3600 seconds - every x seconds the device sends an empty string to TCP client ("0")	Get tunneling port routing for all route tunnels: #COM-ROUTE?_*<CR>
COM-ROUTE-ADD TP-594Rxr	Add a communication route tunnel connection.	COMMAND #COM-ROUTE-ADD_ ComNum,PortType,EthPort,EthRepEn,Timeout<CR> FEEDBACK ~nn@COM-ROUTE-ADD_ ComNum,PortType,EthPort,EthRepEn,Timeout<CR><LF>	COM_Num – 1 portType – TCP/UDP 0 – TCP 1 – UDP ETHPort – TCP/UDP port number ETH_rep_en – 0 – COM port does not send replies to new clients 1 – COM port sends replies to new clients. 0~1 (reply On/Off) Timeout – Keep alive timeout in seconds (1 to 3600)	Add a communication route tunnel connection: #COM-ROUTE-ADD_1,1,1,1,1,1<CR>
COM-ROUTE-REMOVE TP-594Rxr	Remove a communication route tunnel connection.	COMMAND #COM-ROUTE-REMOVE_ ComNum<CR> FEEDBACK ~nn@COM-ROUTE-REMOVE_ ComNum<CR><LF>	Com_Num – 1	Remove a communication route tunnel connection: #COM-ROUTE-REMOVE_1<CR>
CPEDID TP-594Txr TP-594Rxr	Copy EDID data from the output to the input EEPROM. ① Destination bitmap size depends on device properties (for 64 inputs it is a 64-bit word). Example: bitmap 0x0013 means inputs 1,2 and 5 are loaded with the new EDID. In certain products Safe_mode is an optional parameter. See the HELP command for its availability.	COMMAND #CPEDID_ src_type,src_id,dst_type,dest_bitmap<CR> or #CPEDID_ src_type,src_id,dst_type,dest_bitmap,safe_mode<CR> FEEDBACK ~nn@CPEDID_ src_stg,src_id,dst_type,dest_bitmap<CR><LF> ~nn@CPEDID_ src_stg,src_id,st_type,dest_bitmap,safe_mode<CR><LF>	src_type – EDID source type (usually output) 0 – Input 1 – Output 2 – Default EDID src_id – Number of chosen source stage 1 – Output 1 dst_type – EDID destination type (usually input) 0 – Input dest_bitmap – Bitmap representing destination IDs. Format: XXXX...X, where X is hex digit. The binary form of every hex digit represents corresponding destinations. 0 – indicates that EDID data is not copied to this destination. 1 – indicates that EDID data is copied to this destination. safe_mode – 0 – device accepts the EDID as is without trying to adjust 1 – device tries to adjust the EDID (default value if no parameter is sent)	Copy the EDID data from the Output 1 (EDID source) to the Input: #CPEDID_1,1,0,0x01<CR> Copy the EDID data from the default EDID source to the Input: #CPEDID_2,0,0,0x01<CR>
DISPLAY? TP-594Txr TP-594Rxr	Get output HPD status.	COMMAND #DISPLAY?_out_id<CR> FEEDBACK ~nn@DISPLAY_ out_id,status<CR><LF>	out_id – Output number 1 – HDMI OUT status – HPD status according to signal validation 0 – Signal or sink is not valid 1 – Signal or sink is valid 2 – Sink and EDID is valid	Get the output HPD status of Output 1: #DISPLAY?_1<CR>
DPSW-STATUS? TP-594Txr TP-594Rxr	Get the DIP-switch state.	COMMAND #DPSW-STATUS?_dp_sw_id<CR> FEEDBACK ~nn@DPSW-STATUS_ dp_sw_id,status<CR><LF>	dp_sw_id – 1 to 4 (number of DIP switches) status – Up/down 0 – Up 1 – Down	get the DIP-switch 2 status: #DPSW-STATUS?_2<CR>

Function	Description	Syntax	Parameters/Attributes	Example
ETH-PORT TP-594Txr TP-594Rxr	Set Ethernet port protocol. ① If the port number you enter is already in use, an error is returned. The port number must be within the following range: 0-(2 ¹⁶ -1).	COMMAND #ETH-PORT_ portType,ETHPort<CR> FEEDBACK ~nn@ETH-PORT_ portType,ETHPort<CR><LF>	portType – TCP/UDP ETHPort – TCP/UDP port number (0 – 65535)	Set the Ethernet port protocol for TCP to port 12457: #ETH-PORT_0,12457<CR>
ETH-PORT? TP-594Txr TP-594Rxr	Get Ethernet port protocol.	COMMAND #ETH-PORT?_ portType<CR> FEEDBACK ~nn@ETH-PORT_ portType,ETHPort<CR><LF>	portType – TCP/UDP 0 – TCP 1 – UDP ETHPort – TCP / UDP port number (0 – 65535)	Get the Ethernet port protocol for UDP: #ETH-PORT?_1<CR>
ETH-TUNNEL? TP-594Rxr	Get an open tunnel parameters.	COMMAND #ETH-TUNNEL?_ TunnelId<CR> FEEDBACK ~nn@ETH-TUNNEL_ TunnelId,ComNum,PortType,EthPort,EthIp,RemotPort,EthRepEn,Wired<CR><LF>	TunnelId – Tunnel ID number, * (get all open tunnels) ComNum – UART number portType – TCP/UDP 0 – TCP 1 – UDP ETHPort – TCP/UDP port number EthIp – Client IP address RemotPort – Remote port number EthRepEn – 0 – COM port does not send replies to new clients 1 – COM port sends replies to new clients Wired – 0 – Not wired connection 1 – Wired connection	Set baud rate to 9600, 8 data bits, parity to none and stop bit to 1: #ETH-TUNNEL?_*<CR>
FACTORY TP-594Txr TP-594Rxr	Reset device to factory default configuration. ① This command deletes all user data from the device. The deletion can take some time. Your device may require powering off and powering on for the changes to take effect.	COMMAND #FACTORY<CR> FEEDBACK ~nn@FACTORY_OK<CR><LF>		Reset the device to factory default configuration: #FACTORY<CR>
GLOBAL-GW-ACTIVE TP-594Rxr	Set global activation state of the gateway device	COMMAND #GLOBAL-GW-ACTIVE_ state<CR> FEEDBACK ~nn@GLOBAL-GW-ACTIVE_ state<CR><LF>	state – Global gateway activation state: OFF – gateway is deactivated ON – gateway is activated	Set the global state of the gateway to active: #GLOBAL-GW-ACTIVE_ON<CR>
GLOBAL-GW-ACTIVE? TP-594Rxr	Get global gateway activation state	COMMAND #GLOBAL-GW-ACTIVE?<CR> FEEDBACK ~nn@GLOBAL-GW-ACTIVE_ state<CR><LF>	state – Global gateway activation state: OFF – gateway is deactivated ON – gateway is activated	Get global gateway activation state: #GLOBAL-GW-ACTIVE?<CR>
HDCP-MOD TP-594Txr TP-594Rxr	Set HDCP mode. ① Set HDCP working mode on the device input: HDCP supported - HDCP_ON [default]. HDCP not supported - HDCP OFF. HDCP support changes following detected sink - MIRROR OUTPUT. When you define 3 as the mode, the HDCP status is defined according to the connected output in the following priority: OUT 1, OUT 2. If the connected display on OUT 2 supports HDCP, but OUT 1 does not, then HDCP is defined as not supported. If OUT 1 is not connected, then HDCP is defined by OUT 2.	COMMAND #HDCP-MOD_ inp_id,mode<CR> FEEDBACK ~nn@HDCP-MOD_ inp_id,mode<CR><LF>	inp_id – Input number: 1 – HDMI IN mode – HDCP mode: 0 – HDCP Off 1 – HDCP On	Set the input HDCP-MODE of IN 1 to Off: #HDCP-MOD_1,0<CR>
HDCP-MOD? TP-594Txr TP-594Rxr	Get HDCP mode. ① Set HDCP working mode on the device input: HDCP supported - HDCP_ON [default]. HDCP not supported - HDCP OFF. HDCP support changes following detected sink - MIRROR OUTPUT.	COMMAND #HDCP-MOD?_ inp_id<CR> FEEDBACK ~nn@HDCP-MOD_ inp_id,mode<CR><LF>	inp_id – Input number: 1 – HDMI IN mode – HDCP mode: 0 – HDCP Off 1 – HDCP On	Get the input HDCP-MODE of IN 1 HDMI: #HDCP-MOD?_1<CR>





Function	Description	Syntax	Parameters/Attributes	Example
HDCP-STAT? TP-594Txr TP-594Rxr	Get HDCP signal status. ① Output stage (1) – get the HDCP signal status of the sink device connected to the specified output. Input stage (0) – get the HDCP signal status of the source device connected to the specified input.	COMMAND #HDCP-STAT?_stage,stage_id<CR> FEEDBACK ~nn@HDCP-STAT?_stage,stage_id,status<CR><LF>	stage – Input/Output 0 – Input 1 – Output stage_id – Number of chosen stage for the input stage 1 – HDMI IN For the output stage 1 – HDMI OUT status – Signal encryption status - valid values On/Off 0 – HDCP Off 1 – HDCP On	Get the output HDCP-STATUS of IN 1: #HDCP-STAT?_0,1<CR>
HELP TP-594Txr TP-594Rxr	Get command list or help for specific command.	COMMAND #HELP<CR> #HELP_command_name<CR> FEEDBACK 1. Multi-line: ~nn@Device_command,_command...<CR><LF> To get help for command use: HELP (COMMAND_NAME)<CR><LF> ~nn@HELP_command:<CR><LF> description<CR><LF> USAGE: usage<CR><LF>	command – Name of a specific command	Get the command list: #HELP<CR> To get help for AV-SW-TIMEOUT: HELP_AV-SW-TIMEOUT<CR>
INFO-IO? TP-594Txr TP-594Rxr	LEGACY COMMAND. Get in/out count.	COMMAND #INFO-IO?_<CR> FEEDBACK ~nn@INFO-IOnn_IN_inputs_count,OUT_outputs_count<CR><LF>	inputs_count – Number of inputs in the unit outputs_count – Number of outputs in the unit	Get inputs count: #INFO-IO?_<CR>
IR-SND TP-594Rxr	Send IR command to port.	COMMAND #IR-SND_PortNum,Cmdid,CmdName,Repeat,TotalPackages,PackageNum,<pronto command...><CR> FEEDBACK ~nn@IR-SND_PortNum,Cmdid,CmdName,Status<CR><LF>	Port_Num – IR port transmitting the command. *1 broadcasts to all ports 1 – port number Cmd_id – Serial number of command for flow control and response commands from device 0 to 255 CmdName – Command name (length limit 15 chars) Repeat_number – Of times the IR command is transmitted (limited to 50; repeats > 50 are truncated to 50), default = 1 Total_packages – Number of messages the original command was divided into, default = 1 Package_num – Chunk serial number 1 – Package number Pronto_command – Pronto format command (in HEX format, no leading zeros, no '0x' prefix) Status – IR Status 0 – Sent (no error) 1 – Stop 2 – Done 3 – Busy 4 – Wrong Parameter 5 – Nothing to Stop 6 – Start 7 – Timeout 8 – Error	Send IR command to port: #IR-SND_1,1,1,1,1,1,1,1<CR>
IR-STOP TP-594Rxr	Send IR stop command to port.	COMMAND #IR-STOP_PortNum,Cmdid,CmdName<CR> FEEDBACK ~nn@IR-STOP_PortNum,Cmdid,CmdName,Status<CR><LF>	Port_Num – [IR port transmitting the command. 1 – Port number Cmd_id – Serial number of command for flow control and response commands from device CommandName – String: IR command name limited to 15 chars. Controlling device must send the correct name (white space or commas forbidden) Status – IR Status 0 – Sent (no error) 1 – Stop 2 – Done 3 – Busy 4 – Wrong Parameter 5 – Nothing to Stop 6 – Start 7 – Timeout 8 – Error	Send IR stop command to IR Port 2: #IR-STOP_2,1,power<CR>

Function	Description	Syntax	Parameters/Attributes	Example												
LOAD TP-594Txr TP-594Rxr	Load file to device.	COMMAND #LOAD <i>file_name</i> , <i>size</i> <CR> FEEDBACK Data sending negotiation: * Device - ~01@LOAD <i>file_name</i> , <i>size</i> , READY <CR> <LF> * End User (+Device)- Send file in Protocol Packets * Device - ~01@LOAD <i>file_name</i> , <i>size</i> , OK <CR> <LF>	file_name – Name of file to save on device size – Size of file data that is sent Using the Packet Protocol Send a command: LDRV, LOAD, IROUT, LDEDID Receive Ready or ERR### If Ready: a. Send a packet, b. Receive OK on the last packet, c. Receive OK for the command Packet structure: Packet ID (1, 2, 3...) (2 bytes in length) Length (data length + 2 for CRC) – (2 bytes in length) Data (data length -2 bytes) CRC – 2 bytes <table border="1"> <thead> <tr> <th>01</th> <th>02</th> <th>03</th> <th>04</th> <th>05</th> <th></th> </tr> </thead> <tbody> <tr> <td>Packet ID</td> <td>Length</td> <td>Data</td> <td>CRC</td> <td></td> <td></td> </tr> </tbody> </table> 5. Response: ~NNNN_OK <CR> <LF> (Where NNNN is the received packet ID in ASCII hex digits.)	01	02	03	04	05		Packet ID	Length	Data	CRC			Load the file_response.dat file to the device: #LOAD <i>file_response.dat</i> , 5360 <CR>
01	02	03	04	05												
Packet ID	Length	Data	CRC													
LOCK-EDID? TP-594Txr TP-594Rxr	Get EDID lock state.	COMMAND #LOCK-EDID? <i>input_id</i> , <CR> FEEDBACK ~nn@LOCK-EDID <i>input_id</i> , <i>lock_mode</i> <CR> <LF>	input_id – 1 lock_mode – On/Off 0 – Off EDID unlocked 1 – On EDID locked	Get EDID lock state for HDMI IN: #LOCK-EDID? <i>1</i> <CR>												
LOGIN TP-594Txr TP-594Rxr	Set protocol permission. ⓘ For devices that support security, LOGIN allows the user to run commands with an End User or Administrator permission level. When the permission system is enabled, LOGIN enables running commands with the User or Administrator permission level. When set, login must be performed upon each connection. The permission system works only if security is enabled with the "SECUR" command. It is not mandatory to enable the permission system in order to use the device. In each device, some connections allow logging in to different levels. Some do not work with security at all. Connection may logout after timeout.	COMMAND #LOGIN <i>login_level</i> , <i>password</i> , <i>logout_timeout</i> <CR> FEEDBACK ~nn@LOGIN <i>login_level</i> , <i>password</i> , <i>logout_timeout</i> <i>OK</i> <CR> <LF> or ~nn@LOGIN <i>ERR</i> <i>004</i> <CR> <LF> (if bad password entered)	login_level – Level of permissions required (User or Admin) password – Predefined password (by PASS command). Default password is an empty string logout_timeout – Optional (disabled when undefined), inactivity auto-logout timeout, 0 to 60min in 5min steps, 10min is default, 0 is never.	Set the protocol permission level to Admin (when the password defined in the PASS command is 33333): #LOGIN <i>Admin</i> , 33333 <CR>												
LOGIN? TP-594Txr TP-594Rxr	Get current protocol permission level. ⓘ For devices that support security, LOGIN allows the user to run commands with an End User or Administrator permission level. In each device, some connections allow logging in to different levels. Some do not work with security at all. Connection may logout after timeout. The permission system works only if security is enabled with the "SECUR" command.	COMMAND #LOGIN? <i>OK</i> <CR> FEEDBACK ~nn@LOGIN <i>login_level</i> <CR> <LF>	login_level – Level of permissions required (User or Admin)	Get current protocol permission level: #LOGIN? <CR>												
LOGOUT TP-594Txr TP-594Rxr	Cancel current permission level. ⓘ Logs out from End User or Administrator permission levels to Not Secure.	COMMAND #LOGOUT <CR> FEEDBACK ~nn@LOGOUT <i>OK</i> <CR> <LF>		#LOGOUT <CR>												

Function	Description	Syntax	Parameters/Attributes	Example
MACH-NUM TP-594Txr TP-594Rxr	Set machine number. ① Some devices do not set the new machine number until the device is restarted. Some devices can change the machine number only from DIP-switches.	COMMAND #MACH-NUM_machine_number<CR> FEEDBACK ~nn@MACH-NUM_machine_number<CR><LF>	machine_number – New device machine number, 1 to 99	Set machine number: #MACH-NUM_1<CR>
MODEL? TP-594Txr TP-594Rxr	Get device model. ① This command identifies equipment connected to TP-594Txr and notifies of identity changes to the connected equipment. The Matrix saves this data in memory to answer REMOTE-INFO requests.	COMMAND #MODEL?_<CR> FEEDBACK ~nn@MODEL_model_name<CR><LF>	model_name – String of up to 19 printable ASCII chars	Get the device model: #MODEL?_<CR>
MUTE TP-594Txr TP-594Rxr	Set audio mute.	COMMAND #MUTE_channel,mute_mode<CR> FEEDBACK ~nn@MUTE_channel,mute_mode<CR><LF>	channel – 1 (Output number) mute_mode – On/Off 0 – Off 1 – On	Set speaker output to mute: #MUTE_1,1<CR>
MUTE? TP-594Txr TP-594Rxr	Get audio mute.	COMMAND #MUTE?_channel<CR> FEEDBACK ~nn@MUTE_channel,mute_mode<CR><LF>	channel – 1 (Output number) mute_mode – On/Off 0 – Off 1 – On	Get mute status of output 1 #MUTE_1?<CR>
NAME TP-594Txr TP-594Rxr	Set machine (DNS) name. ① The machine name is not the same as the model name. The machine name is used to identify a specific machine or a network in use (with DNS feature on).	COMMAND #NAME_machine_name<CR> FEEDBACK ~nn@NAME_machine_name<CR><LF>	machine_name – String of up to 15 alpha-numeric chars (can include hyphen, not at the beginning or end)	Set the DNS name of the device to room-442: #NAME_room-442<CR>
NAME? TP-594Txr TP-594Rxr	Get machine (DNS) name. ① The machine name is not the same as the model name. The machine name is used to identify a specific machine or a network in use (with DNS feature on).	COMMAND #NAME?_<CR> FEEDBACK ~nn@NAME_machine_name<CR><LF>	machine_name – String of up to 15 alpha-numeric chars (can include hyphen, not at the beginning or end)	Get the DNS name of the device: #NAME?_<CR>
NAME-RST TP-594Txr TP-594Rxr	Reset machine (DNS) name to factory default. ① Factory default of machine (DNS) name is "KRAMER_" + 4 last digits of device serial number.	COMMAND #NAME-RST<CR> FEEDBACK ~nn@NAME-RST_OK<CR><LF>		Reset the machine name (S/N last digits are 0102): #NAME-RST_KRAMER_0102<CR>
NET-DHCP TP-594Txr TP-594Rxr	Set DHCP mode. ① Only 1 is relevant for the mode value. To disable DHCP, the user must configure a static IP address for the device. Connecting Ethernet to devices with DHCP may take more time in some networks. To connect with a randomly assigned IP by DHCP, specify the device DNS name (if available) using the NAME command. You can also get an assigned IP by direct connection to USB or RS-232 protocol port, if available. For proper settings consult your network administrator. ① For Backward compatibility, the id parameter can be omitted. In this case, the Network ID, by default, is 0, which is the Ethernet control port.	COMMAND #NET-DHCP_id,mode<CR> FEEDBACK ~nn@NET-DHCP_id,mode<CR><LF>	id – Network ID—the device network interface (if there are more than one). Counting is 0 based, meaning the control port is '0', additional ports are 1,2,3.... mode – 0 – Static IP. 1 – DHCP.	Enable DHCP mode for port 1, if available: #NET-DHCP_1,1<CR>

Function	Description	Syntax	Parameters/Attributes	Example
NET-DHCP? TP-594Txr TP-594Rxr	Get DHCP mode. ① For Backward compatibility, the id parameter can be omitted. In this case, the Network ID, by default, is 0, which is the Ethernet control port.	COMMAND #NET-DHCP?_id<CR> FEEDBACK ~nn@NET-DHCP_id,mode<CR><LF>	id – Network ID—the device network interface (if there are more than one). Counting is 0 based, meaning the control port is '0', additional ports are 1,2,3.... mode – 0 – Do not use DHCP. Use the IP set by the factory or using the NET-IP or NET-CONFIG command. 1 – Try to use DHCP. If unavailable, use the IP set by the factory or using the NET-IP or NET-CONFIG command.	Get DHCP mode for port 1: #NET-DHCP?_1<CR>
NET-GATE TP-594Txr TP-594Rxr	Set gateway IP. ① A network gateway connects the device via another network and maybe over the Internet. Be careful of security issues. For proper settings consult your network administrator.	COMMAND #NET-GATE_ip_address<CR> FEEDBACK ~nn@NET-GATE_ip_address<CR><LF>	ip_address – Format: xxx.xxx.xxx.xxx	Set the gateway IP address to 192.168.0.1: #NET-GATE_192.168.000.001<CR>
NET-GATE? TP-594Txr TP-594Rxr	Get gateway IP. ① A network gateway connects the device via another network and maybe over the Internet. Be aware of security problems.	COMMAND #NET-GATE?_<CR> FEEDBACK ~nn@NET-GATE_ip_address<CR><LF>	ip_address – Format: xxx.xxx.xxx.xxx	Get the gateway IP address: #NET-GATE?_<CR>
NET-IP TP-594Txr TP-594Rxr	Set IP address. ① For proper settings consult your network administrator.	COMMAND #NET-IP_ip_address<CR> FEEDBACK ~nn@NET-IP_ip_address<CR><LF>	ip_address – Format: xxx.xxx.xxx.xxx	Set the IP address to 192.168.1.39: #NET-IP_192.168.001.039<CR>
NET-IP? TP-594Txr TP-594Rxr	Get IP address.	COMMAND #NET-IP?_<CR> FEEDBACK ~nn@NET-IP_ip_address<CR><LF>	ip_address – Format: xxx.xxx.xxx.xxx	Get the IP address: #NET-IP?_<CR>
NET-MAC? TP-594Txr TP-594Rxr	Get MAC address. ① For backward compatibility, the id parameter can be omitted. In this case, the Network ID, by default, is 0, which is the Ethernet control port.	COMMAND #NET-MAC?_id<CR> FEEDBACK ~nn@NET-MAC_id,mac_address<CR><LF>	id – Network ID—the device network interface (if there are more than one). Counting is 0 based, meaning the control port is '0', additional ports are 1,2,3.... mac_address – Unique MAC address. Format: XX-XX-XX-XX-XX-XX where X is hex digit	#NET-MAC?_id<CR>
NET-MASK TP-594Txr TP-594Rxr	Set subnet mask. ① For proper settings consult your network administrator.	COMMAND #NET-MASK_net_mask<CR> FEEDBACK ~nn@NET-MASK_net_mask<CR><LF>	net_mask – Format: xxx.xxx.xxx.xxx	Set the subnet mask to 255.255.0.0: #NET-MASK_255.255.000.000<CR>
NET-MASK? TP-594Txr TP-594Rxr	Get subnet mask.	COMMAND #NET-MASK?_<CR> FEEDBACK ~nn@NET-MASK_net_mask<CR><LF>	net_mask – Format: xxx.xxx.xxx.xxx	Get the subnet mask: #NET-MASK?_<CR>
PASS TP-594Txr TP-594Rxr	Set password for login level. ① The default password is an empty string.	COMMAND #PASS_login_level,password<CR> FEEDBACK ~nn@PASS_login_level,password<CR><LF>	login_level – Level of login to set (End User or Administrator). password – Password for the login_level. Up to 15 printable ASCII chars	Set the password for the Admin protocol permission level to 33333: #PASS_Admin,33333<CR>
PASS? TP-594Txr TP-594Rxr	Get password for login level. ① The default password is an empty string.	COMMAND #PASS?_login_level<CR> FEEDBACK ~nn@PASS_login_level,password<CR><LF>	login_level – Level of login to set (End User or Administrator). password – Password for the login_level. Up to 15 printable ASCII chars	Get the password for the Admin protocol permission level: #PASS?_Admin<CR>
PROT-VER? TP-594Txr TP-594Rxr	Get device protocol version.	COMMAND #PROT-VER?_<CR> FEEDBACK ~nn@PROT-VER_3000:version<CR><LF>	version – XX.XX where X is a decimal digit	Get the device protocol version: #PROT-VER?_<CR>
RESET TP-594Txr TP-594Rxr	Reset device. ① To avoid locking the port due to a USB bug in Windows, disconnect USB connections immediately after running this command. If the port was locked, disconnect and reconnect the cable to reopen the port.	COMMAND #RESET<CR> FEEDBACK ~nn@RESET_OK<CR><LF>		Reset the device: #RESET<CR>
SECUR TP-594Txr TP-594Rxr	Start/stop security. ① The permission system works only if security is enabled with the "SECUR" command.	COMMAND #SECUR_security_mode<CR> FEEDBACK ~nn@SECUR_security_mode<CR><LF>	security_mode – 0 – OFF (disables security) 1 – ON (enables security)	Enable the permission system: #SECUR_0<CR>
SECUR? TP-594Txr TP-594Rxr	Get current security state. ① The permission system works only if security is enabled with the "SECUR" command.	COMMAND #SECUR?_<CR> FEEDBACK ~nn@SECUR_security_mode<CR><LF>	security_mode – 0 – OFF (disables security) 1 – ON (enables security)	Get current security state: #SECUR?_<CR>

Function	Description	Syntax	Parameters/Attributes	Example
SIGNAL? TP-594Txr TP-594Rxr	Get input signal status.	COMMAND #SIGNAL?_inp_id<CR> FEEDBACK ~nn@SIGNAL_ inp_id, status<CR><LF>	inp_id – Input number 1 – HDMI IN status – Signal status according to signal validation: 0 – Off 1 – On	Get the input signal lock status of IN 1: #SIGNAL?_1<CR>
SN? TP-594Txr TP-594Rxr	Get device serial number.	COMMAND #SN?_<CR> FEEDBACK ~nn@SN_ serial_number<CR><LF>	serial_number – 14 decimal digits, factory assigned	Get the device serial number: #SN?_<CR>
UART TP-594Rxr	Set com port configuration. The command is backward compatible, meaning that if the extra parameters do not exist, FW goes to. RS-232. Stop_bits 1.5 is only relevant for 5 data_bits.	COMMAND #UART_ COM_Num, baud_rate, data_bits, parity, stop_bits <CR> FEEDBACK ~nn@UART_ COM_Num, baud_rate, data_bits, parity, stop_bits <CR><LF>	COM_Num – 1 baud_rate – 4800, 9600, 19200, 38400, 57600, 115200 data_bits – 5-8 parity – Parity Type N – No O – Odd E – Even M – Mark S – Space stop_bits – 1/1.5/2	Set baud rate to 9600, 8 data bits, parity to none and stop bit to 1: #UART_9600,8,N,1<CR>
UART? TP-594Rxr	Get com port configuration. The command is backward compatible, meaning that if the extra parameters do not exist, FW goes to. RS-232. Stop_bits 1.5 is only relevant for 5 data_bits.	COMMAND #UART?_COM_Num<CR> FEEDBACK ~nn@UART_ COM_Num, baud_rate, data_bits, parity, stop_bits <CR><LF>	COM_Num – 1 baud_rate – 4800, 9600, 19200, 38400, 57600, 115200 data_bits – 5-8 parity – Parity Type N – No O – Odd E – Even M – Mark S – Space stop_bits – 1/1.5/2	Set baud rate to 9600, 8 data bits, parity to none and stop bit to 1: #UART?_1,9600,8,N,1<CR>
VERSION? TP-594Txr TP-594Rxr	Get firmware version number.	COMMAND #VERSION?_<CR> FEEDBACK ~nn@VERSION_ firmware_version<CR><LF>	firmware_version – XX.XX.XXXX where the digit groups are: major.minor.build version	Get the device firmware version number: #VERSION?_<CR>
VID-COMPRESSION TP-594Txr	Set compression attributes.	COMMAND #VID-COMPRESSION_ stage, stage_id, algorithm, level<CR> FEEDBACK ~nn@VID-COMPRESSION_ stage, stage_id, algorithm, level<CR><LF>	stage – # output: 1 – output stage_id – # of chosen stage: 1 – Output on the device algorithm – 0 – None 1 – DSC level – Compression level: 1 – L1 (Normal)	Set the compression level for output 1 to DSC: #VID-COMPRESSION_1,1,1,1<CR>
VID-COMPRESSION? TP-594Txr	Get compression attributes.	COMMAND #VID-COMPRESSION?_ stage, stage_id<CR> FEEDBACK ~nn@VID-COMPRESSION_ stage, stage_id, algorithm, level<CR><LF>	stage – # output: 1 – output stage_id – # of chosen stage: 1 – Output on the device algorithm – 0 – None 1 – DSC level – Compression level: 1 – L1 (Normal)	Get the compression level for output 2: #VID-COMPRESSION?_1,2<CR>
VMUTE TP-594Txr TP-594Rxr	Set enable/disable video on output. ① Video mute parameter 2 (blank picture) is not supported.	COMMAND #VMUTE_ output_id, flag<CR> FEEDBACK ~nn@VMUTE_ output_id, flag<CR><LF>	output_id – System output 1 – HDMI OUT flag – Video Mute 0 – Video enabled 1 – Video disabled 2 – Blank picture	Disable the video output on HDMI OUT: #VMUTE_1,0<CR>
VMUTE? TP-594Txr TP-594Rxr	Get video on output status. ① Video mute parameter 2 (blank picture) is not supported.	COMMAND #VMUTE?_ output_id <CR> FEEDBACK ~nn@VMUTE_ output_id, flag<CR><LF>	output_id – System output 1 – HDMI OUT flag – Video Mute 0 – Video enabled 1 – Video disabled 2 – Blank picture	Get video output status: #VMUTE?_1<CR>
X-AUD-DETECT-LVL TP-594Txr	Set audio signal detection threshold level.	COMMAND #X-AUD-DETECT-LVL_?_<direction_type>.<port_type>.<port_index>.<signal_type>.<index>, signal_level<CR> FEEDBACK ~nn@X-AUD-DETECT-LVL_?_<direction_type>.<port_type>.<port_index>.<signal_type>.<index>, signal_level<CR><LF>	The following attributes comprise the signal ID: ▪ <direction_type> – ○ IN ○ HDMI ○ ANALOG_AUDIO ▪ <port_index> – 1 ▪ <signal_type> – ○ AUDIO ▪ <index> – 1 Signal_level – signal level, measured in Db: -90db to +20dB	Set the audio signal detection threshold level for the HDMI input to -47: #X-AUD-DETECT-LVL_ [IN.AN ALOG_AUDIO.1.AUDIO.1,IN .HDMI.1.AUDIO.1] , -47<CR>

Function	Description	Syntax	Parameters/Attributes	Example
X-AUD-DETECT-LVL? TP-594Txr	Get audio signal detection threshold level.	COMMAND #X-AUD-DETECT-LVL?_<direction_type>.<port_type>.<port_index>.<signal_type>.<index><CR> FEEDBACK ~nn@X-AUD-DETECT-LVL?_<direction_type>.<port_type>.<port_index>.<signal_type>.<index>,signal_level<CR><LF>	The following attributes comprise the signal ID: ▪ <direction_type> – ○ IN ▪ <port_type> – ○ HDMI ○ ANALOG_AUDIO ▪ <port_index> – 1 ▪ <signal_type> – ○ AUDIO ▪ <index> – 1 Signal_level – signal level, measured in Db: -90db to +20dB	Get the audio signal detection threshold level for HDMI input 1: #X-AUD-DETECT-LVL?_[IN.ANALOG_AUDIO.1.AUDIO.1,IN.HDMI.1.AUDIO.1]<CR> Get the audio signal detection threshold level for audio inputs: #X-AUD-DETECT-LVL?_* .AUDIO.*<CR>
X-FOLLOWERS-SW-MODE? TP-594Txr	Set auto-switch mode for a layer of followers for a given input signal.  This is an Extended Protocol 3000 command.	COMMAND #X-FOLLOWERS-SW-MODE_<direction_type>.<port_type>.<port_index>.<signal_type>.<index>,layer,strategy<CR> FEEDBACK Get: ~nn@X-FOLLOWERS-SW-MODE_<direction_type>.<port_type>.<port_index>.<signal_type>.<index>,layer,strategy<CR><LF>	The following attributes comprise the Input_signal_id: ▪ <direction_type> – ○ IN ▪ <port_type> – ○ HDMI ▪ <port_index> – 1 ▪ <signal_type> – ○ VIDEO ▪ <index> – 1 layer – AUDIO strategy – Manual/priority 0 – manual 1 – priority	Get audio embedding selection mode to priority: #X-FOLLOWERS-SW-MODE_IN.HDMI.1.VIDEO.1,AUDIO,1<CR>
X-FOLLOWERS-SW-MODE? TP-594Txr	Get auto-switch mode for a layer of followers for a given input signal.  This is an Extended Protocol 3000 command.	COMMAND #X-FOLLOWERS-SW-MODE?_<direction_type>.<port_type>.<port_index>.<signal_type>.<index>,layer<CR> FEEDBACK Get: ~nn@X-FOLLOWERS-SW-MODE_<direction_type>.<port_type>.<port_index>.<signal_type>.<index>,layer,strategy<CR><LF>	The following attributes comprise the Input_signal_id: ▪ <direction_type> – ○ IN ▪ <port_type> – ○ HDMI ▪ <port_index> – 1 ▪ <signal_type> – ○ VIDEO ▪ <index> – 1 layer – AUDIO strategy – Manual/priority 0 – manual 1 – priority	Get audio embedding selection mode to priority: #X-FOLLOWERS-SW-MODE?_IN.HDMI.1.VIDEO.1,AUDIO<CR>
X-GW-PORT-ACTIVE? TP-594Rxr	Set the gateway activation state per port.  This is an Extended Protocol 3000 command.	COMMAND #X-GW-PORT-ACTIVE_<port_id>,state<CR> FEEDBACK ~nn@X-GW-PORT-ACTIVE_<port_id>,state<CR><LF>	port_id – Identifies the port and signal type and includes the following attributes: ▪ <direction_type> – ○ OUT ○ BOTH ▪ <port_type> – ○ HDMI ○ RS-232 ○ IR ▪ <port_index> – 1 ▪ <signal_type> – ○ RS232 ○ IR ○ CEC ▪ <index> – 1 state – Global gateway activation state: OFF – disabled ON – enabled	Activate RS-232 on the gateway: #X-GW-PORT-ACTIVE_<BOTH>.RS232.1.RS232.1,ON<CR>
X-GW-PORT-ACTIVE? TP-594Rxr	Get the gateway activation state per port.  This is an Extended Protocol 3000 command.	COMMAND #X-GW-PORT-ACTIVE?_<port_id><CR> FEEDBACK ~nn@X-GW-PORT-ACTIVE_<port_id>,state<CR><LF>	port_id – Identifies the port and signal type and includes the following attributes: ▪ <direction_type> – ○ OUT ○ BOTH ▪ <port_type> – ○ HDMI ○ RS-232 ○ IR ○ CEC ▪ <port_index> – 1 ▪ <signal_type> – ○ RS232 ○ IR ○ CEC ▪ <index> – 1 state – Global gateway activation state: OFF – disabled ON – enabled	Get the gateway activation state for IR: #X-GW-PORT-ACTIVE?_<OUT>.IR.1.IR.1<CR>

Function	Description	Syntax	Parameters/Attributes	Example
X-ROUTE TP-594Txr TP-594Rxr	<p>Send routing command to matrix.</p> <p>It is recommended to use the command #SIGNALS-LIST to get the list of all signal IDs available in the system and which can be used in this command.</p> <p>Video 1 is the default port in this command and is implied even if not written:</p> <p>#X-ROUTE_OUT.SDI.5,IN.SDI.1<CR></p> <p>is interpreted as:</p> <p>#X-ROUTE_OUT.SDI.5.VIDEO.1,IN.SDI.1.VIDEO.1<CR></p> <p>This is an Extended Protocol 3000 command.</p>	<p>COMMAND</p> <p>#X-ROUTE_<direction_type>.<port_type>.<port_index1>.<signal_type1>.<index1>,<direction_type2>.<port_type2>.<port_index2>.<signal_type2>.<index2><CR></p> <p>FEEDBACK</p> <p>~nn@X-ROUTE_<direction_type>.<port_type>.<port_index1>.<signal_type1>.<index1>,<direction_type2>.<port_type2>.<port_index2>.<signal_type2>.<index2><CR><LF></p>	<p>The following attributes comprise the output signal ID (suffix 1) and input signal ID:</p> <ul style="list-style-type: none"> ▪ <direction_type> – <ul style="list-style-type: none"> ○ IN ○ OUT ▪ <port_type> – <ul style="list-style-type: none"> ○ HDMI ○ HDBT ○ ANALOG_AUDIO ○ TOS ○ SPDIF ▪ <port_index> – 1 ▪ <signal_type> – <ul style="list-style-type: none"> ○ AUDIO ○ ARC ○ CEC ▪ <index> – Indicates a specific channel number when there are multiple channels of the same type 	<p>TP-594Txr: Route ARC audio signal from HDBT to HDMI IN:</p> <p>#X-ROUTE_IN.HDMI.1.ARC.1,OUT.HDBT.1.ARC.1<CR></p> <p>TP-594Rxr: Route an ARC audio signal to HDBT from the analog audio:</p> <p>#X-ROUTE_IN.HDBT.1.ARC.1,IN.ANALOG_AUDIO.1.AUDIO.1<CR></p>
X-ROUTE? TP-594Txr TP-594Rxr	<p>Get routing status.</p> <p>It is recommended to use the command #SIGNALS-LIST to get the list of all signal IDs available in the system and which can be used in this command.</p> <p>VIDEO.1 are the default <signal_type> and <index> in this command and are implied even if not written:</p> <p>#X-ROUTE_OUT.SDI.5,IN.SDI.1<CR></p> <p>is interpreted as:</p> <p>#X-ROUTE_OUT.SDI.5.VIDEO.1,IN.SDI.1.VIDEO.1<CR></p> <p>This is an Extended Protocol 3000 command.</p>	<p>COMMAND</p> <p>#X-ROUTE?_<direction_type>.<port_type>.<port_index1>.<signal_type1>.<index1><CR></p> <p>FEEDBACK</p> <p>~nn@X-ROUTE?_<direction_type>.<port_type>.<port_index1>.<signal_type1>.<index1>,<direction_type2>.<port_type2>.<port_index2>.<signal_type2>.<index2><CR><LF></p>	<p>The following attributes comprise the output signal ID (1) and input signal ID (1):</p> <ul style="list-style-type: none"> ▪ <direction_type> – <ul style="list-style-type: none"> ○ IN ○ OUT ▪ <port_type> – <ul style="list-style-type: none"> ○ HDMI ○ HDBT ○ ANALOG_AUDIO ○ TOS ○ SPDIF ▪ <port_index> – 1 ▪ <signal_type> – <ul style="list-style-type: none"> ○ AUDIO ○ ARC ○ CEC ▪ <index> – Indicates a specific channel number when there are multiple channels of the same type 	<p>TP-594Txr : Get the audio output source:</p> <p>#X-ROUTE?_OUT.TOS.1.AUDIO.1<CR></p> <p>TP-594Rxr: Get the ARC output source:</p> <p>#X-ROUTE?_IN.HDBT.1.ARC.1<CR></p>
X-SET-FOLLOWERS TP-594Txr	<p>Set followers list for a given input signal.</p> <p>This syntax uses the new convention of using brackets to define a list of fields "[]".</p> <p>This is an Extended Protocol 3000 command.</p>	<p>COMMAND</p> <p>#X-SET-FOLLOWERS_<direction_type>.<port_type>.<port_index1>.<signal_type1>.<index1>,[<direction_type2>.<port_type2>.<port_index2>.<signal_type2>.<index2>,...]<CR></p> <p>FEEDBACK</p> <p>~nn@X-SET-FOLLOWERS_<direction_type>.<port_type>.<port_index1>.<signal_type1>.<index1>,[<direction_type2>.<port_type2>.<port_index2>.<signal_type2>.<index2>,...]<CR><LF></p>	<p>The following attributes comprise the primary signal ID (suffix 1) and follower signal ID (suffix 1):</p> <ul style="list-style-type: none"> ▪ <direction_type> – <ul style="list-style-type: none"> ○ IN ▪ <port_type> – <ul style="list-style-type: none"> ○ HDMI ○ ANALOG_AUDIO ▪ <port_index> – 1 ▪ <signal_type> – <ul style="list-style-type: none"> ○ VIDEO ○ AUDIO ▪ <index> – 1 	<p>Set HDMI audio signal to follow HDMI IN:</p> <p>#X-SET-FOLLOWERS_IN.HDMI.1.VIDEO.1,[IN.HDMI.1.AUDIO.1,IN.ANALOG_AUDIO.1.AUDIO.1]<CR></p> <p>Set analog audio signal to follow HDMI IN:</p> <p>#X-SET-FOLLOWERS_IN.HDMI.1.VIDEO.1,[IN.ANALOG_AUDIO.1.AUDIO.1,IN.HDMI.1.AUDIO.1]<CR></p>
X-SET-FOLLOWERS? TP-594Txr	<p>Get followers list of a given input signal.</p> <p>This syntax uses the new convention of using brackets to define a list of fields "[]".</p> <p>This is an Extended Protocol 3000 command.</p>	<p>COMMAND</p> <p>#X-SET-FOLLOWERS?_<direction_type>.<port_type>.<port_index1>.<signal_type1>.<index1><CR></p> <p>FEEDBACK</p> <p>~nn@X-SET-FOLLOWERS?_<direction_type>.<port_type>.<port_index1>.<signal_type1>.<index1>,[<direction_type2>.<port_type2>.<port_index2>.<signal_type2>.<index2>,...]<CR><LF></p>	<p>The following attributes comprise the primary signal ID (suffix 1) and follower signal ID (suffix 1):</p> <ul style="list-style-type: none"> ▪ <direction_type> – <ul style="list-style-type: none"> ○ IN ▪ <port_type> – <ul style="list-style-type: none"> ○ HDMI ○ ANALOG_AUDIO ▪ <port_index> – 1 ▪ <signal_type> – <ul style="list-style-type: none"> ○ VIDEO ○ AUDIO ▪ <index> – 1 	<p>Get the audio followers list of HDMI 1 input signal:</p> <p>#X-SET-FOLLOWERS?_IN.HDMI.1.VIDEO.1<CR></p>

Function	Description	Syntax	Parameters/Attributes	Example
X-CEC-MEMBERS? TP-594Rxx	Get CEC members list of a given output signal. ① This syntax uses the new convention of using brackets to define a list of fields "[]". This is an Extended Protocol 3000 command.	COMMAND #X-CEC-MEMBERS?<direction_type>.<port_type>.<port_index>.<signal_type>.<index><CR> FEEDBACK ~nn@X-CEC-MEMBERS.<direction_type>.<port_type>.<port_index>.<signal_type>.<index>,<logical_id1>,<logical_id2>,. . .]<CR><LF>	The following attributes comprise the primary signal ID (suffix 1) and CEC members list (logical ID list): ▪<direction_type> – IN ▪<port_type> – ○ HDMI ▪<port_index> – The port number as printed on the front or rear panel ▪<signal_type> – ○ VIDEO ▪<index> – Indicates a specific channel number when there are multiple channels of the same type ▪Logical_id – CEC logical ID value (0-15)	Get the CEC members list of HDMI 1 input signal: #X-CEC-MEMBERS?IN.HDMI.1.VIDEO.1<CR>
X-CEC-GW-MEMBER TP-594Rxx	Set CEC gateway member ID for a given output signal. Note: Member ID 0 is reserved for "TV" only. ① This syntax uses the new convention of using brackets to define a list of fields "[]". This is an Extended Protocol 3000 command.	COMMAND #X-CEC-GW-MEMBER.<direction_type>.<port_type>.<port_index>.<signal_type>.<index><CR> FEEDBACK ~nn@X-CEC-GW-MEMBER.<direction_type>.<port_type>.<port_index>.<signal_type>.<index>,<logical_id><CR><LF>	The following attributes comprise the primary signal ID (suffix 1) and CEC gateway member ID (logical ID): □<direction_type> – OUT □<port_type> – ○ HDMI □<port_index> – The port number as printed on the front or rear panel □<signal_type> – ○ VIDEO □<index> – Indicates a specific channel number when there are multiple channels of the same type □Logical_id – CEC logical ID value (1-15)	Set the CEC gateway member ID 14 of HDMI 1 input signal: #X-CEC-GW-MEMBEROUT.HDMI.1.VIDEO.1,14<CR>
X-CEC-GW-MEMBER? TP-594Rxx	Get CEC gateway member ID for a given output signal. This syntax uses the new convention of using brackets to define a list of fields "[]". This is an Extended Protocol 3000 command.	COMMAND #X-CEC-GW-MEMBER?<direction_type>.<port_type>.<port_index>.<signal_type>.<index><CR> FEEDBACK ~nn@X-CEC-GW-MEMBER.<direction_type>.<port_type>.<port_index>.<signal_type>.<index>,<logical_id><CR><LF>	The following attributes comprise the primary signal ID (suffix 1) and CEC gateway member ID (logical ID): ▪<direction_type> – OUT ▪<port_type> – ○ HDMI ▪<port_index> – The port number as printed on the front or rear panel ▪<signal_type> – ○ VIDEO ▪<index> – Indicates a specific channel number when there are multiple channels of the same type ▪Logical_id – CEC logical ID value (1-15)	Get the CEC gateway member of HDMI 1 input signal: #X-CEC-GW-MEMBEROUT.HDMI.1.VIDEO.1,14<CR>
X-UPGRADE TP-594Txx TP-594Rxx	Use to upgrade the firmware (see Firmware Upgrade on page 45). ① This syntax uses the new convention of using brackets to define a list of fields "[]". This is an Extended Protocol 3000 command.	COMMAND #X-UPGRADE.<direction_type>.<port_type>.<port_index>,<file_name><CR>	The following attributes comprise the primary signal ID (suffix 1) and CEC gateway member ID (logical ID): □<direction_type> – IN □<port_type> – ○ USB_PORT □<port_index> – 1 □<file_name> – CEC logical ID value (1-15)	Perform FW upgrade for TP-594Txx: #X-UPGRADEIN.USB_PORT.1,TP-594TXR_All*.Bin<CR> Perform FW upgrade for TP-594Rxx: #X-UPGRADEIN.USB_PORT.1,TP-594RXX_All*.Bin<CR>

Result and Error Codes

Syntax

In case of an error, the device responds with an error message. The error message syntax:

- **~NN@ERR XXX<CR><LF>** – when general error, no specific command
- **~NN@CMD ERR XXX<CR><LF>** – for specific command
- **NN** – machine number of device, default = 01
- **XXX** – error code

Error Codes

Error Name	Error Code	Description
P3K_NO_ERROR	0	No error
ERR_PROTOCOL_SYNTAX	1	Protocol syntax
ERR_COMMAND_NOT_AVAILABLE	2	Command not available
ERR_PARAMETER_OUT_OF_RANGE	3	Parameter out of range
ERR_UNAUTHORIZED_ACCESS	4	Unauthorized access
ERR_INTERNAL_FW_ERROR	5	Internal FW error
ERR_BUSY	6	Protocol busy
ERR_WRONG_CRC	7	Wrong CRC
ERR_TIMEOUT	8	Timeout
ERR_RESERVED	9	(Reserved)
ERR_FW_NOT_ENOUGH_SPACE	10	Not enough space for data (firmware, FPGA...)
ERR_FS_NOT_ENOUGH_SPACE	11	Not enough space – file system
ERR_FS_FILE_NOT_EXISTS	12	File does not exist
ERR_FS_FILE_CANT_CREATED	13	File can't be created
ERR_FS_FILE_CANT_OPEN	14	File can't open
ERR_FEATURE_NOT_SUPPORTED	15	Feature is not supported
ERR_RESERVED_2	16	(Reserved)
ERR_RESERVED_3	17	(Reserved)
ERR_RESERVED_4	18	(Reserved)
ERR_RESERVED_5	19	(Reserved)
ERR_RESERVED_6	20	(Reserved)
ERR_PACKET_CRC	21	Packet CRC error
ERR_PACKET_MISSED	22	Packet number isn't expected (missing packet)
ERR_PACKET_SIZE	23	Packet size is wrong
ERR_RESERVED_7	24	(Reserved)
ERR_RESERVED_8	25	(Reserved)
ERR_RESERVED_9	26	(Reserved)
ERR_RESERVED_10	27	(Reserved)
ERR_RESERVED_11	28	(Reserved)
ERR_RESERVED_12	29	(Reserved)
ERR_EDID_CORRUPTED	30	EDID corrupted
ERR_NON_LISTED	31	Device specific errors
ERR_SAME_CRC	32	File has the same CRC – no changed
ERR_WRONG_MODE	33	Wrong operation mode
ERR_NOT_CONFIGURED	34	Device/chip was not initialized

The warranty obligations of Kramer Electronics Inc. ("Kramer Electronics") for this product are limited to the terms set forth below:

What is Covered

This limited warranty covers defects in materials and workmanship in this product.

What is Not Covered

This limited warranty does not cover any damage, deterioration or malfunction resulting from any alteration, modification, improper or unreasonable use or maintenance, misuse, abuse, accident, neglect, exposure to excess moisture, fire, improper packing and shipping (such claims must be presented to the carrier), lightning, power surges, or other acts of nature. This limited warranty does not cover any damage, deterioration or malfunction resulting from the installation or removal of this product from any installation, any unauthorized tampering with this product, any repairs attempted by anyone unauthorized by Kramer Electronics to make such repairs, or any other cause which does not relate directly to a defect in materials and/or workmanship of this product. This limited warranty does not cover cartons, equipment enclosures, cables or accessories used in conjunction with this product.

Without limiting any other exclusion herein, Kramer Electronics does not warrant that the product covered hereby, including, without limitation, the technology and/or integrated circuit(s) included in the product, will not become obsolete or that such items are or will remain compatible with any other product or technology with which the product may be used.

How Long this Coverage Lasts

The standard limited warranty for Kramer products is seven (7) years from the date of original purchase, with the following exceptions:

1. All Kramer VIA hardware products are covered by a standard three (3) year warranty for the VIA hardware and a standard three (3) year warranty for firmware and software updates; all Kramer VIA accessories, adapters, tags, and dongles are covered by a standard one (1) year warranty.
2. All Kramer fiber optic cables, adapter-size fiber optic extenders, pluggable optical modules, active cables, cable retractors, all ring mounted adapters, all Kramer speakers and Kramer touch panels are covered by a standard one (1) year warranty.
3. All Kramer Cobra products, all Kramer Calibre products, all Kramer Minicom digital signage products, all HighSecLabs products, all streaming, and all wireless products are covered by a standard three (3) year warranty.
4. All Sierra Video MultiViewers are covered by a standard five (5) year warranty.
5. Sierra switchers & control panels are covered by a standard seven (7) year warranty (excluding power supplies and fans that are covered for three (3) years).
6. K-Touch software is covered by a standard one (1) year warranty for software updates.
7. All Kramer passive cables are covered by a ten (10) year warranty.

Who is Covered

Only the original purchaser of this product is covered under this limited warranty. This limited warranty is not transferable to subsequent purchasers or owners of this product.

What Kramer Electronics Will Do

Kramer Electronics will, at its sole option, provide one of the following three remedies to whatever extent it shall deem necessary to satisfy a proper claim under this limited warranty:

1. Elect to repair or facilitate the repair of any defective parts within a reasonable period of time, free of any charge for the necessary parts and labor to complete the repair and restore this product to its proper operating condition. Kramer Electronics will also pay the shipping costs necessary to return this product once the repair is complete.
2. Replace this product with a direct replacement or with a similar product deemed by Kramer Electronics to perform substantially the same function as the original product.
3. Issue a refund of the original purchase price less depreciation to be determined based on the age of the product at the time remedy is sought under this limited warranty.

What Kramer Electronics Will Not Do Under This Limited Warranty

If this product is returned to Kramer Electronics or the authorized dealer from which it was purchased or any other party authorized to repair Kramer Electronics products, this product must be insured during shipment, with the insurance and shipping charges prepaid by you. If this product is returned uninsured, you assume all risks of loss or damage during shipment. Kramer Electronics will not be responsible for any costs related to the removal or re-installation of this product from or into any installation. Kramer Electronics will not be responsible for any costs related to any setting up this product, any adjustment of user controls or any programming required for a specific installation of this product.

How to Obtain a Remedy Under This Limited Warranty

To obtain a remedy under this limited warranty, you must contact either the authorized Kramer Electronics reseller from whom you purchased this product or the Kramer Electronics office nearest you. For a list of authorized Kramer Electronics resellers and/or Kramer Electronics authorized service providers, visit our web site at www.kramerav.com or contact the Kramer Electronics office nearest you.

In order to pursue any remedy under this limited warranty, you must possess an original, dated receipt as proof of purchase from an authorized Kramer Electronics reseller. If this product is returned under this limited warranty, a return authorization number, obtained from Kramer Electronics, will be required (RMA number). You may also be directed to an authorized reseller or a person authorized by Kramer Electronics to repair the product.

If it is decided that this product should be returned directly to Kramer Electronics, this product should be properly packed, preferably in the original carton, for shipping. Cartons not bearing a return authorization number will be refused.

Limitation of Liability

THE MAXIMUM LIABILITY OF KRAMER ELECTRONICS UNDER THIS LIMITED WARRANTY SHALL NOT EXCEED THE ACTUAL PURCHASE PRICE PAID FOR THE PRODUCT. TO THE MAXIMUM EXTENT PERMITTED BY LAW, KRAMER ELECTRONICS IS NOT RESPONSIBLE FOR DIRECT, SPECIAL, INCIDENTAL OR CONSEQUENTIAL DAMAGES RESULTING FROM ANY BREACH OF WARRANTY OR CONDITION, OR UNDER ANY OTHER LEGAL THEORY. Some countries, districts or states do not allow the exclusion or limitation of relief, special, incidental, consequential or indirect damages, or the limitation of liability to specified amounts, so the above limitations or exclusions may not apply to you.

Exclusive Remedy

TO THE MAXIMUM EXTENT PERMITTED BY LAW, THIS LIMITED WARRANTY AND THE REMEDIES SET FORTH ABOVE ARE EXCLUSIVE AND IN LIEU OF ALL OTHER WARRANTIES, REMEDIES AND CONDITIONS, WHETHER ORAL OR WRITTEN, EXPRESS OR IMPLIED. TO THE MAXIMUM EXTENT PERMITTED BY LAW, KRAMER ELECTRONICS SPECIFICALLY DISCLAIMS ANY AND ALL IMPLIED WARRANTIES, INCLUDING, WITHOUT LIMITATION, WARRANTIES OF MERCHANTABILITY AND FITNESS FOR A PARTICULAR PURPOSE. IF KRAMER ELECTRONICS CANNOT LAWFULLY DISCLAIM OR EXCLUDE IMPLIED WARRANTIES UNDER APPLICABLE LAW, THEN ALL IMPLIED WARRANTIES COVERING THIS PRODUCT, INCLUDING WARRANTIES OF MERCHANTABILITY AND FITNESS FOR A PARTICULAR PURPOSE, SHALL APPLY TO THIS PRODUCT AS PROVIDED UNDER APPLICABLE LAW.

IF ANY PRODUCT TO WHICH THIS LIMITED WARRANTY APPLIES IS A "CONSUMER PRODUCT" UNDER THE MAGNUSON-MOSS WARRANTY ACT (15 U.S.C.A. §2301, ET SEQ.) OR OTHER APPLICABLE LAW, THE FOREGOING DISCLAIMER OF IMPLIED WARRANTIES SHALL NOT APPLY TO YOU, AND ALL IMPLIED WARRANTIES ON THIS PRODUCT, INCLUDING WARRANTIES OF MERCHANTABILITY AND FITNESS FOR THE PARTICULAR PURPOSE, SHALL APPLY AS PROVIDED UNDER APPLICABLE LAW.

Other Conditions

This limited warranty gives you specific legal rights, and you may have other rights which vary from country to country or state to state.

This limited warranty is void if (i) the label bearing the serial number of this product has been removed or defaced, (ii) the product is not distributed by Kramer Electronics or (iii) this product is not purchased from an authorized Kramer Electronics reseller. If you are unsure whether a reseller is an authorized Kramer Electronics reseller, visit our web site at www.kramerav.com or contact a Kramer Electronics office from the list at the end of this document.

Your rights under this limited warranty are not diminished if you do not complete and return the product registration form or complete and submit the online product registration form. Kramer Electronics thanks you for purchasing a Kramer Electronics product. We hope it will give you years of satisfaction.



P/N:



2900-301015

Rev:



1



SAFETY WARNING

Disconnect the unit from the power supply before opening and servicing

For the latest information on our products and a list of Kramer distributors, visit our Web site where updates to this user manual may be found.

We welcome your questions, comments, and feedback.

The terms HDMI, HDMI High-Definition Multimedia Interface, and the HDMI Logo are trademarks or registered trademarks of HDMI Licensing Administrator, Inc. All brand names, product names, and trademarks are the property of their respective owners.