

KRAMER



USER MANUAL

MODEL:

691 HDBT 2.0 Optical Transmitter



691 Quick Start Guide

This guide helps you install and use your **691** for the first time.

Go to www.kramerav.com/downloads/691 to download the latest user manual and check if firmware upgrades are available.

Scan for full manual

Step 1: Check what's in the box

- ✓ 691 HDBT 2.0 Optical Transmitter
- ✓ 4 Rubber feet
- ✓ 1 Power adapter (12V DC)
- ✓ 1 Quick start guide

Step 2: Get to know your 691

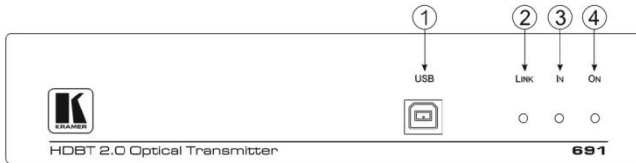

#	Feature	Function
1	USB Connector	Connect to the USB host for traffic extension, (for example, a laptop)
2	LINK LED	Lights green when the HDBT link is valid
3	IN LED	Lights green when an HDMI active signal device is connected
4	ON LED	Lights green when the device receives power

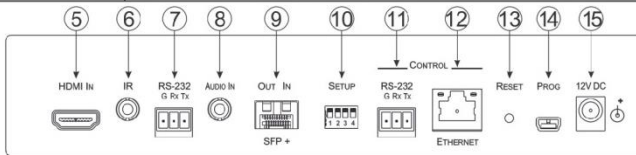

#	Feature	Function
5	HDMI IN Connector	Connect to the HDMI source
6	IR 3.5mm Mini Jack Connector	Connect to an external infrared transmitter or sensor for traffic extension
7	RS-232 3-pin Terminal Block	Connect to an RS-232 controller for traffic extension (for example, a PC to control the projector)
8	AUDIO IN 3.5mm Mini Jack	Connect to the stereo, analog audio source
9	OUT IN SFP+ Connector	Connect the fiber optic cable to the OUT IN SFP+ LC connector
10	SETUP 4-way DIP-switch	Sets the device behavior
11	CONTROL RS-232 3-pin Terminal Block	Connect to the serial controller to control this device
12	ETHERNET RJ-45 Connector	Connect to the Ethernet controller to control this device or to a LAN to extend network traffic to the receiver
13	RESET Switch	Press and hold while power-cycling the device to reset to factory default parameters
14	PROG Mini USB Connector	Connect to a PC to perform firmware upgrades
15	12V DC Power Connector	Connect to the supplied power adapter

Step 3: Install the 691

To mount the 691 in a rack, use an RK-1 rack adapter. Alternatively, attach the rubber feet to the underside of the 691 and place it on a table.

Step 4: Connect the inputs and outputs

Always switch OFF the power on each device before connecting it to your 691. For best results, we recommend that you always use Kramer high-performance cables to connect AV equipment to the 691.

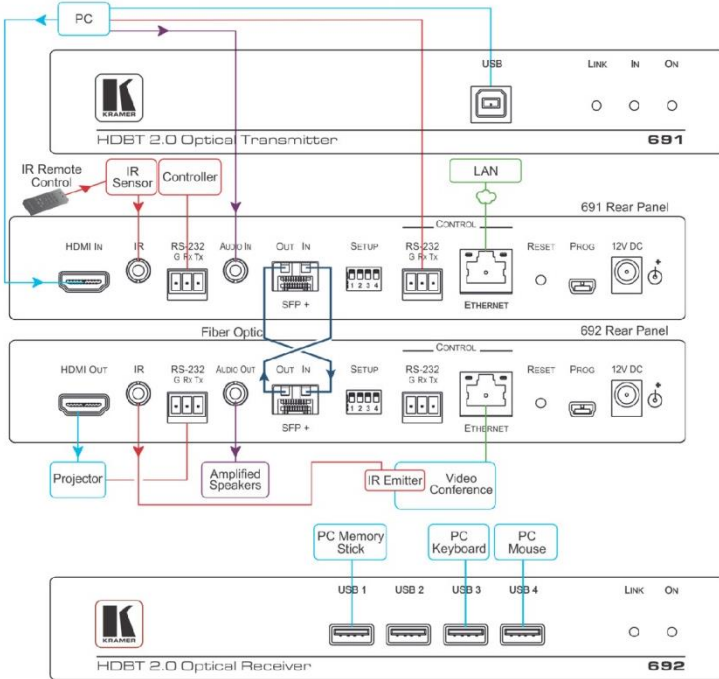

Always cross-connect the fiber connections, Rx OUT to Tx IN and Rx IN to Tx OUT, as transmission is carried on simplex fiber strands.

To install the OSP SFP+ transceiver:

1. Make sure the bail is pushed up, in the closed position.
2. Insert the OSP SFP+ transceiver into the relevant optical device SFP+ slot and push it in until it clicks.

Remove the protective cap and store it in a safe place for future use.

Warning: Connecting the OSP SFP+ connector to an LC/APC fiber connector may cause poor performance and damage the connector!

Refer to www.kramerav.com/downloads/OSP-MM1 for more information.

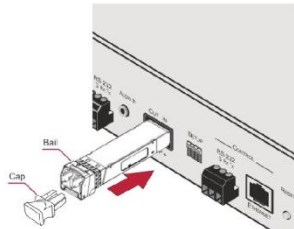

Warning: Class 1 Laser Product

- Invisible laser radiation present.
- Avoid long-term viewing of laser.
- Avoid the use of magnifying viewing aids or instruments (such as binoculars, telescopes, microscopes and magnifying lenses, but not spectacles or contact lenses).
- Avoid placing optical devices in the emitted beam that could cause the concentration of the laser radiation to be increased.

RJ-45 Pinout:

For the Ethernet connectors, see the proper wiring diagram

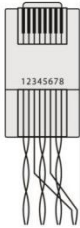

PIN EIA /TIA 568B	
PIN	Wire Color
1	Orange / White
2	Orange
3	Green / White
4	Blue
5	Blue / White
6	Green
7	Brown / White
8	Brown

SETUP DIP-Switches

A DIP-switch that is down is on, up is off. Changes to the DIP-switches only take effect on power-up. After changing a switch, reboot the device.

#	Function	Status
1	For future use	
2	Audio source priority	Off—Embedded audio (factory default) On—Analog audio
3	EDID lock	Off—Automatic EDID acquisition (factory default) On—Lock (locks the current EDID so that changes on the output do not result in changes to the EDID)
4	Audio mode selection	Off—Auto (factory default) On—Manual

Step 5: Connect the power

Connect the power adapter to the 691 and plug the adapter into the mains electricity.

Safety Instructions



- Caution:** There are no operator serviceable parts inside the unit
- Warning:** Use only the Kramer Electronics power supply that is provided with the unit
- Warning:** Disconnect the power and unplug the unit from the wall before installing
- See www.KramerAV.com for updated safety information.

Step 6: Control the 691 via the:

Embedded Web pages:

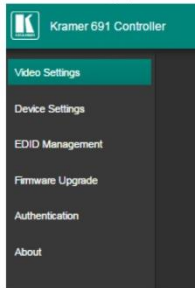

RS-232 and Ethernet:

RS-232			
Protocol 3000			
Baud Rate:	115,200	Stop Bits:	1
Data Bits:	8	Parity:	None
Command format:	ASCII		
Example (get device model name):	#model?<cr>		
TCP/IP Parameters			
IP Address:	192.168.1.39	UDP Port #:	50000
Subnet mask:	255.255.000.000	TCP Port #:	5000
Default gateway:	192.168.0.1		
Full Factory Reset			
Rear panel button:	Press and hold to reset to factory default parameters		
P3K command:	#factory<cr>		
Embedded Web pages:	Select Device Settings page and click Factory reset		

Default Parameters	Value
Name:	KRAMER_
Model:	691
Audio delay input switching on new signal:	Immediate
Audio delay input switching on signal loss (leave 5V on):	5 seconds
Audio delay input switching on cable unplug:	Immediate
Video delay power off 5V on signal loss:	15 minutes
HDCP:	Follow output
Web Logon credentials:	Name: Admin; Password: Admin

Contents

1	Introduction	1
2	Getting Started	2
2.1	Achieving the Best Performance	2
2.2	Safety Instructions	2
2.3	Recycling Kramer Products	3
3	Overview	4
4	Defining the 691 HDBT 2.0 Optical Transmitter	6
5	Connecting the 691 HDBT 2.0 Optical Transmitter	8
5.1	Using the OSP SFP+ Module	12
5.2	Connecting to 691 via RS-232	15
5.3	Connecting 691 via the Ethernet Port	16
6	Principles of Operation	20
6.1	Audio Output	20
6.2	Video Output and Audio Switching Timeouts	20
6.3	Controlling A/V Equipment via an IR Remote Control	20
7	Configuring the 691 HDBT 2.0 Optical Transmitter	23
8	Using the Embedded Web Pages	24
8.1	Browsing the 691 Web Pages	24
8.2	Setting the Sleep Mode, HDCP Mode and Audio Switching Delay Time	26
8.3	Setting Device Parameters	28
8.4	Managing the EDID	32
8.5	Authentication Page	34
8.6	Viewing the About Page	35
9	Firmware Upgrade	36
10	Technical Specifications	37
10.1	Default Communication Parameters	39
10.2	Default Parameters	39
10.3	Default EDID	39
11	Protocol 3000	42
11.1	Understanding Protocol 3000	43
11.2	Kramer Protocol 3000 Syntax	45
11.3	Protocol 3000 Commands	46

Figures

Figure 1: 691 Front Panel	6
Figure 2: 691 Rear Panel	7
Figure 3: Connecting the Fiber Optic Cable	9
Figure 4: Connecting the 691 and 692	11
Figure 5: System Layout Example for Optical Reach Evaluation	13
Figure 6: Inserting the Transceiver Module	14
Figure 7: RS-232 Connection	15
Figure 8: Local Area Connection Properties Window	17
Figure 9: Internet Protocol Version 4 Properties Window	18
Figure 10: Internet Protocol Version 6 Properties Window	18
Figure 11: Internet Protocol Properties Window	19

Figure 12: Controlling a Blu-ray Disk Player via the 692 Receiver	21
Figure 13: Controlling a Projector via the 691 Transmitter	22
Figure 14: 691 DIP-Switch	23
Figure 15: Entering Logon Credentials	25
Figure 16: Video & Audio Settings Page	26
Figure 17: The Device Settings Page	29
Figure 18: Turning DHCP Off Dialog Box	29
Figure 19: Turning DHCP On Warning	30
Figure 20: The EDID Management Page	33
Figure 21: The EDID Message	33
Figure 22: The Authentication Page	34
Figure 23: The About Page	35

1 Introduction

Welcome to Kramer Electronics! Since 1981, Kramer Electronics has been providing a world of unique, creative, and affordable solutions to the vast range of problems that confront video, audio, presentation, and broadcasting professionals on a daily basis. In recent years, we have redesigned and upgraded most of our line, making the best even better!

Our 1,000-plus different models now appear in 14 groups that are clearly defined by function: GROUP 1: Distribution Amplifiers; GROUP 2: Switchers and Routers; GROUP 3: Control Systems; GROUP 4: Format/Standards Converters; GROUP 5: Range Extenders and Repeaters; GROUP 6: Specialty AV Products; GROUP 7: Scan Converters and Scalers; GROUP 8: Cables and Connectors; GROUP 9: Room Connectivity; GROUP 10: Accessories and Rack Adapters; GROUP 11: Sierra Video Products; GROUP 12: Digital Signage; GROUP 13: Audio; and GROUP 14: Collaboration.

Congratulations on purchasing your Kramer **691** HDBT 2.0 Optical Transmitter which is part of the Kramer Video and Audio Distribution System and is ideal for:

- Ultra-long signals extension for:
 - Multi-room and inter-building ultra-long connectivity.
 - Large dividable auditoriums and lecture halls.
- Highly secured and reliable signals ultra-long extension for:
 - Governmental applications.
 - Medical applications.
 - Rental and staging applications.



691 HDBT 2.0 Optical Transmitter and **692** HDBT 2.0 Optical Receiver are standard compliant and can be connected to other HDBT-certified transmitters and receivers.

2 Getting Started

We recommend that you:

- Unpack the equipment carefully and save the original box and packaging materials for possible future shipment.
- Review the contents of this user manual.



Go to www.kramerav.com/downloads/691 to check for up-to-date user manuals, application programs, and to check if firmware upgrades are available (where appropriate).

2.1 Achieving the Best Performance

To achieve the best performance:

- Use only good quality connection cables (we recommend Kramer high-performance, high-resolution cables) to avoid interference, deterioration in signal quality due to poor matching, and elevated noise levels (often associated with low quality cables).
- Do not secure the cables in tight bundles or roll the slack into tight coils.
- Avoid interference from neighboring electrical appliances that may adversely influence signal quality.
- Position your **691** HDBT 2.0 Optical Transmitter away from moisture, excessive sunlight and dust.



This equipment is to be used only inside a building. It may only be connected to other equipment that is installed inside a building.

2.2 Safety Instructions



Caution: There are no operator serviceable parts inside the unit.

Warning: Use only the power cord that is supplied with the unit.

Warning: Disconnect the power and unplug the unit from the wall before installing.

2.3 Recycling Kramer Products

The Waste Electrical and Electronic Equipment (WEEE) Directive 2002/96/EC aims to reduce the amount of WEEE sent for disposal to landfill or incineration by requiring it to be collected and recycled. To comply with the WEEE Directive, Kramer Electronics has made arrangements with the European Advanced Recycling Network (EARN) and will cover any costs of treatment, recycling and recovery of waste Kramer Electronics branded equipment on arrival at the EARN facility. For details of Kramer's recycling arrangements in your particular country go to our recycling pages at www.kramerav.com/support/recycling/.

3 Overview

691 is a high-performance HDBaseT 2.0 fiber transmitter for ultra-reach extension of 4K60Hz (4:2:0) HDMI, USB 2.0, Ethernet, RS-232, IR and stereo audio signals over either multi-mode or single-mode fiber optic. **691** converts all the input signals into the transmitted HDBaseT 2.0 signal over fiber optic cable. The extended line receiver, such as Kramer **692**, converts the HDBaseT 2.0 signal back to 4K60Hz (4:2:0) HDMI, USB 2.0, Ethernet, RS-232, IR and stereo audio output signals.

691 extends video signals to up to 33km (20.5 miles) over single-mode fiber at up to 4K@60Hz (4:2:0) resolution.

The **691** transmitter features:

- High performance standard fiber extender – HDBaseT 2.0 fiber transmitter for providing ultra-reach signals over either multi-mode or single-mode optical fiber infrastructures, using Kramer pluggable OSP SFP+ units. **691** is a standard fiber extender that can be connected to any market-available HDBaseT-compliant extension product.



To ensure Kramer support and warranty of the **691** product, use only Kramer's certified high-performance OSP SFP+ pluggable optical modules:

OSP-MM1: Optical MM 850nm 10G SFP+ Transceiver

OSP-SM10: Optical SM 1310nm 10G SFP+ Transceiver



For optimum extension reach and performance, use Kramer's OSP SFP+ units and recommended Kramer cables. Non-Kramer cables may not reach these ranges.

Note that the maximum transmission reach is typical and may vary depending on fiber cables performance, signal resolution, connectors and splicing optical losses, modal or chromatic dispersion, and similar optical-related factors.

- HDMI signal extension – HDMI 2.0 and HDCP 1.4 compliant. Supports deep color, x.v.Color™, lip sync, HDMI uncompressed audio channels, Dolby TrueHD, DTS-HD, 2K, 4K, and 3D. EDID and CEC signals are passed through from the source to the display.

- I-EDIDPro™ Kramer Intelligent EDID Processing™ – Intelligent EDID handling, processing and pass-through algorithm that ensures Plug-and-Play operation for HDMI source and display systems.
- USB extension – USB 2.0 interface data flows in both directions, allowing extension of HID (Human Interface Devices) peripheral devices, such as a mouse or a keyboard. High-bandwidth USB peripheral devices, such as USB isochronous streaming cameras and audio devices, transfer data continuously and periodically. Delivery of their transferred data is not guaranteed by the USB standard and is subject to both USB and HDBaseT line bandwidth management limitations. When such devices are connected, check their functionality to ensure bandwidth limitations are not exceeded.
- Ethernet extension – Ethernet interface data flows in both directions allowing extension of up to 100Mbps Ethernet connectivity for LAN communication and device control.
- Bidirectional RS-232 extension – Serial interface data flows in both directions allowing data transmission and device control.
- Bidirectional infrared extension – IR interface data flows in both directions allowing remote control of peripheral devices located at either end of the extended line.
- Audio embedding (Adding) – A selectable analog unbalanced stereo audio input is converted into a digital signal and added (embedded) to the transmitted HDMI signal, replacing the embedded HDMI audio input signal. This enables embedding a selectable audio source over HDMI. For example, a presenter can display a video clip and temporarily override the audio of the source media with another audio source, such as from a microphone.
- Cost-effective maintenance – Status LED indicators for the HDMI input and HDBT output link facilitate easy local troubleshooting. Remote device management via built-in web UI and RS-232 connection enable simple device maintenance. Kramer Network support provides remote device and network management. Local and remote firmware upgrade via mini-USB, RS-232 or Ethernet connection and the K-Upload tool ensure lasting, field-proven deployment.
- Easy installation – Half 19" 1U rack mountable fan-less enclosure enables side-by-side mounting of 2 units in a 1U rack space.

4 Defining the 691 HDBT 2.0 Optical Transmitter

[Figure 1](#) defines the front panel of the **691**.

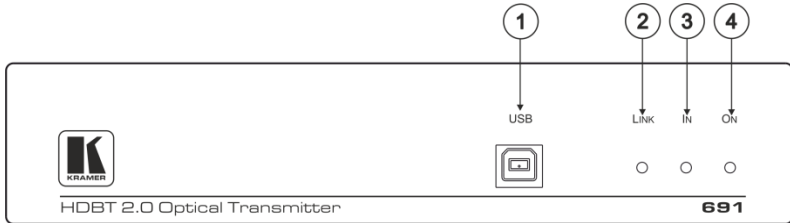

Figure 1: 691 Front Panel

#	Feature	Function
1	USB Connector	Connect to the USB host for traffic extension (for example, a laptop).
2	LINK LED	Lights green when the HDBT link is valid.
3	IN LED	Lights green when an HDMI active signal device is connected.
4	ON LED	Lights green when the device receives power.

[Figure 2](#) defines the rear panel of the **691**.

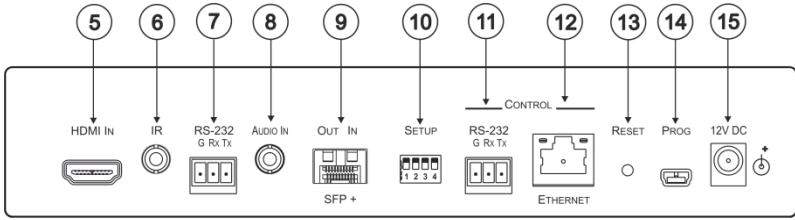

Figure 2: 691 Rear Panel

#	Feature	Function	
5	HDMI IN Connector	Connect to an HDMI source.	
6	IR 3.5mm Mini Jack Connector	Connect to an external infrared transmitter or sensor for traffic extension.	
7	RS-232 3-pin Terminal Block	Connect to an RS-232 controller for traffic extension (for example, a PC to control the projector on the receiver side).	
8	AUDIO IN 3.5mm Mini Jack	Connect to the stereo, unbalanced, analog audio source.	
9	OUT IN SFP+ Connector opening	Plug the Kramer certified optical SFP+, and connect the fiber optic cable to the OUT IN SFP+ LC connector (OSP-MM1 or OSP-SM10 , purchased separately, see Section 5.1).	
10	SETUP 4-way DIP-switch	Sets the device behavior, (see Section 7).	
11	CONTROL	RS-232 3-pin Terminal Block	Connect to a serial controller to control this device.
12		ETHERNET RJ-45 Connector	Connect to an Ethernet controller to control this device or to a LAN to extend network traffic to the receiver.
13	RESET Switch	Press and hold to reset settings to factory default values.	
14	PROG Mini USB Connector	Use for firmware upgrade.	
15	12V DC Power Connector	Connect to the supplied power adapter.	

5 Connecting the 691 HDBT 2.0 Optical Transmitter



Always switch off the power to each device before connecting it to your **691**. After connecting your **691**, connect the power to and switch on each device.

You can use the **691** HDBT 2.0 Optical Transmitter and a compatible receiver, for example, the Kramer **692** HDBT 2.0 Optical Receiver to configure a paired HDMI transmitter/receiver system, as shown in the example in [Figure 4](#).

To connect the 691 HDBT 2.0 Optical Transmitter:

On the 691 transmitter:

1. Connect an HDMI source, (for example, a laptop) to the HDMI IN connector.
2. Connect an RS-232 serial controller to the RS-232 3-pin terminal block for traffic extension, to control the projector (on the receiver side).
3. Connect a stereo analog audio source (for example, the audio output of a PC) to the AUDIO IN 3.5mm mini jack for traffic extension.
4. Connect the USB port on a PC to the USB port on the front panel of the **691** for traffic extension.
5. Connect an external IR emitter to the IR 3.5mm mini jack for traffic extension.
6. Insert the **OSP-MM1/OSP-SM10** transceiver module into the OUT/IN SFP+ opening, see [Section 5.1](#).

7. Connect the OUT IN SFP+ LC(UPC) connector (see [Section 5.1](#)) to the OUT/IN LC(UPC) fiber optic cable extension towards the **692** receiver.



Always cross-connect the fiber connections, Rx OUT to Tx IN and Rx IN to Tx OUT, as transmission is carried on simplex fiber strands.

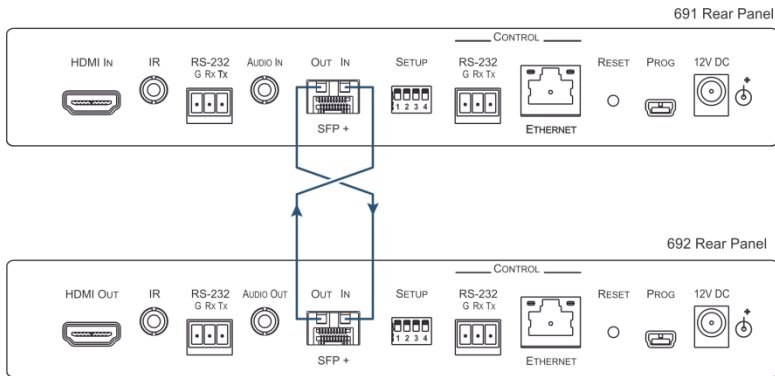

Figure 3: Connecting the Fiber Optic Cable



Always inspect and clean the connectors before you make a connection.

Always plug or unplug the fiber by holding the connector housing.

Never touch the end face of the optic fiber connectors.

8. Connect the supplied power adapter to the power socket and plug the adapter into the mains electricity (not shown in [Figure 4](#)).

On the **692** receiver:

9. Connect the HDMI OUT connector to an HDMI acceptor, (for example, a projector).
10. Connect the **RS-232** 3-pin terminal block to the device to be controlled (for example, the projector that is controlled by a serial controller which is connected to **691**).
11. Connect the AUDIO OUT 3.5mm mini jack to an audio acceptor, (for example, amplified speakers).

12. Connect the USB ports (for example, USB keyboard and mouse and a USB external memory device).
13. Connect the IR 3.5mm mini jack to an IR sensor.
14. Insert the recommended **OSP SFP+** modules (make sure the bail is closed and in the upward position) into the IN OUT SFP+ slot and push it in until it clicks, see [Section 5.1](#).
15. Remove the protective cap and keep for future use.
16. Connect the OUT IN SFP+ LC(UPC) connector to the IN/OUT LC(UPC) connector of the fiber optic cable extension towards the **691** transmitter.



Always cross-connect the fiber connections, Rx OUT to Tx IN and Rx IN to Tx OUT, as transmission is carried on simplex fiber strands (see [Figure 3](#)).



Always inspect and clean the connectors before you make a connection.
Always plug or unplug the fiber by holding the connector housing.
Never touch the end face of the fiber connectors.

17. Connect the supplied power adapter to the power socket and plug the adapter into the mains electricity (not shown in [Figure 4](#)).

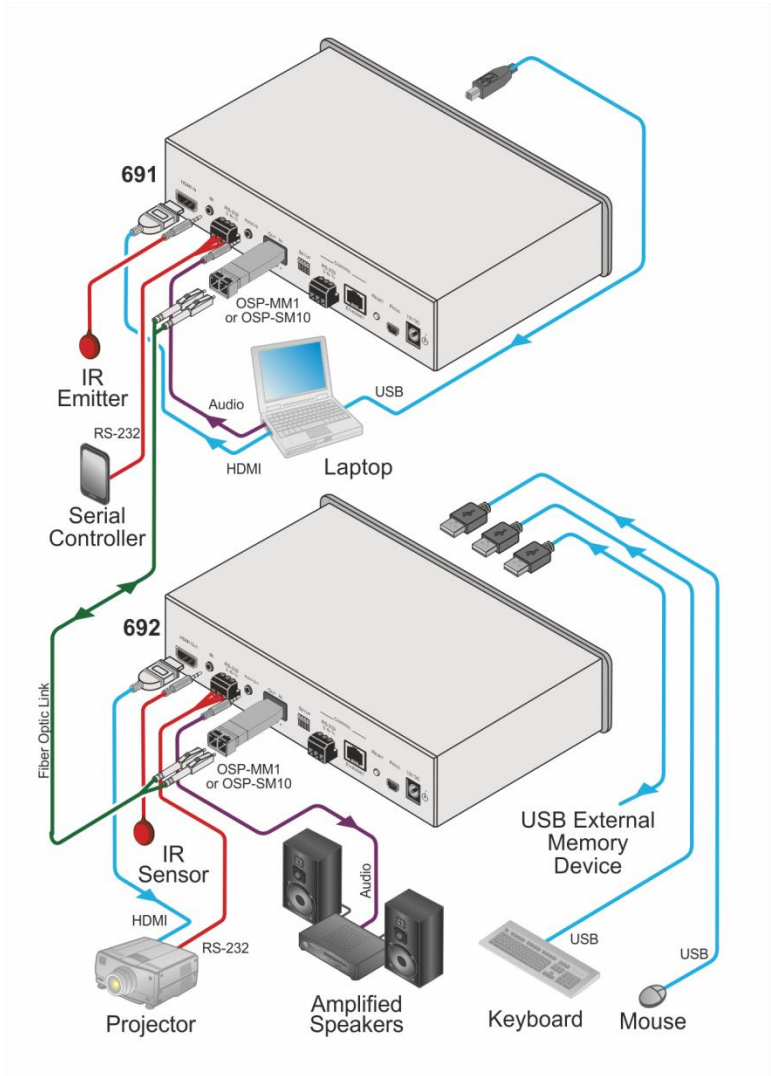

Figure 4: Connecting the 691 and 692

5.1 Using the OSP SFP+ Module

Before connecting the **691** to an optical receiver, you need to insert the same type of SFP+ transceiver both into the SFP+ opening on the **691** and the compatible receiver.

Two types of Kramer SFP+ optical transceiver modules are available:

- **OSP-MM1**: Optical MM 850nm 10G SFP+ Transceiver
- **OSP-SM10**: Optical SM 1310nm 10G SFP+ Transceiver

Before deciding which transceiver module to use, consider the infra-structure of the installation area, the desired distance, optical loss budget and typical expected loss.



Use the same type of SFP+ optical transceiver module both on the **691** transmitter and the receiver (for example **692**).

The following table defines various typical Fiber cable characteristics, used for optical reach evaluation:

Cable Category	Core Diameter [µm]	Wavelength	Fiber Loss [dB/km]	Connector Loss [dB]	Splice Loss [dB]
MM OM1 [G.651.1]	62.5/125	850nm	3	Typical: 0.3 Max.: 0.75	0.3
MM OM2 [G.651.1]	50/125		2.5		
MM OM3 [G.651.1, Laser Optimized]					
MM OM4 [G.651.1, Laser Optimized]					
MM OM5	8		1310nm		
SM OS1 [G.652A/B]					
SM OS2 [G.652C/D]			0.4		



OSP-MM1 and **OSP-SM10** modules are designed to be used only with LC(UPC) **blue** or LC(PC) **white** connectors. Using an LC(APC) **green** connector with the module causes poor performance and can damage the module connector.

For all other cable connections that do not connect directly to the **OSP-MM1** or **OSP-SM10** modules, such as the optical patch panel and bulk cables illustrated in [Figure 5](#), we recommend using Angled Physical Contact (APC) **green** connectors for improved end-to-end reach performance.



When using OSP modules consider the following:

- Modules are Class 1 Laser products.
- There may be Invisible laser radiation present.
- Avoid long-term viewing of laser.
- Avoid the use of magnifying viewing aids or instruments (such as binoculars, telescopes, microscopes and magnifying lenses, but not spectacles or contact lenses).
- Avoid placing optical devices in the emitted beam that could cause the concentration of the laser radiation to be increased.

5.1.1 Optical Reach Evaluation

The following examples show how to calculate dB loss during optical signal transmission over fiber optical infrastructure.

In the optical system layout example, illustrated in [Figure 5](#):

- **691** and **692** are connected to a patch panel via 100m patch cords.
- There are 6 connectors and no splices.

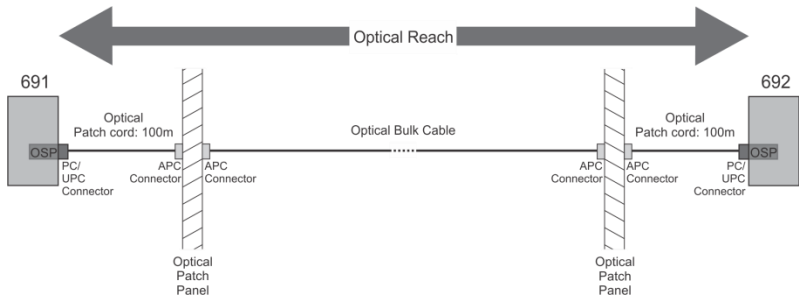

Figure 5: System Layout Example for Optical Reach Evaluation

For multi-mode lines (MM OM3 cable category, as defined in the table on page [12](#)):

- Maximum loss budget is: 8.6dB.
- Typical loss per connector is 0.3dB.
- Typical loss for each patch cord (100m) is 0.25dB.
- Fiber optic loss is 2.5 dB/km.

Multi-mode bulk line budget is: $8.6 - (0.3 \times 6 + 0.25 \times 2) = 6.3\text{dB}$.

Evaluated bulk line length is: $6.3 / 2.5 = 2.5\text{km}$.

For single-mode lines (SM OS1 cable category, as defined in the table on page 12):

- Maximum loss budget is: 11.9dB.
- Typical loss per connector is 0.3dB.
- Typical loss for each patch cord (100m) is 0.1dB.
- Fiber optic loss is 1 dB/km.

Single-mode bulk line loss budget is: $11.9 - (0.3 \times 6 + 0.1 \times 2) = 9.9\text{dB}$.

Evaluated bulk line length is: $9.9 / 1 = 9.9\text{km}$.

5.1.2 Inserting the SFP+ Module

To insert the SFP+ module:

1. Make sure the bail is pushed up, in the closed position.
2. Insert the **OSP-MM1/OSP-SM10** into the IN OUT SFP+ slot and push it in until it clicks.

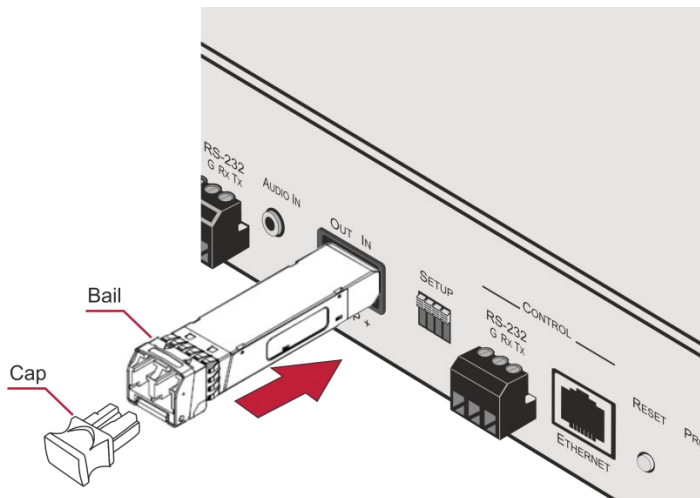

Figure 6: Inserting the Transceiver Module

3. Remove the protective cap and keep for future use.



For more information, see the **OSP-MM1/OSP-SM10** documentation available at www.kramerav.com/product/osp-mm1.

5.2 Connecting to 691 via RS-232

The **691** features two RS-232 3-pin terminal block connectors:

- RS-232 to pass data to and from the machines that are connected to the receiver.
- RS-232 CONTROL to control the **691**.

Connect the RS-232 terminal block on the rear panel of the **691** to a PC/controller, as follows (see [Figure 7](#)):

- TX pin to Pin 2
- RX pin to Pin 3
- GND pin to Pin 5

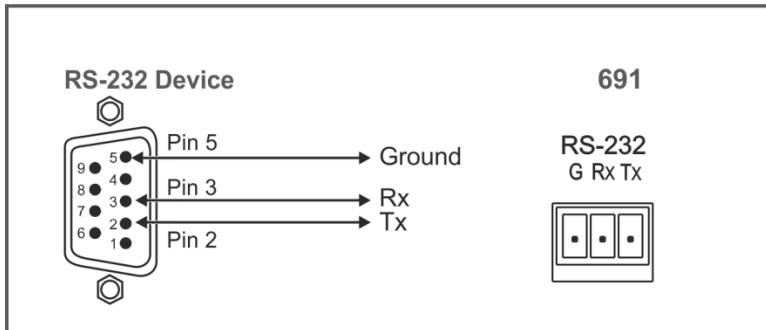

Figure 7: RS-232 Connection

5.3 Connecting 691 via the Ethernet Port

You can connect to the **691** via Ethernet using either of the following methods:

- Directly to the PC using a crossover cable (see [Section 5.3.1](#)).
- Via a network hub, switch, or router, using a straight-through cable (see [Section 5.3.1.1](#)).



If you want to connect via a router and your IT system is based on IPv6, speak to your IT department for specific installation instructions.

5.3.1 Connecting the Ethernet Port Directly to a PC

You can connect the Ethernet port of the **691** directly to the Ethernet port on your PC using a crossover cable with RJ-45 connectors.



This type of connection is recommended for identifying the **691** with the factory configured default IP address.

After connecting the **691** to the Ethernet port, configure your PC as follows:

1. Click **Start > Control Panel > Network and Sharing Center**.
2. Click **Change Adapter Settings**.
3. Highlight the network adapter you want to use to connect to the device and click **Change settings of this connection**.

The Local Area Connection Properties window for the selected network adapter appears as shown in [Figure 8](#).

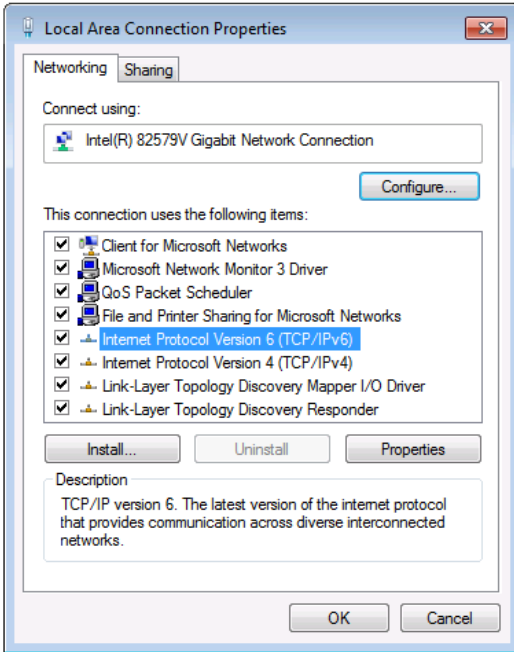

Figure 8: Local Area Connection Properties Window

4. Highlight either **Internet Protocol Version 6 (TCP/IPv6)** or **Internet Protocol Version 4 (TCP/IPv4)** depending on the requirements of your IT system.
5. Click **Properties**.
The Internet Protocol Properties window relevant to your IT system appears as shown in [Figure 9](#) or [Figure 10](#).

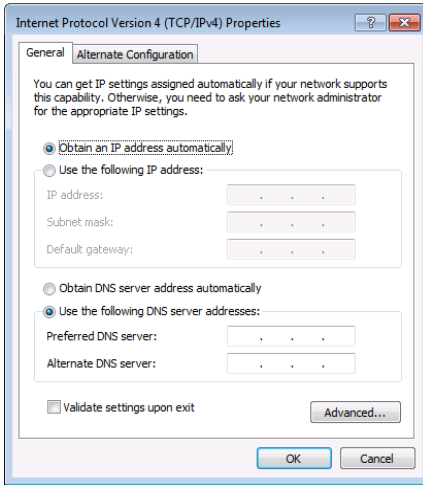

Figure 9: Internet Protocol Version 4 Properties Window

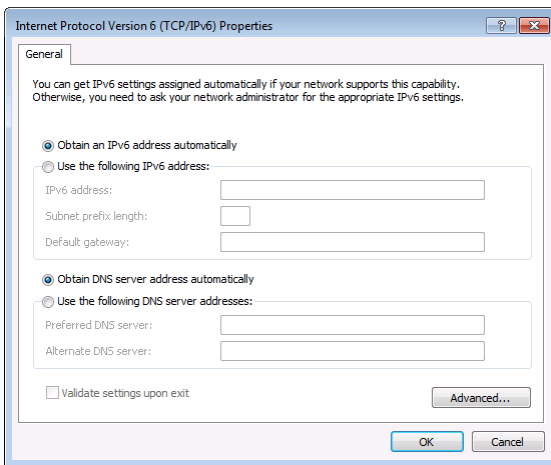

Figure 10: Internet Protocol Version 6 Properties Window

6. Select **Use the following IP Address** for static IP addressing and fill in the details as shown in [Figure 11](#).

For TCP/IPv4 you can use any IP address in the range 192.168.1.1 to 192.168.1.255 (excluding 192.168.1.39) that is provided by your IT department.

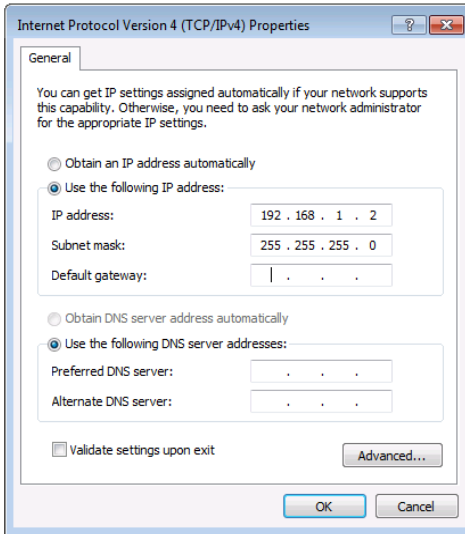

Figure 11: Internet Protocol Properties Window

7. Click **OK**.

8. Click **Close**.

5.3.1.1 Connecting the ETHERNET Port via a Network Hub or Switch

You can connect the Ethernet port of the **691** to the Ethernet port on a network hub or network router, via a straight-through cable with RJ-45 connectors.

6 Principles of Operation

This section describes the audio output setup conditions, the video and audio timeouts and AV IR control.

6.1 Audio Output

The audio source that is routed to the output depends on the SETUP DIP-switch settings (see [Section 7](#)) and also on whether there is an audio signal on the input ports. The audio output follows the rules described in the following table.

HDMI Audio Detected	Analog Audio Detected	DIP-switch 4	DIP-switch 2	Audio Out
N/A	N/A	Manual (On)	HDMI (Off)	HDMI
N/A	N/A	Manual (On)	Analog (On)	Analog
Yes	No	Auto (Off)	N/A	HDMI
Yes	Yes	Auto (Off)	HDMI (Off)	HDMI
Yes	Yes	Auto (Off)	Analog (On)	Analog
No	Yes	Auto (Off)	N/A	Analog
No	No	Auto (Off)	N/A	No audio

6.2 Video Output and Audio Switching Timeouts

The device can automatically turn off the video signal output and audio source switching after definable intervals following the loss of the input signals or unplugging of the input cables. These delays can be set using the **691** embedded web-pages settings (see [Section 8.2](#)) or Protocol 3000 commands (see [Section 11.3](#)).

6.3 Controlling A/V Equipment via an IR Remote Control

Since the IR connection between the **691** transmitter and **692** receiver is bidirectional, you can use a remote control transmitter (that is used for controlling a peripheral device, for example, a Blu-ray disk player) to send commands from either end of the transmitter or receiver system. To use a remote control transmitter, connect the Kramer IR sensor cable at one end and the Kramer IR emitter cable at the other end. Two sample cases are presented below.

The example in [Figure 12](#) illustrates how to control a **691**-connected Blu-ray disk player using a remote control via the remote **692** receiver. The IR sensor cable is connected to the **692** and an IR emitter cable is connected between the **691** and the Blu-ray disk player. The Blu-ray disk player remote control sends an IR command while pointed at the external IR sensor. The IR signal is passed over the fiber optic link and the IR emitter to the Blu-ray disk player which responds to the command sent.

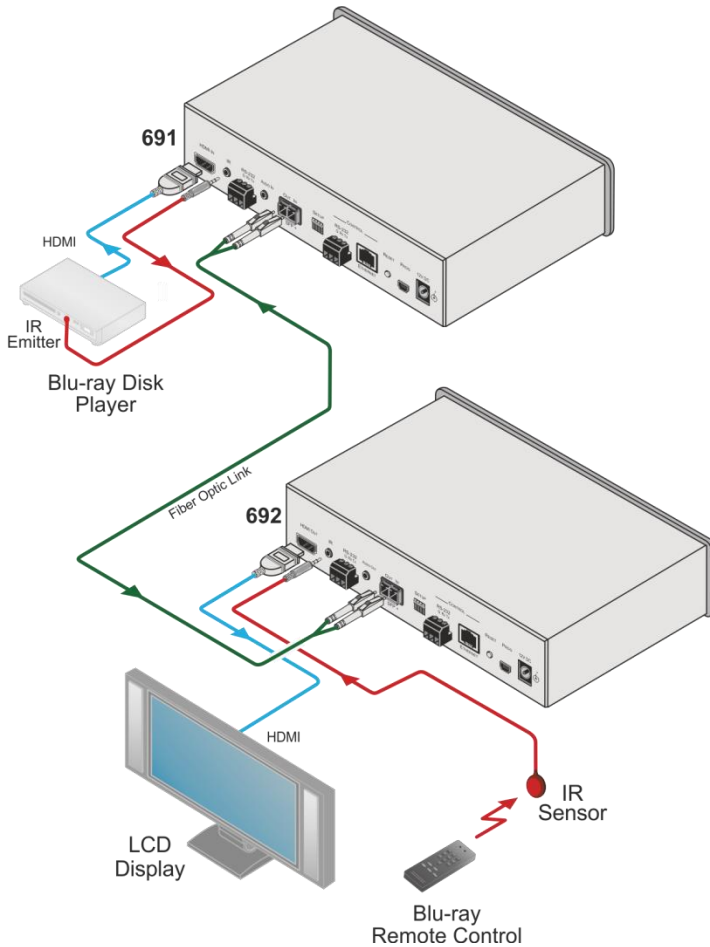

Figure 12: Controlling a Blu-ray Disk Player via the 692 Receiver

The example in [Figure 13](#) illustrates how to remotely control the projector that is connected to **692** using an IR remote control, via the **691**. The IR sensor cable is connected to the **691** and the IR emitter cable is connected between the **692** and the projector. The projector remote control sends an IR command while pointed at the external IR sensor. The IR signal is passed over the fiber optic link and the IR emitter cable to the projector which responds to the command sent.

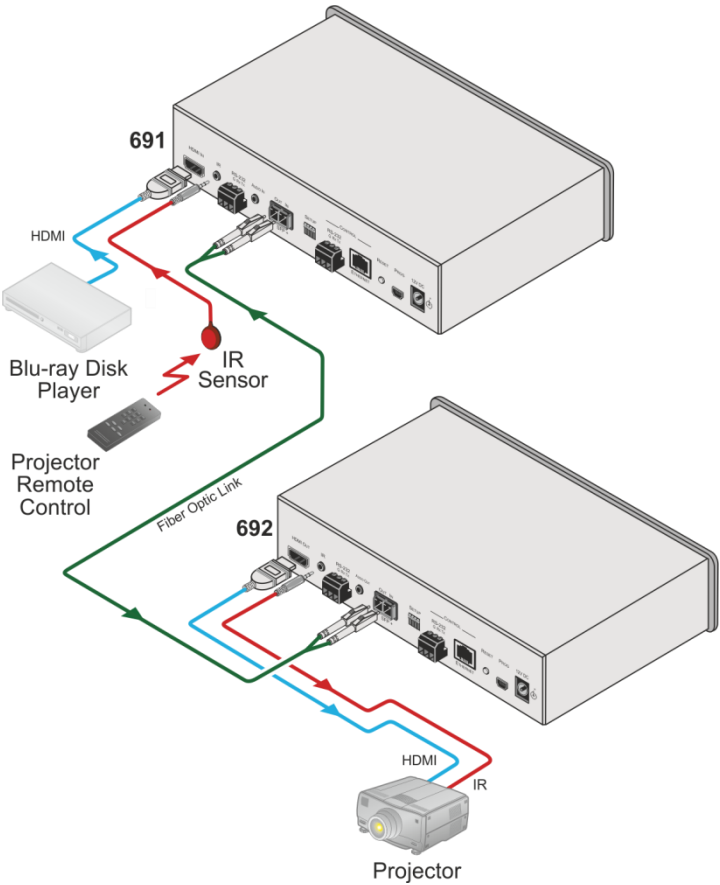

Figure 13: Controlling a Projector via the 691 Transmitter

7 Configuring the 691 HDBT 2.0 Optical Transmitter

The 4-way SETUP DIP-switch on the rear panel is used to configure the **691** according to the table below.



Figure 14: 691 DIP-Switch



Note that all the DIP-switches are set to off (up) by default.

#	Function	Status
1	For future use	
2	Audio source priority	Off (up) – HDMI embedded audio (factory default). On (down) – Analog audio.
3	EDID lock	Off (up) – Automatic EDID acquisition (factory default). On (down) – Lock (locks the current EDID so that changes on the output do not result in changes to the EDID).
4	Audio mode selection	Off (up) – Auto (factory default). On (down) – Manual.



Changes to the DIP-switches only take effect on power-up. After changing a switch, reboot the device.

8 Using the Embedded Web Pages

The **691** can be managed remotely using its embedded Web pages. The Web pages are accessed using a web browser and an Ethernet connection.

Before attempting to connect:

- Connect the **691** via the Ethernet port.
- Make sure that your browser is supported (see [Section 9](#)).

The **691** Web pages enable performing the following:

- Setting sleep mode, HDCP and audio switching delay time (see [Section 8.2](#)).
- Setting the device parameters and performing a factory reset (see [Section 8.3](#)).
- Managing the EDID (see [Section 8.4](#)).
- Authentication (see [Section 8.5](#)).
- Viewing the Web version and other Kramer details (see [Section 8.6](#)).

8.1 Browsing the 691 Web Pages



In the event that a Web page does not update correctly, clear your web browser's cache by pressing CTRL+F5.

Only one instance of the Web page can be open at a time.

To browse the 691 Web pages:

1. Open your Internet browser.
2. Type the IP address of the device in the address bar of your browser. For example, the default IP address:



The Authentication window appears.



To connect the **691** when DHCP is enabled (see [Section 8.3](#)), you must identify the IP address that has been automatically assigned to the **691**. To discover the IP address of **691**, use **K-LAN Configurator**, available for download from our website at www.kramerav.com.

You can also use the host name (Unit Name in Device Settings page): **691-xxxx**, where xxxx are the last four digits of the serial number of the device.

3. Enter the user name (Admin, Admin, by default).

A screenshot of a web browser's authentication dialog box. The title bar reads "Authentication Required" with a close button (X) in the top right corner. The main text says "http://192.168.1.39 requires a username and password. Your connection to this site is not private." Below this, there are two input fields: "User Name:" with the text "Admin" entered, and "Password:" with four asterisks "****" entered. At the bottom, there are two buttons: "Log In" and "Cancel".

Authentication Required

http://192.168.1.39 requires a username and password.
Your connection to this site is not private.

User Name:

Password:

Figure 15: Entering Logon Credentials

The Video & Audio Settings page appears:

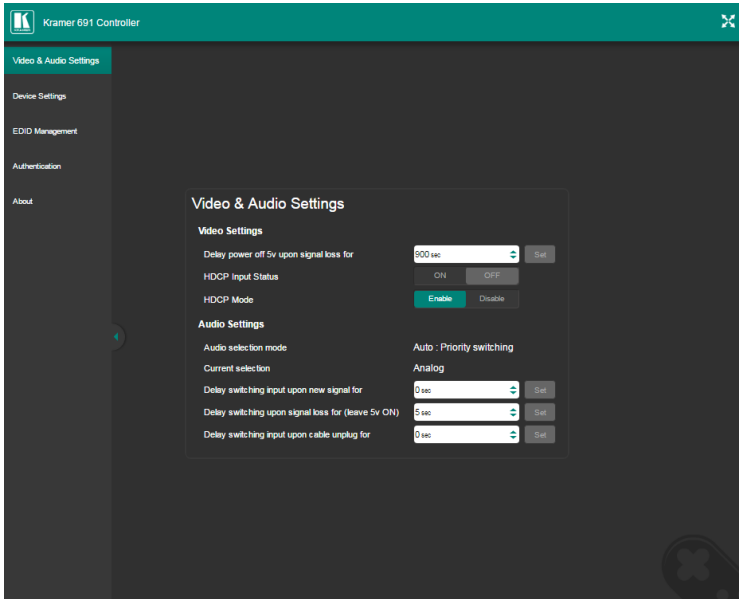

Figure 16: Video & Audio Settings Page

4. Click the arrow button to show/hide the Navigation pane on the left.

8.2 Setting the Sleep Mode, HDCP Mode and Audio Switching Delay Time

The Video & Audio Settings page lets you set the delay time for turning off the 5V output following an input signal loss, set the HDCP mode and the audio switching delay time.

To set the sleep mode:

1. In the Navigation pane, click **Video & Audio Settings**. The Video & Audio Settings page appears (see [Figure 16](#)).

2. Set the video delay time in seconds.
3. Click **Set**.



The delay time is detected by the receiver. For example, the receiver only senses that the clock was lost and acts according to the input signal loss timeout.

To set the HDCP mode:

1. In the Navigation pane, click **Video & Audio Settings**. The Video & Audio Settings page appears (see [Figure 16](#)).
2. View the HDCP input status.
3. Enable or disable the HDCP mode.



You must set the HDCP preferences in at least the transmitter or receiver.

To set the audio switching delay:

1. In the Navigation pane, click **Video & Audio Settings**. The Video & Audio Settings page appears (see [Figure 16](#)).
2. Set the delay times for:
 - New signal
 - Signal loss
 - Cable unplug
3. Click **Set**.



Audio Priority switching is set via the DIP-switches, see [Section 6.17](#).

8.3 Setting Device Parameters

The Device Settings web page lets you view some of the device characteristics, (for example, model and firmware version) and also enables performing the following functions:

- Setting the device name.
- Changing the Ethernet settings.
- Loading and saving configurations for duplicating multiple device definitions for easy system configuration.
- Performing a factory reset.

To set the device name:

1. In the Navigation pane, click **Device Settings**. The Device Settings page appears:
2. Type the name in the Name text box and click **Set**.

To change the Ethernet settings manually:

1. In the Navigation pane, click **Device Settings**. The Device Settings page appears:

Device Settings

Unit name: KRAMER_ Set

Model: 691

Firmware version: 1.10.33085

Serial number: Set

Ethernet Settings

DHCP: ON **OFF**

IP address: 192 . 168 . 1 . 39

Mask address: 255 . 255 . 0 . 0

Gateway address: 192 . 168 . 0 . 1 Set

Mac address: 00-00-00-00-00-00 Set

UDP port: 50000 Set

TCP port: 5000 Set

All settings: Load... Save...

Factory reset

Figure 17: The Device Settings Page

2. Set DHCP to OFF

The DHCP OFF dialog box is displayed.

DHCP OFF ✕

Set a new IP address.
Following this you will lose your connection to the device.
To reconnect, enter the new IP address in your Web browser.

Custom IP: 10 . 15 . 154 . 54

Default IP: 192 . 168 . 1 . 39

Cancel Apply

Figure 18: Turning DHCP Off Dialog Box

3. Change any of the parameters (IP Address, Mask and/or Gateway address).
4. Click **Set**.

To automatically set Ethernet settings:

1. In the Navigation pane, click **Device Settings**. The Device Settings page appears (see [Figure 17](#)):
2. Set DHCP to **ON**.
3. The Communication Warning window appears.

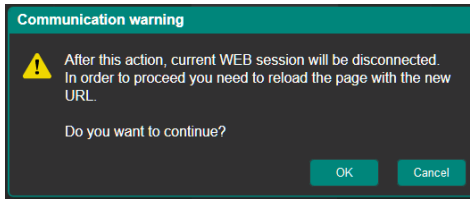

Figure 19: Turning DHCP On Warning

4. Click **OK**.
DHCP is turned on. The next time **691** is booted you must reload the Web pages using the IP address issued to the **691** by the DHCP server.

To turn DHCP off:

1. Set DHCP to **OFF**.
The DHCP OFF dialog box is displayed (see [Figure 18](#)).
2. To set a custom IP address, select Custom IP and enter the required address. To set the default IP address, select Default IP.
3. Click **Apply**.
The **691** IP address is changed and the Web page reloads automatically.
4. Click **Set**.



After changing the IP address, you need to reload the web page with the new IP address.

After changing the Subnet mask you need to turn the **691** power off and then on again.

To set the UDP/TCP ports:

1. In the Navigation pane, click **Device Settings**. The Device Settings page appears (see [Figure 17](#)).
2. Set the port number.
3. Click **Set**.

To save the current configuration to your PC:

1. In the Navigation pane, click **Device Settings**. The Device Settings page appears (see [Figure 17](#)).
2. Configure the device as required.
3. Click **Save**.
The Save File window opens.
4. Browse to the required location to which to save the file.
5. Click **OK**.
The current configuration is saved.



When using Chrome, the file is automatically saved in the Downloads folder.

To retrieve a saved configuration from your PC:

1. Connect your PC to the device to which you want to load the configuration.
2. Open the embedded Web pages (see [Section 8.1](#)).
3. In the Navigation pane, click **Device Settings**. The Device Settings page appears (see [Figure 17](#)).
4. Click **Load**.
The explorer window opens.
5. Browse to the required file.

6. Select the required file and click **Open**.

The device is configured according to the saved preset.

The following parameters are saved to the configuration file:

- From the **Video & Audio Settings** page (see [Figure 16](#)):
 - Video HDCP Mode.
 - Power off 5V upon video signal loss delay time.
 - Switching input upon new audio detected signal delay time.
 - Switching upon audio signal loss (5V remains on) delay time.
 - Switching input upon audio cable unplug delay time.
- From the **Device Settings** page (see [Figure 17](#)):
 - Unit Name.
 - UDP port settings
 - TCP port settings

To reset 691 to its factory default values:

1. In the Navigation pane, click **Device Settings**. The Device Settings page appears (see [Figure 17](#)).
2. Click **Factory reset**.
The confirmation message is displayed.
3. Click **OK** to continue or **Cancel** to exit the procedure.

8.4 Managing the EDID

The EDID Management page lets you read the EDID from the:

- Output
- Default EDID
- EDID data file

The selected EDID source can then be copied to the input.



Do not power up the display before locking the EDID.

To copy the EDID:

1. In the Navigation pane, click **EDID Management**. The EDID Management page appears:

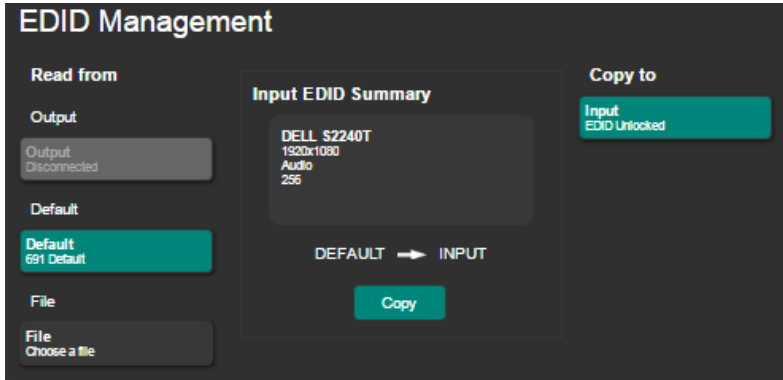

Figure 20: The EDID Management Page

2. Select one of the following EDID sources: the output, the **691** default, or click **Choose a file**.
3. Click **Copy** and wait for the device to complete the process. The “EDID was copied successfully” message is displayed and the EDID data is copied to the input.

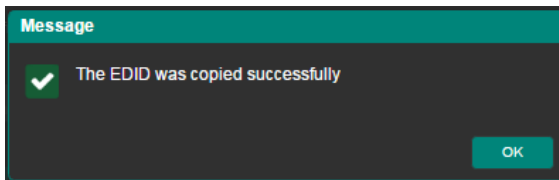

Figure 21: The EDID Message

4. Click **OK**.

The Input EDID Summary Information area displays the current selection of EDID source, video resolution, audio availability, and so on.

8.5 Authentication Page

The Authentication page lets you assign or change logon authentication details.



By-default User and Password are both Admin.

To set the authentication details:

1. In the Navigation pane, click **Authentication**. The Authentication page appears:

The screenshot shows a dark-themed web interface titled "Authentication". At the top, there is a toggle switch for "Activate Security" with "Enabled" selected. Below this, there is a "Change Password" section with three input fields labeled "Current", "New", and "Retype New". A green "Change" button is located at the bottom right of the form.

Figure 22: The Authentication Page

2. Set the authentication:
 - **Activate Security:** enable or disable the security settings. When enabled, the valid username (Admin, by default) and password (Admin, by default) must be provided to allow Web page access.
 - **Change Password:** enter the current password, enter the new password and then retype the new password and click **Change**.



If the Authentication page is left open for more than five minutes additional windows may open. After entering your logon credentials, close the other windows.

8.6 Viewing the About Page

The 691 About page lets you view the Web page version and Kramer Electronics Ltd details.



Figure 23: The About Page

9 Firmware Upgrade

You can upgrade the **691** via the Kramer **K-UPLOAD** tool.



The latest firmware version and the latest version of **K-UPLOAD** and installation instructions can be downloaded from Kramer Web site at www.kramerav.com/downloads/691.

10 Technical Specifications

Inputs	1 HDMI	On a female HDMI connector
	1 Stereo Analog Unbalanced Audio	2Vrms / 10kΩ on a 3.5mm mini jack
Outputs	1 Fiber Optic	On 2 LC connectors
Ports	1 IR	On a 3.5mm mini jack for IR link extension
	1 USB	On a female USB-B connector for USB link extension
	1 RS-232	On a 3-pin terminal block for serial link extension
	1 RS-232	On a 3-pin terminal block for device control
	1 100BaseT Ethernet	On an RJ-45 female connector for device control and LAN extension
Extension Line	Compliance	HDBaseT 2.0
	Optical Fiber	Multi-mode (MM) or single-mode (SM)
	Fiber Line	2 simplex strands
	Optical Module	10Gbps SFP+ IEEE 802.3ae compliant
Multi-mode Line	Compliance	G.651.1 OFNR fiber
	Nominal Peak Wavelength	850nm
	Max Data Rate	10.2Gbps
	Typical Optical Transmission Power	-2.5dBm
	Typical Optical Maximum Loss Budget	8.6dB
Max Reach over OM3 MM Fiber	3km (1.86 miles)	
Single-mode Line	Compliance	G.652D OFNR fiber
	Nominal Peak Wavelength	1310nm
	Max Data Rate	10.2Gbps
	Typical Optical Transmission Power	-2.5dBm
	Typical Optical Maximum Loss Budget	11.9dB
Max Reach over OS1 SM Fiber	33km (20.5 miles)	
Video	Max Bandwidth	10.2Gbps (3.4Gbps per graphic channel)
	Max Resolution	4K UHD @60Hz (4:2:0) 24bpp resolution
	Compliance	HDMI 2.0 and HDCP 1.4
Analog Audio	Max Vrms Level	1
	THD + NOISE	0.03% @1kHz at nominal level

Extended USB	Host Compliance	1.1 and 2.0
	Max Extended Line Rate Bandwidth	127Mbps (out of max 480 USB)
	Max Devices	7
	Max Hubs	2
	Max Ports per Hub	8
Extended Ethernet	Max Transmission Bandwidth	100Mbps
Extended RS-232	Baud Rate	300 to 115200
Control RS-232	Baud Rate	115200
Supported PC Web Browsers	Windows 7 and Higher	Internet Explorer (32/64 bit) version 10 Firefox version 30 Chrome version 35
	MAC	Chrome version 35 Firefox version 30 Safari version 7
	Minimum Browser Window Size	1024 x 768
Power	Consumption	12V DC, 1300mA
	Source	12V DC, 2A
Cooling	Convection Ventilation	
Environmental Conditions	Operating Temperature	0° to +40°C (32° to 104°F)
	Storage Temperature	-40° to +70°C (-40° to 158°F)
	Humidity	10% to 90%, RHL non-condensing
Regulatory Compliance	Safety	CE, UL
	Environmental	RoHs, WEEE
Enclosure	Size	Half 19" 1U
	Type	Aluminum
General	Net Dimensions (W, D, H)	21.46cm x 16.3 cm x 4.36cm (8.45" x 6.42" x 1.7")
	Shipping Dimensions (W, D, H)	35.1cm x 21.2cm x 7.2cm (13.82" x 8.35" x 2.8")
	Net Weight	0.95 kg (2.1lbs)
	Shipping Weight	1.45 kg (3.2lbs) approx.
Accessories	Included	Power supply
	Optional	For optimum range and performance use the recommended USB, Ethernet, serial and IR Kramer cables available at www.kramerav.com/product/691
Specifications are subject to change without notice at www.kramerav.com		

10.1 Default Communication Parameters

RS-232	
Baud Rate:	115,200
Data Bits:	8
Stop Bits:	1
Parity:	None
Command Format:	ASCII
Example (get device model name):	#model?<cr>
Ethernet	
IP Address:	192.168.1.39
Subnet mask:	255.255.0.0
Default gateway:	192.168.0.1
UDP Port:	50000
TCP Port:	5000
Full Factory Reset	
Rear panel button:	Press and hold to reset to factory default parameters
P3k command:	#factory<cr>
Embedded Web pages:	Select Device Settings page and click Factory reset

10.2 Default Parameters

Parameter	Value
Name	KRAMER_
Model	691
Audio delay input switching on new signal	0 seconds
Audio delay input switching on signal loss (leave 5V on)	5 seconds
Audio delay input switching on cable unplug	0 seconds
Video delay power off 5V on signal loss	15 minutes
HDCP	Follow output
Web Logon credentials	Name: Admin; Password: Admin

10.3 Default EDID

Monitor
 Model name..... 691
 Manufacturer..... KMR
 Plug and Play ID..... KMR1200
 Serial number..... n/a
 Manufacture date..... 2015, ISO week 255
 Filter driver..... None

 EDID revision..... 1.3
 Input signal type..... Digital
 Color bit depth..... Undefined
 Display type..... RGB color
 Screen size..... 520 x 320 mm (24.0 in)
 Power management..... Standby, Suspend, Active off/sleep
 Extension blocs..... 1 (CEA-EXT)

 DDC/CI..... n/a

Color characteristics

Default color space..... Non-sRGB
Display gamma..... 2.20
Red chromaticity..... Rx 0.674 - Ry 0.319
Green chromaticity..... Gx 0.188 - Gy 0.706
Blue chromaticity..... Bx 0.148 - By 0.064
White point (default).... Wx 0.313 - Wy 0.329
Additional descriptors... None

Timing characteristics

Horizontal scan range.... 30-83kHz
Vertical scan range..... 56-76Hz
Video bandwidth..... 170MHz
CVT standard..... Not supported
GTF standard..... Not supported
Additional descriptors... None
Preferred timing..... Yes
Native/preferred timing.. 1280x720p at 60Hz (16:10)
Modeline..... "1280x720" 74.250 1280 1390 1430 1650 720 725 730 750 +hsync +vsync

Standard timings supported

720 x 400p at 70Hz - IBM VGA
720 x 400p at 88Hz - IBM XGA2
640 x 480p at 60Hz - IBM VGA
640 x 480p at 67Hz - Apple Mac II
640 x 480p at 72Hz - VESA
640 x 480p at 75Hz - VESA
800 x 600p at 56Hz - VESA
800 x 600p at 60Hz - VESA
800 x 600p at 72Hz - VESA
800 x 600p at 75Hz - VESA
832 x 624p at 75Hz - Apple Mac II
1024 x 768i at 87Hz - IBM
1024 x 768p at 60Hz - VESA
1024 x 768p at 70Hz - VESA
1024 x 768p at 75Hz - VESA
1280 x 1024p at 75Hz - VESA
1152 x 870p at 75Hz - Apple Mac II
1280 x 1024p at 75Hz - VESA STD
1280 x 1024p at 85Hz - VESA STD
1600 x 1200p at 60Hz - VESA STD
1024 x 768p at 85Hz - VESA STD
800 x 600p at 85Hz - VESA STD
640 x 480p at 85Hz - VESA STD
1152 x 864p at 70Hz - VESA STD
1280 x 960p at 60Hz - VESA STD

EIA/CEA-861 Information

Revision number..... 3
IT underscan..... Supported
Basic audio..... Supported
YCbCr 4:4:4..... Supported
YCbCr 4:2:2..... Supported
Native formats..... 1
Detailed timing #1..... 1920x1080p at 60Hz (16:10)
Modeline..... "1920x1080" 148.500 1920 2008 2052 2200 1080 1084 1089 1125 +hsync +vsync
Detailed timing #2..... 1920x1080i at 60Hz (16:10)
Modeline..... "1920x1080" 74.250 1920 2008 2052 2200 1080 1084 1094 1124 interlace +hsync +vsync
Detailed timing #3..... 1280x720p at 60Hz (16:10)
Modeline..... "1280x720" 74.250 1280 1390 1430 1650 720 725 730 750 +hsync +vsync
Detailed timing #4..... 720x480p at 60Hz (16:10)
Modeline..... "720x480" 27.000 720 736 798 858 480 489 495 525 -hsync -vsync

CE audio data (formats supported)

PCM 2-channel, 16/20/24 bit depths at 32/44/48 kHz

CE video identifiers (VICs) - timing/formats supported

1920 x 1080p at 60Hz - HDTV (16:9, 1:1)
1920 x 1080i at 60Hz - HDTV (16:9, 1:1)
1280 x 720p at 60Hz - HDTV (16:9, 1:1) [Native]

720 x 480p at 60Hz - EDTV (16:9, 32:27)
720 x 480p at 60Hz - EDTV (4:3, 8:9)
720 x 480i at 60Hz - Doublescan (16:9, 32:27)
720 x 576i at 50Hz - Doublescan (16:9, 64:45)
640 x 480p at 60Hz - Default (4:3, 1:1)
NB: NTSC refresh rate = (Hz*1000)/1001

CE vendor specific data (VSDB)
IEEE registration number. 0x00C03
CEC physical address..... 1.0.0.0
Maximum TMDS clock..... 165MHz

CE speaker allocation data
Channel configuration..... 2.0
Front left/right..... Yes
Front LFE..... No
Front center..... No
Rear left/right..... No
Rear center..... No
Front left/right center.. No
Rear left/right center... No
Rear LFE..... No

Report information
Date generated..... 23/07/2015
Software revision..... 2.60.0.972
Data source..... File
Operating system..... 6.1.7601.2.Service Pack 1

Raw data
00,FF,FF,FF,FF,FF,FF,00,2D,B2,00,12,00,00,00,00,FF,19,01,03,80,34,20,78,EA,B3,25,AC,51,30,B4,26,
10,50,54,FF,FF,80,81,8F,81,99,A9,40,61,59,45,59,31,59,71,4A,81,40,01,1D,00,72,51,D0,1E,20,6E,28,
55,00,07,44,21,00,00,1E,00,00,00,FD,00,38,4C,1E,53,11,00,0A,20,20,20,20,20,20,00,00,00,FC,00,54,
50,2D,35,39,30,52,58,52,20,20,20,20,00,00,00,00,00,00,00,00,00,00,00,00,00,00,00,00,01,28,
02,03,1B,F1,23,09,07,07,48,10,05,84,03,02,07,16,01,65,03,0C,00,10,00,83,01,00,00,02,3A,80,18,71,
38,2D,40,58,2C,45,00,07,44,21,00,00,1E,01,1D,80,18,71,1C,16,20,58,2C,25,00,07,44,21,00,00,9E,01,
1D,00,72,51,D0,1E,20,6E,28,55,00,07,44,21,00,00,1E,8C,0A,D0,8A,20,E0,2D,10,10,3E,96,00,07,44,21,
00,00,18,00,47

11 Protocol 3000

The **691** HDBT 2.0 Optical Transmitter can be operated using the Kramer Protocol 3000 serial commands. The command framing varies according to how you interface with the **691**. For example, a basic video input switching command that routes a layer 1 video signal to HDMI out 1 from HDMI input 2 (ROUTE 1, 1, 2), is entered as follows:

- Terminal communication software, such as Hercules:

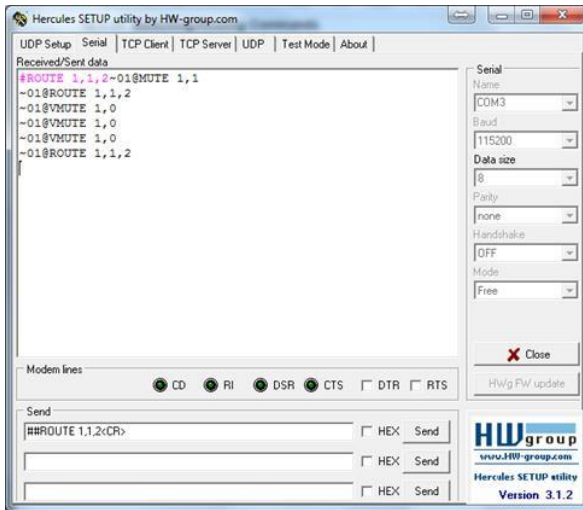

The framing of the command varies according to the terminal communication software.

- K-Touch Builder (Kramer software):

'Device Code (17)' PROPERTIES	
name	Device Code (17)
data	#ROUTE 1,1,2x0D

- K-Config (Kramer configuration software):

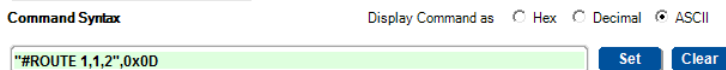

All the examples provided in this section are based on using the K-Config software.

You can enter commands directly using terminal communication software (e.g., Hercules) by connecting a PC to the serial or Ethernet port on the **691**. To enter `CR` press the Enter key (`LF` is also sent but is ignored by the command parser).

Commands sent from various non-Kramer controllers (e.g., Crestron) may require special coding for some characters (such as, /x##). For more information, refer to your controller's documentation.

For more information about:

- Using Protocol 3000 commands, see [Section 11.1](#)
- General syntax used for Protocol 3000 commands, see [Section 11.2](#)
- Protocol 3000 commands available for the **691**, see [Section 11.3](#)

11.1 Understanding Protocol 3000

Protocol 3000 commands are structured according to the following:

- **Command** – A sequence of ASCII letters (A-Z, a-z and -). A command and its parameters must be separated by at least one space.
- **Parameters** – A sequence of alphanumeric ASCII characters (0-9, A-Z, a-z and some special characters for specific commands). Parameters are separated by commas.
- **Message string** – Every command entered as part of a message string begins with a message starting character and ends with a message closing character.



A string can contain more than one command. Commands are separated by a pipe (|) character.

The maximum string length is 64 characters.

- **Message starting character:**
 - # – For host command/query
 - ~ – For device response
- **Device address** – K-NET Device ID followed by @ (optional, K-NET only)
- **Query sign** – ? follows some commands to define a query request
- **Message closing character:**
 - CR – Carriage return for host messages (ASCII 13)
 - CR LF – Carriage return for device messages (ASCII 13) and line-feed (ASCII 10)
- **Command chain separator character** – Multiple commands can be chained in the same string. Each command is delimited by a pipe character (|). When chaining commands, enter the message starting character and the message closing character only at the beginning and end of the string.



Spaces between parameters or command terms are ignored. Commands in the string do not execute until the closing character is entered. A separate response is sent for every command in the chain.

11.2 Kramer Protocol 3000 Syntax

The Kramer Protocol 3000 syntax uses the following delimiters:

- **CR** = Carriage return (ASCII 13 = 0x0D)
- **LF** = Line feed (ASCII 10 = 0x0A)
- **SP** = Space (ASCII 32 = 0x20)

Some commands have short name syntax in addition to long name syntax to enable faster typing. The response is always in long syntax.

The Protocol 3000 syntax is in the following format:

- **Host Message Format:**

Start	Address (optional)	Body	Delimiter
#	<i>Device_id@</i>	Message	CR

- **Simple Command** – Command string with only one command without addressing:

Start	Body	Delimiter
#	Command SP <i>Parameter_1,Parameter_2,...</i>	CR

- **Command String** – Formal syntax with command concatenation and addressing:

Start	Address	Body	Delimiter
#	<i>Device_id@</i>	Command_1 <i>Parameter1_1,Parameter1_2,...</i> Command_2 <i>Parameter2_1,Parameter2_2,...</i> Command_3 <i>Parameter3_1,Parameter3_2,...</i> ...	CR

- **Device Message Format:**

Start	Address (optional)	Body	Delimiter
~	<i>Device_id@</i>	Message	CR LF

- **Device Long Response** – Echoing command:

Start	Address (optional)	Body	Delimiter
~	<i>Device_id@</i>	Command SP [<i>Param1 ,Param2 ...</i>] result	CR LF

11.3 Protocol 3000 Commands

This section includes the following commands:

- System Commands (see [Section 11.3.1](#))
- Authentication Commands (see [Section 11.3.2](#))
- Audio Commands (see [Section 11.3.3](#))
- Communication Commands (see [Section 11.3.4](#))
- EDID Handling Commands (see [Section 11.3.5](#))
- Administrator Commands (see [Section 11.3.6](#))

11.3.1 System Commands

Command	Description
#	Protocol handshaking (system mandatory)
BUILD-DATE	Get device build date (system mandatory)
FACTORY	Reset to factory default configuration
HELP	Get command list (system mandatory)
MODEL	Get device model (system mandatory)
PROT-VER	Get device protocol version (system mandatory)
RESET	Reset device (system mandatory)
SN	Get device serial number (system mandatory)
VERSION	Get device firmware version (system mandatory)
AV-SW-MODE	Get auto switch mode (system)
AV-SW-TIMEOUT	Set/get auto switching timeout (system)
DISPLAY	Get output HPD status (system)
DPSW-STATUS	Get the DIP-switch status (system)
HDCP-MOD	Set/get HDCP mode (system)
HDCP-STAT	Get HDCP signal status (system)
NAME	Set/get machine (DNS) name (system – Ethernet)
NAME-RST	Reset machine (DNS) name to factory default (system – Ethernet)
PRIORITY	Get priority for all channels (system)
SIGNAL	Get input signal lock status (system)

11.3.1.1

Functions		Permission	Transparency
Set:	#	End User	Public
Get:	-	-	-
Description		Syntax	
Set:	Protocol handshaking	#	CR
Get:	-	-	-
Response			
~nn@SPokCR LF			
Notes			
Validates the Protocol 3000 connection and gets the machine number Step-in master products use this command to identify the availability of a device			
K-Config Example			
"#", 0x0D			

11.3.1.2 BUILD-DATE

Functions		Permission	Transparency
Set:	-	-	-
Get:	BUILD-DATE?	End User	Public
Description		Syntax	
Set:	-	-	-
Get:	Get device build date	#BUILD-DATE?	CR
Response			
~nn@BUILD-DATESPdateSPtimeCR LF			
Parameters			
date – Format: YYYY/MM/DD where YYYY = Year, MM = Month, DD = Day time – Format: hh:mm:ss where hh = hours, mm = minutes, ss = seconds			
K-Config Example			
"#BUILD-DATE?", 0x0D			

11.3.1.3 FACTORY

Functions		Permission	Transparency
Set:	FACTORY	End User	Public
Get:	-	-	-
Description		Syntax	
Set:	Reset device to factory default configuration	#FACTORYCR	
Get:	-	-	
Response			
~nn@FACTORYSEOKCR LF			
Notes			
This command deletes all user data from the device. The deletion can take some time. Your device may require powering off and powering on for the changes to take effect.			
K-Config Example			
"#FACTORY", 0x0D			

11.3.1.4 HELP

Functions		Permission	Transparency
Set:	-	-	-
Get:	HELP	End User	Public
Description		Syntax	
Set:	-	-	
Get:	Get command list or help for specific command	1. #HELPCR 2. #HELPSECOMMAND_NAMECR	
Response			
1. Multi-line: ~nn@Device available protocol 3000 commands:CR LFcommand,SE command...CR LF 2. Multi-line: ~nn@HELPSEcommand:CR LFdescriptionCR LFUSAGE:usageCR LF			
Parameters			
COMMAND_NAME – name of a specific command			
Notes			
To get help for a specific command use: HELPSECOMMAND_NAMECR LF			
K-Config Example			
"#HELP", 0x0D			

11.3.1.5 MODEL

Functions		Permission	Transparency
Set:	-	-	-
Get:	MODEL?	End User	Public
Description		Syntax	
Set:	-	-	
Get:	Get device model	# MODEL? <code>CR</code>	
Response			
~ <code>nn</code> @ MODEL? <code>SE</code> model_name <code>CR LF</code>			
Parameters			
model_name – String of up to 19 printable ASCII chars			
Notes			
This command identifies equipment connected to Step-in master products and notifies of identity changes to the connected equipment. The Matrix saves this data in memory to answer REMOTE-INFO requests			
K-Config Example			
"#MODEL?", 0x0D			

11.3.1.6 PROT-VER

Functions		Permission	Transparency
Set:	-	-	-
Get:	PROT-VER?	End User	Public
Description		Syntax	
Set:	-	-	
Get:	Get device protocol version	# PROT-VER? <code>CR</code>	
Response			
~ <code>nn</code> @ PROT-VER? <code>SE</code> 3000:version <code>CR LF</code>			
Parameters			
version - XX.XX where X is a decimal digit			
K-Config Example			
"#PROT-VER?", 0x0D			

11.3.1.7 RESET

Functions		Permission	Transparency
Set:	RESET	Administrator	Public
Get:	-	-	-
Description		Syntax	
Set:	Reset device	# RESET <code>[CR]</code>	
Get:	-	-	
Response			
~ <code>[nn]</code> @ RESET <code>[S]</code> OK <code>[CR LF]</code>			
Notes			
To avoid locking the port due to a USB bug in Windows, disconnect USB connections immediately after running this command. If the port was locked, disconnect and reconnect the cable to reopen the port.			
K-Config Example			
`"#RESET", 0x0D`			

11.3.1.8 SN

Functions		Permission	Transparency
Set:	-	-	-
Get:	SN?	End User	Public
Description		Syntax	
Set:	-	-	
Get:	Get device serial number	# SN? <code>[CR]</code>	
Response			
~ <code>[nn]</code> @ SN <code>[S]</code> serial_number <code>[CR LF]</code>			
Parameters			
serial_number – 11 decimal digits, factory assigned			
Notes			
This device has a 14 digit serial number, only the last 11 digits are displayed			
K-Config Example			
`"#SN?", 0x0D`			

11.3.1.9 VERSION

Functions		Permission	Transparency
Set:	-	-	-
Get:	VERSION?	End User	Public
Description		Syntax	
Set:	-	-	
Get:	Get firmware version number	# VERSION? <code>CR</code>	
Response			
~ <code>nn</code> @ VERSION <code>SE</code> firmware_version <code>CR LF</code>			
Parameters			
firmware_version – XX.XX.XXXX where the digit groups are: major.minor.build version			
K-Config Example			
"##VERSION?",0x0D			

11.3.1.10 AV-SW-MODE

Functions		Permission	Transparency
Set:			
Get:	AV-SW-MODE?	End user	Public
Description		Syntax	
Set:			
Get:	Get input auto switch mode (per output)	# AV-SW-MODE? <code>SE</code> layer,output_id <code>CR</code>	
Response			
~ <code>nn</code> @ AV-SW-MODE <code>SE</code> layer,output_id,mode <code>CR LF</code>			
Parameters			
layer – 2 (audio) output_id – for audio layer: 1 (Audio Out) mode – 0 (manual), 1 (priority switch)			
K-Config Example			
Get the input audio switch mode for HDMI Out: "##AV-SW-MODE? 2,1",0x0D			

11.3.1.11 AV-SW-TIMEOUT

Functions		Permission	Transparency
Set:	AV-SW-TIMEOUT	End User	Public
Get:	AV-SW-TIMEOUT?	End User	Public
Description		Syntax	
Set:	Set auto switching timeout	# AV-SW-TIMEOUT [SP]action,time_out[CR]	
Get:	Get auto switching timeout	# AV-SW-TIMEOUT? [SP]action[CR]	
Response			
~nn@ AV-SW-TIMEOUT [SP]action,time_out[CR]			
Parameters			
action – event that triggers the auto switching timeout: 2 (audio signal lost) 3 (Audio signal detected) 4 (disable 5V on video output if no input signal detected) 6 (audio cable unplugged) timeout – timeout in seconds: 0-60000			
Notes			
The timeout must not exceed 60000 seconds.			
K-Config Example			
Set the auto switching timeout to 5 seconds in the event of no input signal detected: “#AV-SW-TIMEOUT 4,5”,0x0D			

11.3.1.12 DISPLAY

Functions		Permission	Transparency
Set:	-	-	-
Get:	DISPLAY?	End User	Public
Description		Syntax	
Set:	-	-	
Get:	Get output HPD status	# DISPLAY? [SP]out_id[CR]	
Response			
~nn@ DISPLAY [SP]out_id,status[CR LF]			
Parameters			
out_id – 1 (Out)= status – HPD status according to signal validation : 0 (Off), 1 (On), 2 (On and all parameters are stable and valid)			
Response Triggers			
A response is sent to the com port from which the Get was received, after command execution and: After every change in output HPD status from On to Off (0) After every change in output HPD status from Off to On (1) After every change in output HPD status form Off to On and all parameters (new EDID, etc.) are stable and valid (2)			
K-Config Example			
Get the output HPD status of HDMI Out: “#DISPLAY? 1”,0x0D			

11.3.1.13 HDCP-MOD

Functions		Permission	Transparency
Set:	HDCP-MOD	Administrator	Public
Get:	HDCP-MOD?	End User	Public
Description		Syntax	
Set:	Set HDCP mode	#HDCP-MOD[S]inp_id,mode[CR]	
Get:	Get HDCP mode	#HDCP-MOD?[S]inp_id[CR]	
Response			
Set / Get: ~[nn]@HDCP-MOD[S]inp_id,mode[CR LF]			
Parameters			
inp_id – input number: 1 (HDMI In) mode – HDCP mode: 0 (HDCP Off), Mirror output: 3 (MAC mode)			
Response Triggers			
A response is sent to the com port from which the set (before execution) / get command was received A response is sent to all com ports after command execution if HDCP-MOD was set by any other external control device (device button, device menu or other) or if the HDCP mode changed			
Notes			
Set HDCP working mode on the device input: HDCP not supported - HDCP Off HDCP support changes following detected sink - MIRROR OUTPUT			
K-Config Example			
Disable HDCP mode on HDMI In: `#HDCP-MOD 1, 0", 0x0D			

11.3.1.14 HDCP-STAT

Functions		Permission	Transparency
Set:	-	-	-
Get:	HDCP-STAT?	End User	Public
Description		Syntax	
Set:	-	-	
Get:	Get HDCP signal status	# HDCP-STAT? [SP] stage,stage_id [CR]	
Response			
~ [nn] @ [hn] HDCP-STAT? [SP] stage,stage_id,status [CR LF]			
Parameters			
stage – 0 (input), 1 (output) stage_id – for input stage: 1 (HDMI In), for output stage: 1 (HDMI Out) status – signal encryption status: 0 (On), 1 (Off)			
Response Triggers			
A response is sent to the com port from which the Get command was received			
Notes			
Output stage (1) – get the HDCP signal status of the sink device connected to HDMI Out Input stage (0) – get the HDCP signal status of the source device connected to the specified input			
K-Config Example			
Get the HDCP input signal status of the source device connected to HDMI In: "#HDCP-STAT? 0,1",0x0D			

11.3.1.15 NAME

Functions		Permission	Transparency
Set:	NAME	Administrator	Public
Get:	NAME?	End User	Public
Description		Syntax	
Set:	Set machine (DNS) name	# NAME [SP] machine_name [CR]	
Get:	Get machine (DNS) name	# NAME? [CR]	
Response			
Set: ~ [nn] @ [NAME] [SP] machine_name [CR LF] Get: ~ [nn] @ [NAME? [SP] machine_name [CR LF]			
Parameters			
machine_name – String of up to 14 alpha-numeric characters (can include hyphens but not at the beginning or end)			
Notes			
The machine name is not the same as the model name. The machine name is used to identify a specific machine or a network in use (with DNS feature on).			
K-Config Example			
Set the DNS name of the device to "room-442": "#NAME room-442",0x0D			

11.3.1.16 NAME-RST

Functions		Permission	Transparency
Set:	NAME-RST	Administrator	Public
Get:	-	-	-
Description		Syntax	
Set:	Reset machine (DNS) name to factory default	# NAME-RST <code>CR</code>	
Get:	-	-	
Response			
~ <code>nn@NAME-RSTSEOKCR LF</code>			
Notes			
Factory default of machine (DNS) name is "KRAMER_"			
K-Config Example			
Reset the DNS name of the device to the factory default: "#NAME-RST", 0x0D			

11.3.1.17 PRIORITY

Functions		Permission	Transparency
Set:	-		
Get:	PRIORITY?	Administrator	Public
Description		Syntax	
Set:			
Get:	Get input priority	# PRIORITY? layer <code>CR</code>	
Response			
~ <code>nn@PRIORITYSElayer, PRIORITY1, PRIORITY2CR LF</code>			
Parameters			
layer – 2 (audio): PRIORITY1 - priority of embedded audio: 1 (highest priority), 2 (second priority) PRIORITY2 - priority of Audio In: 1 (highest priority), 2 (second priority)			
Notes			
The number of PRIORITY parameters differs according to the selected layer 1 is the highest priority			
K-Config Example			
Set the embedded audio to highest priority and the analog audio to second priority: "#PRIORITY 2, 1, 2", 0x0D			

11.3.1.18 SIGNAL

Functions		Permission	Transparency
Set:	-	-	-
Get	SIGNAL?	End User	Public
Description		Syntax	
Set:	-	-	
Get:	Get input signal lock status	# SIGNAL? SPinp_idCR	
Response			
~nn@ SIGNAL SPinp_id,statusCR LF			
Parameters			
inp_id – input number: 1 (HDMI In) status – lock status according to signal validation: 0 (Off), 1 (On)			
Response Triggers			
After execution, a response is sent to the com port from which the Get was received A response is sent after every change in input signal status from On to Off or from Off to On			
K-Config Example			
Get the input signal lock status of HDMI In: "#SIGNAL? 1",0x0D			

11.3.2 Authentication Commands

Command	Description
LOGIN	Set/get protocol permission
LOGOUT	Cancel current permission level
PASS	Set/get password for login level
SECUR	Set/get current security state

11.3.2.1 LOGIN

Functions		Permission	Transparency
Set:	LOGIN	Not Secure	Public
Get:	LOGIN?	Not Secure	Public
Description		Syntax	
Set:	Set protocol permission	# LOGIN [SF]login_level,password[CR]	
Get:	Get current protocol permission level	# LOGIN? [CR]	
Response			
Set: ~nn@ LOGIN [SF]login_level,password[SF ok] CR LF			
or			
~nn@ LOGIN [SF ERR[SF 004] CR LF (if bad password entered)			
Get: ~nn@ LOGIN [SF]login_level CR LF			
Parameters			
login_level – level of permissions required: User, Admin			
password – predefined password (by PASS command). Default password is an empty string			
Notes			
When the permission system is enabled, LOGIN enables running commands with the User or Administrator permission level			
When set, login must be performed upon each connection			
The permission system works only if security is enabled with the SECUR command. It is not mandatory to enable the permission system in order to use the device			
K-Config Example			
Set the protocol permission level to Admin (when the password defined in the PASS command is 33333): "#LOGIN Admin,33333",0x0D			

11.3.2.2 LOGOUT

Functions		Permission	Transparency
Set:	LOGOUT	Not Secure	Public
Get:	-	-	-
Description		Syntax	
Set:	Cancel current permission level	# LOGOUT <u>CR</u>	
Get:	-	-	
Response			
~ <u>nn</u> @ LOGOUT <u>SP</u> ok <u>CR LF</u>			
Notes			
Logs out from User or Administrator permission levels			
K-Config Example			
"#LOGOUT",0x0D			

11.3.2.3 PASS

Functions		Permission	Transparency
Set:	PASS	Administrator	Public
Get:	PASS?	Administrator	Public
Description		Syntax	
Set:	Set password for login level	# PASS <u>SP</u> login_level,password <u>CR</u>	
Get:	Get password for login level	# PASS? <u>SP</u> login_level <u>CR</u>	
Response			
~ <u>nn</u> @ PASS <u>SP</u> login_level,password <u>CR LF</u>			
Parameters			
login_level – level of login to set: User, Admin password – password for the login_level. Up to 15 printable ASCII chars.			
Notes			
The default password is an empty string			
K-Config Example			
Set the password for the Admin protocol permission level to 33333: "#PASS Admin,33333",0x0D			

11.3.2.4 SECUR

Functions		Permission	Transparency
Set:	SECUR	Administrator	Public
Get:	SECUR?	Not Secure	Public
Description		Syntax	
Set:	Start/stop security	# SECUR [SF]security_mode[CR]	
Get:	Get current security state	# SECUR? [CR]	
Response			
~[nn]@ SECUR [SF]security_mode[CR] LF			
Parameters			
security_mode – 1 (On / enable security), 0 (Off / disable security)			
Notes			
The permission system works only if security is enabled with the SECUR command			
K-Config Example			
Enable the permission system: "#SECUR 1",0x0D			

11.3.3 Audio Commands

Command	Description
AUD-EMB	Get audio in video embedding status
AUD-SIGNAL?	Get audio input signal status

11.3.3.1 AUD-EMB

Functions		Permission	Transparency
Set:			
Get:	AUD-EMB?	End User	Public
Description		Syntax	
Set:			
Get:	Get audio in video embedding status	# AUD-EMB? [SF]in,out[CR]	
Response			
~[nn]@ AUD-EMB [SF]in,out,status[CR] LF			
Parameters			
in – embedded audio input number: 1 (Audio In) out – video output number in which audio is embedded: 1 (HDMI Out) status – embedded status: 1 (On), 0 (Off)			
Response Triggers			
A response is sent to the com port from which the get command was received After execution, a response is sent to all com ports if AUD-EMB was set by any other external control device (button press, device menu and similar)			
K-Config Example			
"#AUD-EMB? 1,1",0x0D			

11.3.3.2 AUD-SIGNAL

Functions		Permission	Transparency
Set:	-	-	-
Get	AUD-SIGNAL?	End User	Public
Description		Syntax	
Set:	-	-	
Get:	Get audio input signal status	# AUD-SIGNAL? <code>[SP]</code> inp_id <code>[CR]</code>	
Response			
~ <code>[nr]</code> @ AUD-SIGNAL <code>[SP]</code> inp_id,status <code>[CR LF]</code>			
Parameters			
inp_id – audio input number: 1 (Audio In) status – 0 (Off / no signal), 1 (On / signal present)			
Response Triggers			
After execution, a response is sent to the com port from which the get command was received A response is sent to all com ports if the audio status was changed on any input			
K-Config Example			
`#AUD-SIGNAL? 1",0x0D			

11.3.4 Communication Commands

Command	Description
ETH-PORT	Set/get Ethernet port protocol
NET-DHCP	Set/get DHCP mode
NET-GATE	Set/get gateway IP
NET-IP	Set/get IP address
NET-MAC	Get MAC address
NET-MASK	Set/get subnet mask

11.3.4.1 ETH-PORT

Functions		Permission	Transparency
Set:	ETH-PORT	Administrator	Public
Get:	ETH-PORT?	End User	Public
Description		Syntax	
Set:	Set Ethernet port protocol	# ETH-PORT [SP]portType,ETHPort[CR]	
Get:	Get Ethernet port protocol	# ETH-PORT? [SP]portType[CR]	
Response			
~nn@ ETH-PORT [SP]portType,ETHPort[CR LF]			
Parameters			
portType – string of 3 letters indicating the port type: TCP, UDP ETHPort – TCP / UDP port number: 0-65565			
Notes			
If the port number you enter is already in use, an error is returned The port number must be within the following range: 0-(2^16-1)			
K-Config Example			
Set the Ethernet port protocol for TCP to port 12457: "#ETH-PORT TCP,12457",0x0D			

11.3.4.2 NET-DHCP

Functions		Permission	Transparency
Set:	NET-DHCP	Administrator	Public
Get:	NET-DHCP?	End User	Public
Description		Syntax	
Set:	Set DHCP mode	# NET-DHCP SP mode CR	
Get:	Get DHCP mode	# NET-DHCP? CR	
Response			
~ nn @ NET-DHCP SP mode CR LF			
Parameters			
mode – 0 (do not use DHCP. Use the IP address set by the factory or the NET-IP command), 1 (try to use DHCP. If unavailable, use the IP address set by the factory or the NET-IP command)			
Notes			
Connecting Ethernet to devices with DHCP may take more time in some networks To connect with a randomly assigned IP by DHCP, specify the device DNS name (if available) using the NAME command. You can also get an assigned IP by direct connection to USB or RS-232 protocol port if available Consult your network administrator for correct settings			
K-Config Example			
Enable DHCP mode, if available: "#NET-DHCP 1",0x0D			

11.3.4.3 NET-GATE

Functions		Permission	Transparency
Set:	NET-GATE	Administrator	Public
Get:	NET-GATE?	End User	Public
Description		Syntax	
Set:	Set gateway IP	# NET-GATE SP ip_address CR	
Get:	Get gateway IP	# NET-GATE? CR	
Response			
~ nn @ NET-GATE SP ip_address CR LF			
Parameters			
ip_address – gateway IP address, in the following format: xxx.xxx.xxx.xxx			
Notes			
A network gateway connects the device via another network, possibly over the Internet. Be careful of security problems. Consult your network administrator for correct settings.			
K-Config Example			
Set the gateway IP address to 192.168.0.1: "#NET-GATE 192.168.000.001",0x0D			

11.3.4.4 NET-IP

Functions		Permission	Transparency
Set:	NET-IP	Administrator	Public
Get:	NET-IP?	End User	Public
Description		Syntax	
Set:	Set IP address	# NET-IP SF ip_address CR	
Get:	Get IP address	# NET-IP? CR	
Response			
~nn@ NET-IP SF ip_address CR LF			
Parameters			
ip_address – IP address, in the following format: xxx.xxx.xxx.xxx			
Notes			
Consult your network administrator for correct settings			
K-Config Example			
Set the IP address to 192.168.1.39: "#NET-IP 192.168.001.039",0x0D			

11.3.4.5 NET-MAC

Functions		Permission	Transparency
Set:	-	-	-
Get:	NET-MAC?	End User	Public
Description		Syntax	
Set:	-	-	
Get:	Get MAC address	# NET-MAC? CR	
Response			
~nn@ NET-MAC SF mac_address CR LF			
Parameters			
mac_address – unique MAC address. Format: XX-XX-XX-XX-XX-XX where X is hex digit			
K-Config Example			
"#NET-MAC?",0x0D			

11.3.4.6 NET-MASK

Functions		Permission	Transparency
Set:	NET-MASK	Administrator	Public
Get:	NET-MASK?	End User	Public
Description		Syntax	
Set:	Set subnet mask	# NET-MASK <code>SE</code> net_mask <code>CR</code>	
Get:	Get subnet mask	# NET-MASK? <code>CR</code>	
Response			
~ <code>nn</code> @ NET-MASK <code>SE</code> net_mask <code>CR LF</code>			
Parameters			
net_mask – format: xxx.xxx.xxx.xxx			
Response Triggers			
The subnet mask limits the Ethernet connection within the local network Consult your network administrator for correct settings			
K-Config Example			
Set the subnet mask to 255.255.0.0: `#NET-MASK 255.255.000.000`,0x0D			

11.3.5 EDID Handling Commands

Additional EDID data functions can be performed via the **691** web pages or a compatible EDID management application, such as Kramer EDID Designer (see www.kramerav.com/product/EDID%20Designer).

Command	Description
CPEDID	Copy EDID data from the output to the input EEPROM
LOCK-EDID	Lock last read EDID

11.3.5.1 CPEDID

Functions		Permission	Transparency
Set:	CPEDID	End User	Public
Get:	-	-	-
Description		Syntax	
Set:	Copy EDID data from the output to the input EEPROM	#CPEDID ^{SF} src_type,src_id,dst_type,dest_bitmap ^{CR}	
Get:	-	-	
Response			
~nn@CPEDID ^{SF} src_type,src_id,dst_type,dest_bitmap ^{CR LF}			
Parameters			
src_type – EDID source type (usually output): 0 (input), 1 (output), 2 (default EDID)			
src_id – for input source: 1(HDMI In); for output source: 1 (HDMI Out), for default EDID source: 0 (default EDID)			
dst_type – EDID destination type (usually input): 0 (input), 1 (output), 2 (default EDID)			
dest_bitmap – bitmap representing destination IDs. Format: XXXX...X, where X is hex digit. The binary form of every hex digit represents corresponding destinations. Setting '1' indicates that EDID data is copied to this destination. Setting '0' indicates that EDID data is not copied to this destination.			
Response Triggers			
Response is sent to the com port from which the Set was received (before execution)			
Notes			
Destination bitmap size depends on device properties (for 64 inputs it is a 64-bit word)			
Example: bitmap 0x0013 means inputs 1, 2 and 5 are loaded with the new EDID.			
In this device, if the destination type is input (0), the bitmap size is 1 bit, bitmap 0x1 means input 1 is loaded with the new EDID.			
K-Config Example			
Copy the EDID data from the HDMI Out output (EDID source) to the HDMI In 1 input: `#CPEDID 1,1,0,0x1",0x0D`			

11.3.5.2 LOCK-EDID

Functions		Permission	Transparency
Set:	LOCK-EDID	End User	End User
Get:	LOCK-EDID?	End User	End User
Description		Syntax	
Set:	Lock last read EDID	#LOCK-EDID <input type="text"/> input_id, lock_mode <input type="text"/> CR	
Get:	Get EDID lock state	#LOCK-EDID? <input type="text"/> input_id <input type="text"/> CR	
Response			
~nn@LOCK-EDID <input type="text"/> input_id, lock_mode <input type="text"/> CR LF			
Parameters			
input_id – HDMI 1 (In) lock_mode – 0 (Off: unlocks EDID), 1 (On: locks EDID)			
K-Config Example			
Lock the last read EDID from the HDMI In input: "#LOCK-EDID 1,1",0x0D			

11.3.6 Administrator Commands

Command	Description
DIR	List files in device
FS-FREE	Get file system free space
GET	Get file

11.3.6.1 DIR

Functions		Permission	Transparency
Set:	-	Administrator	Public
Get:	DIR		
Description		Syntax	
Set:			
Get:	List files in device	#DIR <input type="text"/> CR	
Response			
Multi Line: ~nn@DIR <input type="text"/> CR LF file_name <input type="text"/> TAB file_size <input type="text"/> bytes, <input type="text"/> ID: <input type="text"/> file_id <input type="text"/> CR LF <input type="text"/> free_size <input type="text"/> bytes <input type="text"/> CR LF			
Parameters			
file_name – name of file file_size – file size in bytes. A file can take more space on device memory file_id – internal ID for file in file system free_size – free space in bytes in device file system			
K-Config Example			
"#DIR",0x0D			

11.3.6.2 FS-FREE

Functions		Permission	Transparency
Set:	-		
Get:	FS-free?	Administrator	Public
Description		Syntax	
Set:			
Get:	Get file system free space	#FS-FREE? CR	
Response			
Multi Line: ~ nn @FS_FREE SP free_size CR LF			
Parameters			
free_size – free size in device file system in bytes			
K-Config Example			
"#FS-FREE?", 0x0D			

11.3.6.3 GET

Functions		Permission	Transparency
Set:	-		
Get:	GET	Administrator	Public
Description		Syntax	
Set:			
Get:	Get file	#GET SP file_name CR	
Response			
Multi-line: ~ nn @GET SP file_name, file_size SP READY CR LF contents ~ nn @GET SP file_name SP OK CR LF			
Parameters			
file_name – name of file to get contents contents – byte stream of file contents file_size – size of file (device sends it in response to give user a chance to get ready)			
K-Config Example			
"#GET", 0x0D			

The warranty obligations of Kramer Electronics Inc. ("Kramer Electronics") for this product are limited to the terms set forth below:

What is Covered

This limited warranty covers defects in materials and workmanship in this product.

What is Not Covered

This limited warranty does not cover any damage, deterioration or malfunction resulting from any alteration, modification, improper or unreasonable use or maintenance, misuse, abuse, accident, neglect, exposure to excess moisture, fire, improper packing and shipping (such claims must be presented to the carrier), lightning, power surges, or other acts of nature. This limited warranty does not cover any damage, deterioration or malfunction resulting from the installation or removal of this product from any installation, any unauthorized tampering with this product, any repairs attempted by anyone unauthorized by Kramer Electronics to make such repairs, or any other cause which does not relate directly to a defect in materials and/or workmanship of this product. This limited warranty does not cover cartons, equipment enclosures, cables or accessories used in conjunction with this product.

Without limiting any other exclusion herein, Kramer Electronics does not warrant that the product covered hereby, including, without limitation, the technology and/or integrated circuit(s) included in the product, will not become obsolete or that such items are or will remain compatible with any other product or technology with which the product may be used.

How Long this Coverage Lasts

The standard limited warranty for Kramer products is seven (7) years from the date of original purchase, with the following exceptions:

1. All Kramer VIA products are covered by a standard three (3) year warranty for VIA hardware and a standard one (1) year warranty for firmware and software updates. (An extended software warranty plan for an additional 2 years can be purchased separately).
2. All Kramer fiber optic cables and adapters, all Kramer speakers and Kramer touch panels are covered by a standard one (1) year warranty.
3. All Kramer Cobra products, all Kramer Calibre products, all Kramer Minicom digital signage products, all HighSecLabs products, all streaming, and all wireless products are covered by a standard three (3) year warranty.
4. All Sierra Video MultiViewers are covered by a standard five (5) year warranty.
5. Sierra switchers & control panels are covered by a standard seven (7) year warranty (excluding power supplies and fans that are covered for three (3) years).
6. K-Touch software is covered by a standard one (1) year warranty for software updates.
7. All Kramer passive cables are covered by a ten (10) year warranty.

Who is Covered

Only the original purchaser of this product is covered under this limited warranty. This limited warranty is not transferable to subsequent purchasers or owners of this product.

What Kramer Electronics Will Do

Kramer Electronics will, at its sole option, provide one of the following three remedies to whatever extent it shall deem necessary to satisfy a proper claim under this limited warranty:

1. Elect to repair or facilitate the repair of any defective parts within a reasonable period of time, free of any charge for the necessary parts and labor to complete the repair and restore this product to its proper operating condition. Kramer Electronics will also pay the shipping costs necessary to return this product once the repair is complete.
2. Replace this product with a direct replacement or with a similar product deemed by Kramer Electronics to perform substantially the same function as the original product.
3. Issue a refund of the original purchase price less depreciation to be determined based on the age of the product at the time remedy is sought under this limited warranty.

What Kramer Electronics Will Not Do Under This Limited Warranty

If this product is returned to Kramer Electronics or the authorized dealer from which it was purchased or any other party authorized to repair Kramer Electronics products, this product must be insured during shipment, with the insurance and shipping charges prepaid by you. If this product is returned uninsured, you assume all risks of loss or damage during shipment. Kramer Electronics will not be responsible for any costs related to the removal or re-installation of this product from or into any installation. Kramer Electronics will not be responsible for any costs related to any setting up this product, any adjustment of user controls or any programming required for a specific installation of this product.

How to Obtain a Remedy Under This Limited Warranty

To obtain a remedy under this limited warranty, you must contact either the authorized Kramer Electronics reseller from whom you purchased this product or the Kramer Electronics office nearest you. For a list of authorized Kramer Electronics resellers and/or Kramer Electronics authorized service providers, visit our web site at www.kramerav.com or contact the Kramer Electronics office nearest you.

In order to pursue any remedy under this limited warranty, you must possess an original, dated receipt as proof of purchase from an authorized Kramer Electronics reseller. If this product is returned under this limited warranty, a return authorization number, obtained from Kramer Electronics, will be required (RMA number). You may also be directed to an authorized reseller or a person authorized by Kramer Electronics to repair the product.

If it is decided that this product should be returned directly to Kramer Electronics, this product should be properly packed, preferably in the original carton, for shipping. Cartons not bearing a return authorization number will be refused.

Limitation of Liability

THE MAXIMUM LIABILITY OF KRAMER ELECTRONICS UNDER THIS LIMITED WARRANTY SHALL NOT EXCEED THE ACTUAL PURCHASE PRICE PAID FOR THE PRODUCT. TO THE MAXIMUM EXTENT PERMITTED BY LAW, KRAMER ELECTRONICS IS NOT RESPONSIBLE FOR DIRECT, SPECIAL, INCIDENTAL OR CONSEQUENTIAL DAMAGES RESULTING FROM ANY BREACH OF WARRANTY OR CONDITION, OR UNDER ANY OTHER LEGAL THEORY. Some countries, districts or states do not allow the exclusion or limitation of relief, special, incidental, consequential or indirect damages, or the limitation of liability to specified amounts, so the above limitations or exclusions may not apply to you.

Exclusive Remedy

TO THE MAXIMUM EXTENT PERMITTED BY LAW, THIS LIMITED WARRANTY AND THE REMEDIES SET FORTH ABOVE ARE EXCLUSIVE AND IN LIEU OF ALL OTHER WARRANTIES, REMEDIES AND CONDITIONS, WHETHER ORAL OR WRITTEN EXPRESS OR IMPLIED. TO THE MAXIMUM EXTENT PERMITTED BY LAW, KRAMER ELECTRONICS SPECIFICALLY DISCLAIMS ANY AND ALL IMPLIED WARRANTIES, INCLUDING, WITHOUT LIMITATION, WARRANTIES OF MERCHANTABILITY AND FITNESS FOR A PARTICULAR PURPOSE. IF KRAMER ELECTRONICS CANNOT LAWFULLY DISCLAIM OR EXCLUDE IMPLIED WARRANTIES UNDER APPLICABLE LAW, THEN ALL IMPLIED WARRANTIES COVERING THIS PRODUCT, INCLUDING WARRANTIES OF MERCHANTABILITY AND FITNESS FOR A PARTICULAR PURPOSE, SHALL APPLY TO THIS PRODUCT AS PROVIDED UNDER APPLICABLE LAW.

IF ANY PRODUCT TO WHICH THIS LIMITED WARRANTY APPLIES IS A "CONSUMER PRODUCT" UNDER THE MAGNANUS-MOSS WARRANTY ACT (15 U.S.C.A. §2301, ET SEQ.) OR OTHER APPLICABLE LAW, THE FOREGOING DISCLAIMER OF IMPLIED WARRANTIES SHALL NOT APPLY TO YOU, AND ALL IMPLIED WARRANTIES ON THIS PRODUCT, INCLUDING WARRANTIES OF MERCHANTABILITY AND FITNESS FOR THE PARTICULAR PURPOSE, SHALL APPLY AS PROVIDED UNDER APPLICABLE LAW.

Other Conditions

This limited warranty gives you specific legal rights, and you may have other rights which vary from country to country or state to state.

This limited warranty is void if (i) the label bearing the serial number of this product has been removed or defaced, (ii) the product is not distributed by Kramer Electronics or (iii) this product is not purchased from an authorized Kramer Electronics reseller. If you are unsure whether a reseller is an authorized Kramer Electronics reseller, visit our web site at www.kramerav.com or contact a Kramer Electronics office from the list at the end of this document.

Your rights under this limited warranty are not diminished if you do not complete and return the product registration form or complete and submit the online product registration form. Kramer Electronics thanks you for purchasing a Kramer Electronics product. We hope it will give you years of satisfaction.

KRAMER



P/N: 2900-300523



Rev: 1



SAFETY WARNING

Disconnect the unit from the power supply before opening and servicing

For the latest information on our products and a list of Kramer distributors, visit our Web site where updates to this user manual may be found.

We welcome your questions, comments, and feedback.

www.KramerAV.com
info@KramerAV.com