

DM 41

COMPACT 2 WAY SPEAKER



MAIN APPLICATIONS

- Music applications
- Audio visual applications
- Shopping malls
- Restaurants
- Pubs
- Hotels
- Office building

DESCRIPTION

DM 41 is a compact two way speaker designed for constant voltage systems. The speaker provide natural, smooth sound reproduction ideal for use in business music systems and indoor/outdoor background music applications. This loudspeaker has inside a transformer that allows the connection to a 100 V constant voltage line. When connected to a 100 V line, its power can be selected among the values 15 W, 10 W , 5 W or 2,5 W through a rotary switch (thanks to internal transformer taps). The enclosure includes a protective perforated grille and an accessory for the wall mounting.

MAIN FEATURES

- Woofer 3.5" mylar
- 1" dome tweeter
- 15 / 30 Watt (RMS/Music Power)
- 100 Hz ÷ 20 kHz
- 102 dB (1 m / POWER MAX) max. SPL
- Incl. 100V transformer multitap
- Power rotary switch
- Crossover frequency: 2500 Hz
- Type of filter 6 dB/oct
- Easy to install
- Simple power settings

SPECIFICATIONS

Loudspeaker	Woofer 3.5" mylar, 1" tweeter
Power (on 8 Ohm load)	15 / 30 W (RMS / Music power)
Power	15 W - 10 W - 5 W - 2.5 W (100V)
Sensitivity	87 dB (1 W / 1 m)
Mx. SPL (6 W / 1 m)	102 dB(A) (1 m / POWER MAX)
Frequency Response	100 Hz - 20 kHz
Angle of coverage	180° / 120° / 90° @ 1 / 2 / 4 kHz
Connector	2 conductor cable
Body colour	White Ivory RAL 9002
Main body material	Auto-extinguishing high-density polystyrene
Grill material	Steel
Dimensiones (HxWxD)	130 mm x 197 mm x 115 mm
Installation	Aluminium U bracket
Max ceiling thickness	35 mm
Net weight	1.8 kg
Operating temperature	-25° to +55°
Relative humidity	90% non condensing



DM 41

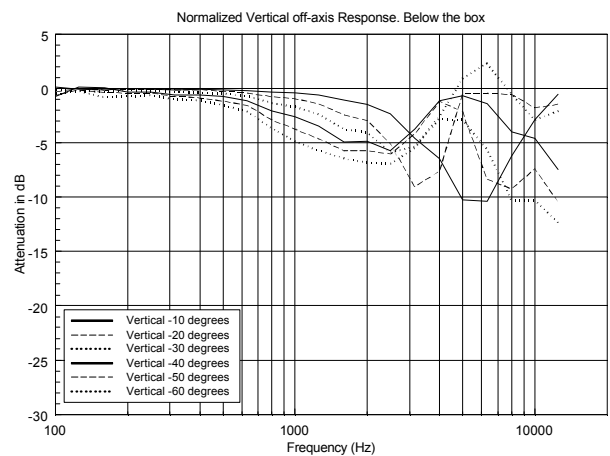
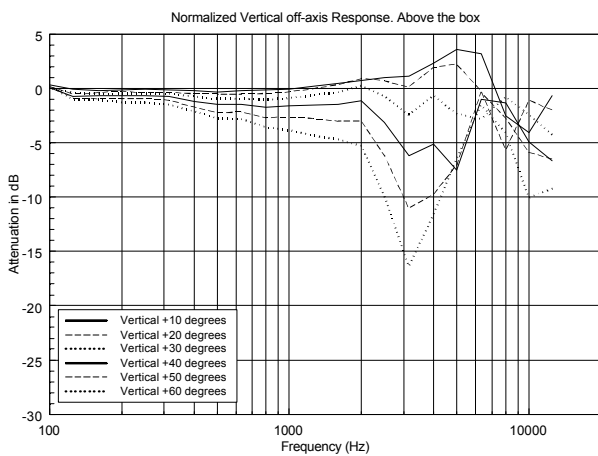
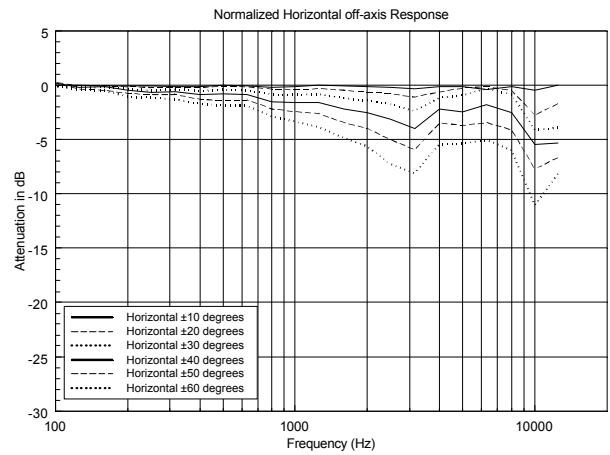
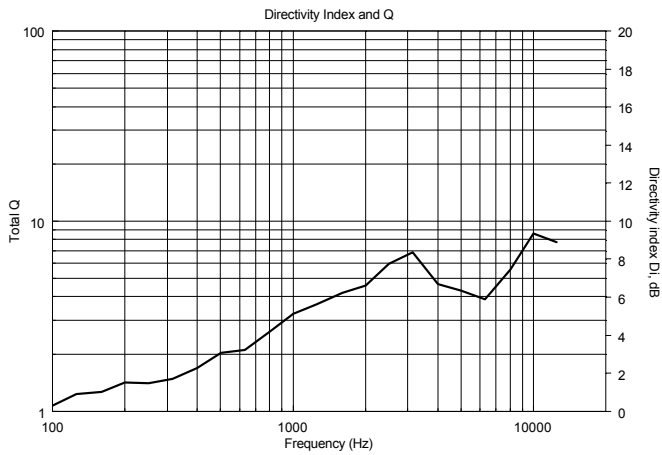
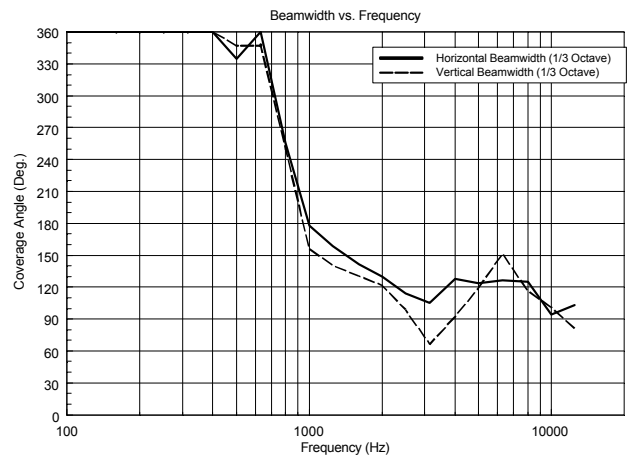
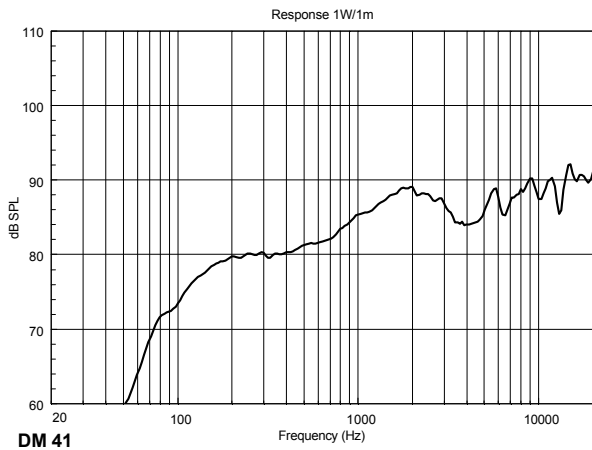

DM 41

HORIZONTAL 1/3 POLAR PLOT

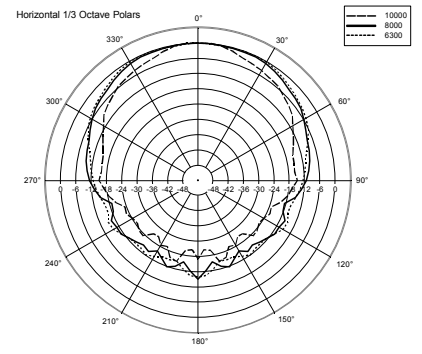
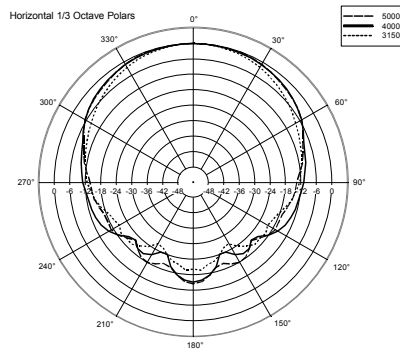
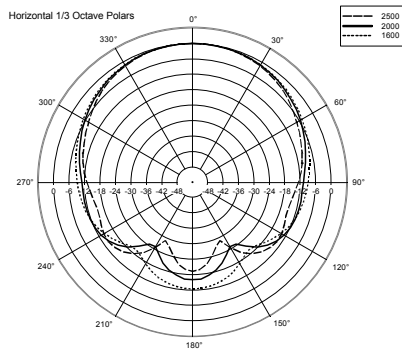
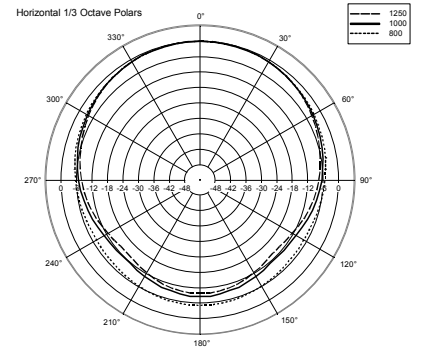
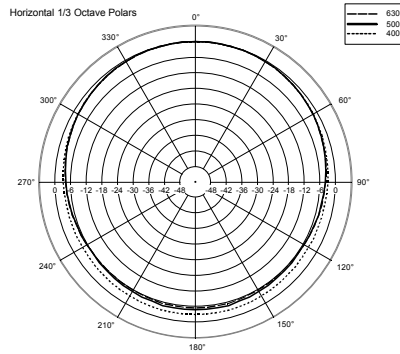
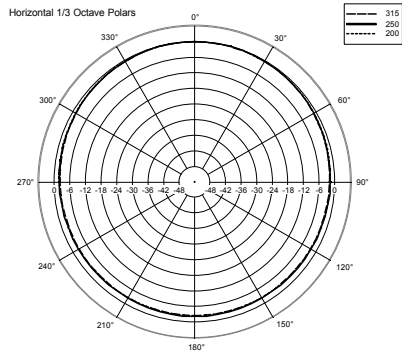

VERTICAL 1/3 POLAR PLOT

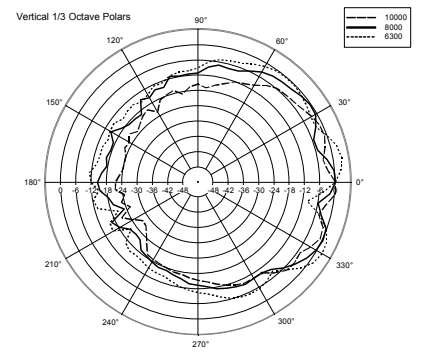
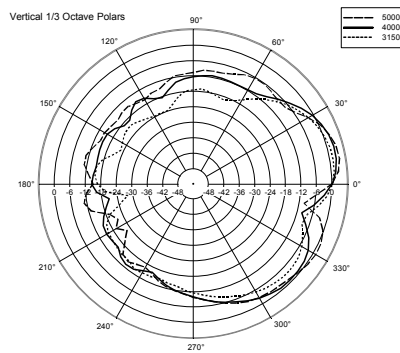
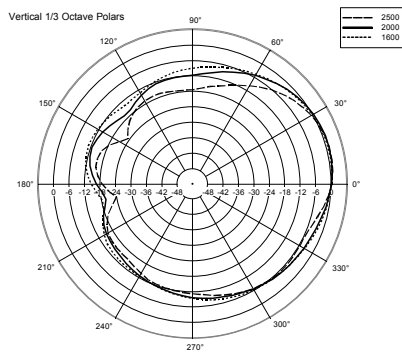
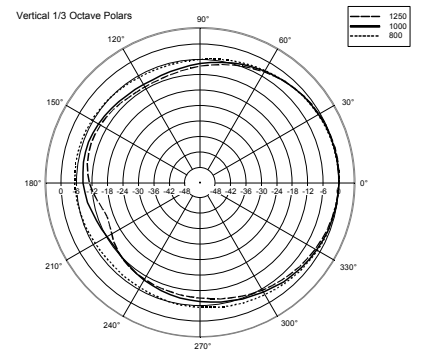
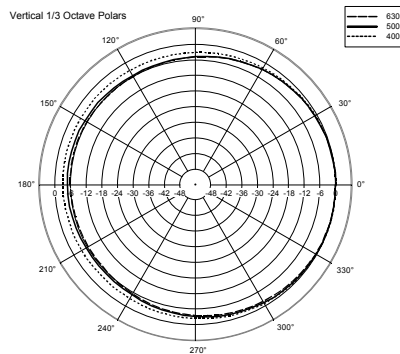
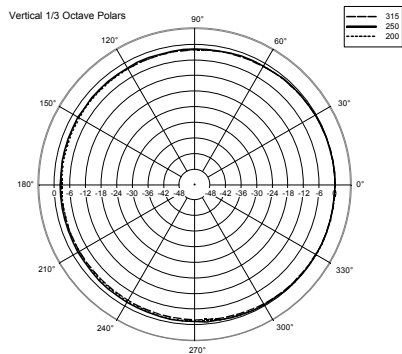

DM 41

PART NUMBERS

13000139 - MQ 50I-W White
13000140 - MQ 50I-S Silver

DIMENSIONS (All data are in mm)

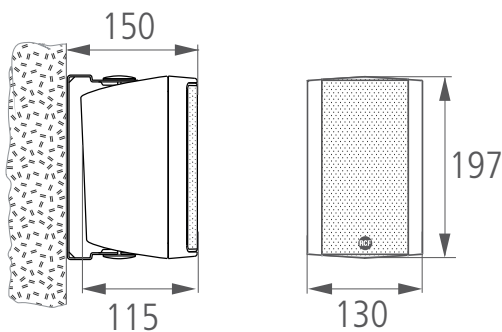

SCHEMATICS

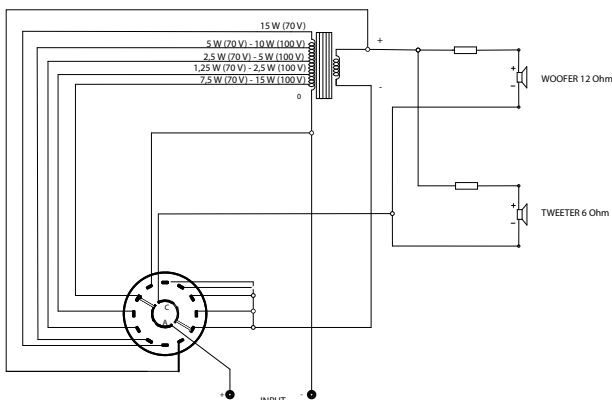

INSTALLATION NOTES

Installation of the DM 41 is quick thanks to the unique bracket connect to the speaker with two plugs.

Connections to the loudspeaker line are made by using the two wire cable coming out from the loudspeaker rear side.

The power can be easily selected by using the Rotary switch present on the back side of the speaker; the knob is accessible using fingers.

The enclosure is constructed of high density UV resistant self-extinguishing polystyrene with robust steel grill. The DM 41 is intended for both indoor and outdoor installations.

RCF products are continually improved. All specifications are therefore subject to change without notice.

POWER SELECTION

Set the rotary switch to selected the chosen power value referring to the 100 V line (among 2.5 W – 5 W – 10 W – 15 W) so the correspondence impedance (among 4000 Ω – 2000 Ω – 1000 Ω – 666 Ω)

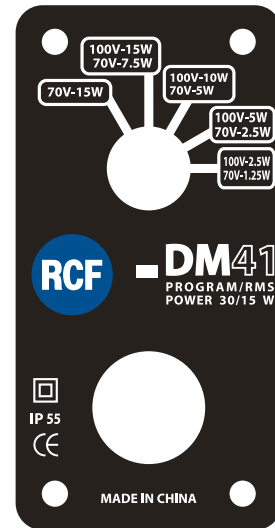

CERTIFICATIONS AND APPROVALS

- CE comply with European Community Directive 73/23/EEC and 93/768/EEC
- Environmental protection IP 55 homologation
- Self-Extinguishing plastic according to UL 94V0
- Speaker data according to IEC 268-5
- Safety according to IEC EN 60065:2002

ACCESSORIES (included)

- U bracket and accessories
- Steel Grill



www.rcf.it